



# Engine Air Filtration

for Light, Medium, &  
Heavy Dust Conditions

Air Cleaners • Pre-cleaners & Inlet Hoods • Rubber Adapters/Elbows • Filter Indicators • Mounting Bands



No matter the dust conditions or engine airflow requirements, you will find a Donaldson air cleaner or intake system accessory that will deliver clean air when your engine needs it most!

Distributed by:

# Total Filtration Solutions

Vehicles • Engines • Equipment

[donaldson.com](http://donaldson.com)

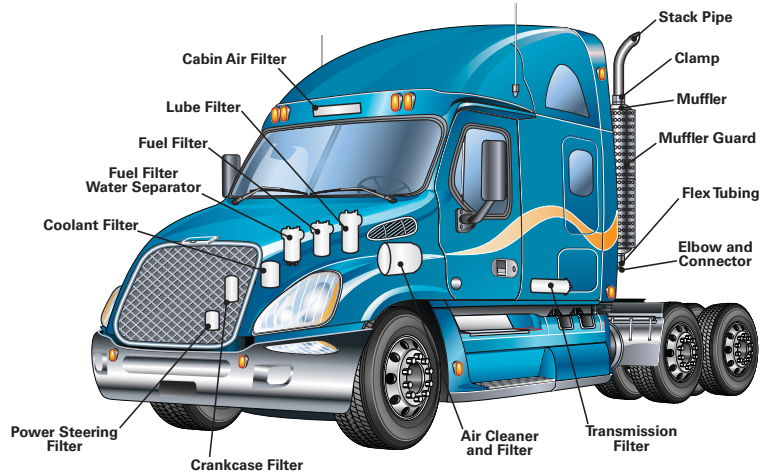
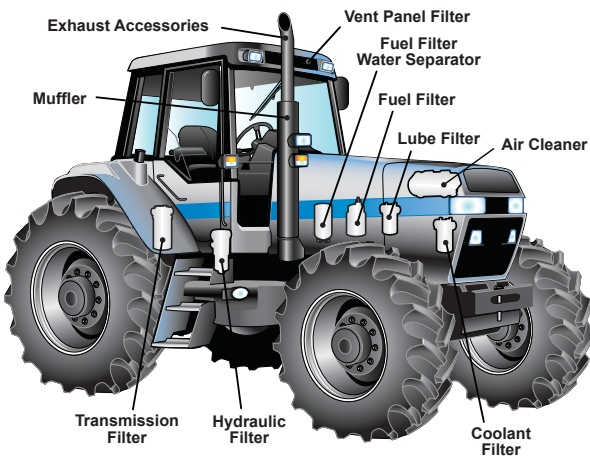
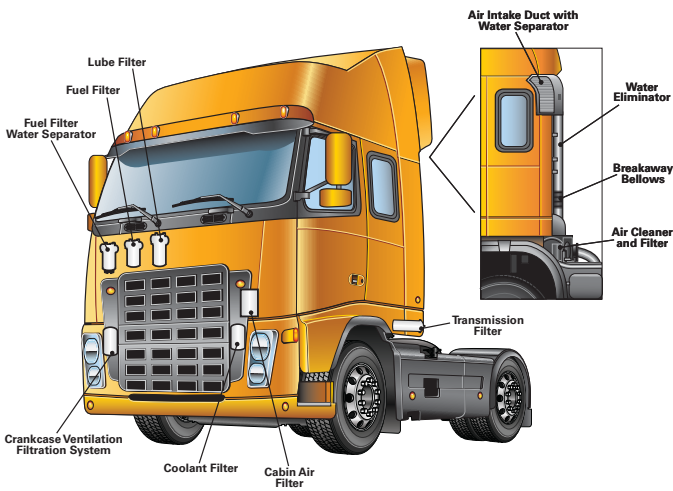
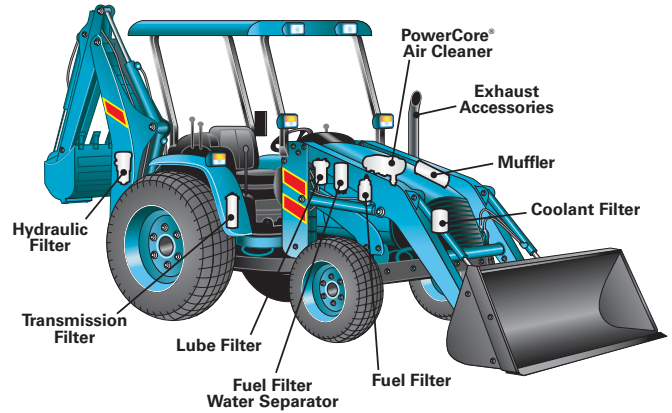

This publication contains a wide selection of standard, in-stock air cleaner models for both original equipment manufacturers and replacement parts vehicles, and equipment that operate in light to heavy dust conditions. For a variation or a custom designed intake system, please call your current supplier of Donaldson products.

<b>Overview .....</b>	<b>1</b>
Donaldson Air Intake Innovation.....	2
Air Cleaners.....	3
Air Filters.....	3
Air Cleaner Evolution .....	4
Air Filter Features .....	6
Donaldson Blue® Air Filters .....	7
Pre-Cleaner Technology .....	9
Air Cleaner Selection.....	10
<b>Competitive Fit Replacement Air Filters .....</b>	<b>12</b>
Mann+Hummel® Entaron Replacement.....	13
Mann+Hummel® Europiclon® Replacements .....	14
Mann+Hummel® Picoflex® Replacements .....	16
Fleetguard® Direct Flow™ Replacements.....	18
Fleetguard® OptiAir™ Replacements.....	20
<b>Disposable Air Cleaners .....</b>	<b>22</b>
DuraLite™ ECB, ECC, ECD.....	22
ECO® / ECOLITE® Air Cleaners .....	26
<b>PowerCore® Series.....</b>	<b>29</b>
PSD (Medium to Heavy Dust).....	30
PCD (Light Dust) .....	45
<b>PowerPleat .....</b>	<b>53</b>
<b>Light Dust — E Series .....</b>	<b>67</b>
EPG .....	68
ERA .....	74
EBA Konepac™ .....	79
ECG Konepac™ .....	84
EBB .....	90
<b>Medium Dust — F &amp; X Series .....</b>	<b>95</b>
FKB (Light to Medium Dust) .....	96
XRB .....	104
FPG .....	112
FRG .....	125
FTG .....	139
FVG Cycloflow™ .....	144
<b>Heavy Dust — S Series.....</b>	<b>149</b>
SSG Donaclone™ .....	150
STG Donaclone™ .....	160
SRG to SSG Conversion Kit.....	169
SRG Donaclone™ Service .....	170
STB Strata™ .....	174
<b>Air Intake Accessories .....</b>	<b>177</b>
<b>Air Cleaner Service Parts/Air Cleaner Upgrades...</b>	<b>219</b>
<b>Technical Reference .....</b>	<b>241</b>
<b>Engine Air Consumption Guide.....</b>	<b>289</b>
<b>Parts Listing by Number .....</b>	<b>297</b>

Fleetguard® is a registered trademark of Cummins, Inc.  
Mann+Hummel® and Europiclon® are registered trademarks of Mann+Hummel®  
ECO and ECOLITE are registered trademarks of Parker-Hannifin Corp., Racor Division

# AIR INTAKE INNOVATION

## – by Donaldson

Today's engines require *air intake systems* that can do more and last longer, often in increasingly smaller spaces.

They need to deliver:

- improved contaminant separation efficiency
- increased contaminant loading capacity
- low initial and overall airflow restriction
- lower overall system weight
- high temperature performance
- proven performance and durability.



### You get all of this and more with Donaldson air cleaners and filters.

We've been delivering air intake systems that have met equipment manufacturers' and customers' needs for more than 100 years. We've been the leader in air filtration since Frank Donaldson invented the first air cleaner for a tractor in 1915. Since then, we've continuously innovated and refined filtration solutions that help keep engines running, lasting longer, and performing better.

## Donaldson Air Intake Technologies

During the last century, we've developed new-to-the-world technologies that have set and redefined industry standards – keeping pace with evolving equipment technologies and customer requirements.

- **Donaldson RadialSeal™** systems replaced many axial or compression seal systems.
- **PowerCore®** air cleaners and its fluted filters have become the standard in many industries, replacing larger pleated air systems as space requirements have become tighter.
- Donaldson's latest air intake innovation, **PowerPleat™** is a highly-durable plastic RadialSeal air cleaner for equipment where space is not an issue, but performance is paramount.
- **Donaldson Blue®** filters with **Ultra-Web®** fine fiber media provides higher efficiency and greater contaminant-holding capacity than standard cellulose media.
- **Ultra-Web® HD** media now provides even higher filtration efficiency for extreme-dust mining and aggregate applications.

### For any air intake system need – Donaldson Delivers Power!



## Air Cleaners



**PowerCore®** An industry-changing air filtration system, PowerCore systems are more compact at a given performance level than standard pleated filters, and are used under the hood in on-road trucks and in many off-road applications.



**PowerPleat™** This lightweight, plastic two-stage air cleaner provides a flexible solution for a wide variety of applications, from lawn maintenance equipment to heavy-duty excavators.



**RadialSeal™** We pioneered RadialSeal technology for air filtration more than 20 years ago, when we created a superior seal and vibration-resistant interface between the air cleaner and filter.

### Axial Seal

**Axial Seal** A traditional air cleaner workhorse, axial seal systems are still prevalent on job sites and in on-road functions. An axial seal relies on compression, usually a wing nut or latched cover, to form an air-tight seal.

## Air Filters



**Donaldson Blue® air filters** offer the best technology for improved efficiency and enhanced engine and equipment protection. Users will also benefit from reduced maintenance costs and increased equipment uptime.



**Donaldson air filters** deliver superior protection for heavy-duty off-road and on-road equipment with a full line of premium filters, including those with PowerCore® filtration technology.



**Donaldson Competitive Fit** filters are manufactured as high-performing replacement filters for other manufacturers' air intake systems.

# Air Cleaner Evolution

## On-Road Housings

Bright Stainless Air Cleaner (Cowl Mount)

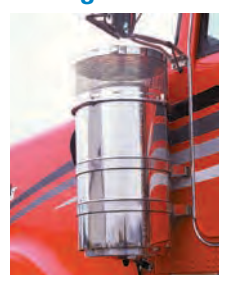

EPG RadialSeal™ Plastic Air Cleaner in engine compartment



Integrated Intake Systems with PowerCore® Filtration for underhood or behind cabs



## Off-Road Housings

Metal Two-Stage Air Cleaner



FRG RadialSeal™ Plastic / Metal Air Cleaner



PSD PowerCore® Lightweight Air Cleaner with non-metal filters



PowerPleat™ Lightweight Air Cleaner



## What's the Right Intake System?

As you develop the future design of your engine or application, it's important to consider the filtration system. Depending on your objectives, it may be beneficial to choose from a pre-configured catalog offering or to partner with Donaldson for a filtration solution tailored to your specific needs.

### Reasons to select a pre-configured system.

- Low budget for engineering collaboration, development time or cost, or component tooling.
- Prefer to have parts readily available — want to avoid manufacturing lead times (8 – 12 weeks) and not interested in warehousing service parts.
- Prefer an established configuration for service part access.

### Reasons to consider a custom, integrated system.

- Engine design team is integrating new components that require a higher degree of filtration.
- Looking for a system that does more, which may include pre-cleaning, sensors, unique intake plenums.
- Have budget for engineering collaboration, development time/cost.
- Interest in component / supplier consolidation — solutions that bridge a wide range of engine/vehicles.
- Offering a unique solution with ease of maintenance.

## Molded Plastic Intake Systems

### Under Hood Intake System

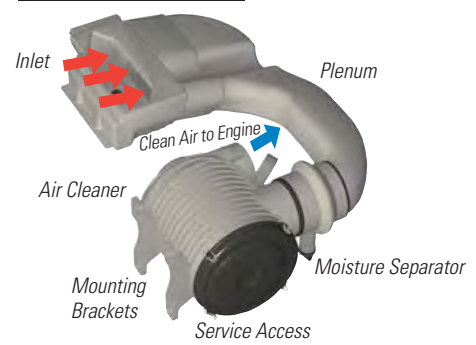

### Behind the Cab System

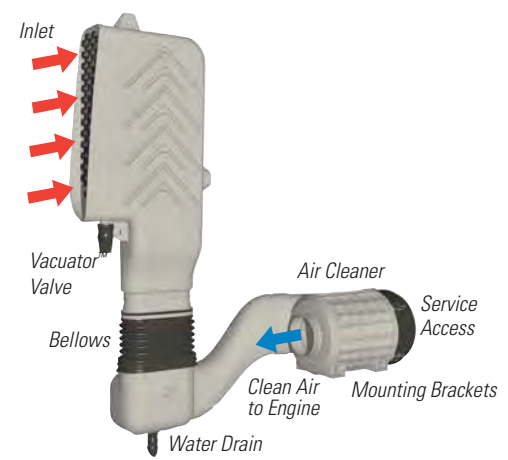

## PowerCore® Air Cleaner Technology

### Big Performance, Small Footprint

When air intake designs began requiring smaller, lighter and more efficient air intake solutions, PowerCore filtration systems became the leader, replacing countless pleated filter designs.

PowerCore Filtration Technology offers:

- greater system design flexibility
- metal-free, lightweight filters
- straight-through airflow technology invented by Donaldson
- superior filtration performance

To learn more about the PowerCore advantages, see the PowerCore section beginning on page 29.



PowerCore  
A Donaldson Filtration Technology



## PowerPleat™ Air Cleaner Technology

### Reliable Power, Smaller Size, Easy Integration

Donaldson PowerPleat air cleaners and filters offer equipment manufacturers and end users a powerful new filtration solution to protect engines from dust and contamination.

PowerPleat air intake systems offer:

- two-stage air filtration
- multiple inlet/outlet configurations
- all-plastic air cleaner housing (minus latches on larger sizes)

To learn more about the PowerPleat advantages, see the PowerPleat section beginning on page 53.



PowerPleat™  
A Donaldson Filtration Technology



## RadialSeal™ Air Cleaner Technology

### Superior Seal and Vibration Resistant Interface

This industry changing sealing technology combines two components into one — the end cap and sealing gasket. The flexible sealing material creates a sure-fit and simplifies filter maintenance. The reliable seal helps protect engines in extreme operating conditions and in challenging heavy-duty applications.



## Axial Seal Air Cleaner Technology

### Trusted Compression Seal

Axial seal style filters have a metal end cap with an attached gasket. This design requires housing cover pressure on the gasket to create the critical seal.



# Air Filter Features — Seals, Media, Beading, Liners

Technological advancements add up to big performance advantages.

## Pleatloc™ media spacing

Ensures uniform pleat spacing, keeps filter media from bunching during operation and promotes longer filter service life.

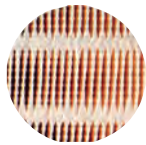

## Heavy-duty liners

Corrosion resistant, coated steel liners support the filter media during operation and maximize airflow.

## Beading

Applied to filter liners, beading is designed to stabilize the media and prevent pleat tip wear.

## Unique shapes

PowerCore® air filters come in a wide range of sizes and shapes, including these panel filters that fit in tight under-the-hood applications.



## RadialSeal™ filter seals

RadialSeal filters provide a tight critical seal that also slip easily on and off the outlet tube during installation and service. This design eliminates the separate gaskets used with metal end cap filters.



## Axial filter seals

Strong, pliable gasket ensures a leak-free seal when properly installed. The gasket won't harden or deteriorate over the useful life of the filter.

## Straight-through air flow

PowerCore® filters feature patented straight-through air flow that allows for reduced filter size and increased dust and soot holding capacity in a non-metal construction.



# Donaldson Blue® Air Filter Technology

## Air Filters with Ultra-Web® and Ultra-Web® HD

Donaldson Blue® premium air filters with Ultra-Web® and Ultra-Web® HD nanofiber technology protect engines by providing better initial and overall efficiency compared to conventional cellulose media.

- Advanced fine fiber filtration technology
- Invented by Donaldson
- Engineered to perform in extreme temperature and humidity conditions, unlike ordinary nanofibers
- Optimized fiber structure and fiber diameter so it's stronger and lasts longer in all environmental conditions
- High efficiency
- High capacity — holds more contaminant for longer filter life
- Identifiable by the blue media color
- Proven — used in diesel engines for more than two decades
- Ultra-Web HD provides even greater efficiency for heavy-duty, heavy-dust environments — like mining

**Donaldson**  
**BLUE**

## Donaldson Replacement Air Filters

### A higher standard for air filters

Our company founder, Frank Donaldson, designed and built the first air cleaner and filter for a heavy duty engine in 1915. Since then, nearly every significant innovation in air cleaner technology has been led by Donaldson. Today our air filters are setting new standards in filtration quality, coverage and performance – with filters that fit our own air cleaners and those manufactured by others. When you choose Donaldson air filters, you get performance that's anything but standard.

## Competitive Fit Air Filters

### Raising the bar for air filters

We manufacture replacement filters for popular air intake systems that meet or exceed application requirements.

Please see the Competitive Fit section, beginning on page 14, for details on replacement filters for Fleetguard® Direct Flow™, Fleetguard® OptiAir™, Mann+Hummel® Entaron, Mann+Hummel® Europiclone®, and Mann+Hummel® Picoflex®.



Fleetguard® is a registered trademark of Cummins, Inc.  
Mann+Hummel® and Europiclone® are registered trademarks of Mann+Hummel®

# Air Cleaner Materials, Finishes & Construction

## Designed for long life, rust resistance and good looks!

### Injection and Blow-Molded Air Cleaners

Our non-metal finish is always black plastic and can be found on DuraLite™, PowerPleat™, PowerCore® (PSD and PCD) and other RadialSeal™ air cleaners (FPG, XRB, FKB). Advantages include:

- Lighter weight than metal air cleaners
- Corrosion and chemical resistant
- Impact, mar and vibration resistant



*Injection and Blow-Molded Air Cleaners, e.g., PowerPleat, PowerCore*

### Polymer Coating Resists Corrosion

Donaldson's gloss black finish — on most of our metal air cleaners (ERA, FVG, FRG) — has the following advantages:

- Corrosion and chemical resistance. This polymer coating lasts five to 10 times longer than traditional paint.
- Impact and mar resistance. Polymer coating is up to 17 times harder than most solvent-based paint.
- Consistent coating thickness over the entire air cleaner, even in crevices and small, hard-to-reach places.



*Polymer Coating*

### Buff Prime Finish

Most SSG & STG air cleaners have a buff prime finish — ready for you to apply paint to match the overall look of your equipment. (Exception: the SRG to SSG conversion kit contains an upper unit that has a white polymer coating.)



*Buff Prime Finish*

# Pre-cleaner Technology

Pre-cleaners remove contaminant of varying sizes from entering the intake duct; they don't require any engine power to operate. Some devices collect the contaminant (Full-View), others just eject or drop the contaminant (TopSpin, Top Spin HD / in-line separator), or are connected via a scavenge system and route debris out the exhaust system (Donaspin / Strata Cap).

- Strata Cap and Donaspin are units for scavenge air system option for heavy dust condition operating environments. Additional components required for scavenge system (hoses, check valves, clamps and exhaust ejector)
- Pre-cleaners extend life of vehicle air filters and serve as rain caps
- Units are made of durable materials — either metal or impact resistant plastic
- Units install outside of engine compartment — leaving more space under hood for other components (exception-in-line separator)
- Pre-cleaners have no wires or power requirements
- Requires additional components for scavenge system (hoses, check valves, clamps and exhaust ejector)



Close-up of pre-cleaner section of a PowerCore® PSD air cleaner. Pre-cleaning tubes can be arranged in various patterns, depending on the space and efficiency requirements of your application.



Six pre-cleaner styles offer the broadest product range in the industry

## Quick Comparison

More characteristics about our pre-cleaner line. For more details, contact your local distributor or dealer.

Dust Condition	Max. Sepr Efficiency	Pre-Cleaner Family	Scavenge Required	Service Required	Material
Heavy	96%	Strata™ Cap	Yes	Yes	Plastic
	90%	Donaspin™	Yes	No	Steel
Medium	85%	TopSpin™	No	No	Plastic
	80%	TopSpin™ HD	No	No	Aluminum/ Stainless Steel
	70%	In-Line Separator	No	No	Steel
	75%	Full-View	No	Yes	Steel/Plastic

To learn more about Donaldson Accessories, see the Accessories section beginning on page 177.

Donaldson inertial particle separation technology offers maintenance-free air filtration for turbines, diesel engines and environmental applications. Inertial separation technology is used extensively on ground vehicles, rotorcraft, off-road vehicles and other critical equipment exposed to harsh environments.

Our light-weight pre-cleaning tubes have no moving parts to wear out or break. They are self-cleaning and do not require regular maintenance.

*Strata™ Tubes offer low airflow restriction with efficient contaminant removal of up to 99%.*

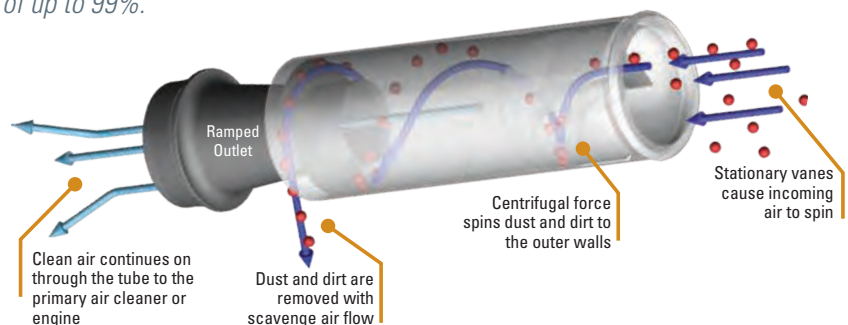

# Air Cleaner Selection

With the multitude of sizes and styles of air cleaners available from Donaldson, how do you choose the proper model that will reliably protect your engine and deliver maximum filter service life? Selection is based on two primary factors — airflow requirements of your engine and the environment the air cleaner will be operating in. Use our five-step selection method on the next few pages to make the right choice for your application:

## 1 Determine the combustion air requirements of the engine

For the most accurate engine airflow specifications, Donaldson recommends using the intake airflow rate specified by the engine manufacturer. If this information is not readily available, you can calculate your own numbers by using the preferred or alternative methods shown below. If the air cleaner will experience excessive engine vibration, include a pulsation factor into your calculations.

### Ideal Method Obtain from Engine Manufacturer

For the most accurate engine airflow specifications, Donaldson recommends using the intake airflow rate specified by the engine manufacturer.

### Preferred Method Engine Displacement Formula

#### 4-Stroke (Cycle) Engine Formula

##### English Units

$$\text{Airflow (CFM)} = (\text{Engine Size (CID)} \times \text{RPM}) \times \text{VE} / 3456$$

##### Metric Units

$$\text{Airflow (m}^3/\text{min)} = (\text{Engine Size (Liters)} \times \text{RPM}) \times \text{VE} / 2000$$

##### VE = Volumetric Efficiency — 4-Stroke\*

- 0.90 for naturally aspirated gas engine
- 0.90 for naturally aspirated diesel engine
- 1.60 for turbo charged diesel engine
- 1.85 for turbo charged after cooled diesel engine

#### 2-Stroke (Cycle) Engine Formula

##### English Units

$$\text{Airflow (CFM)} = (\text{Engine Size (CID)} \times \text{RPM}) \times \text{VE} / 1728$$

##### Metric Units

$$\text{Airflow (m}^3/\text{min)} = (\text{Engine Size (Liters)} \times \text{RPM}) \times \text{VE} / 1000$$

##### VE = Volumetric Efficiency — 2-Stroke\*

- 0.90 for naturally aspirated diesel engine
- 1.40 for scavenge blower diesel engine
- 1.90 for turbo charged diesel engine

\* The VE values are guidelines. It is always best to use manufacturer ratings when they are available. Electronic controls on modern engines can raise VE ratings to 2.0 or greater.

## Alternative Method Engine Horsepower Formula

### English Units

$$\text{Airflow (CFM)} = \text{HP (SAE)} \times \text{SA}$$

#### SA = (Specific Airflow) per Horsepower

- 4-stroke naturally aspirated diesel engine — 2.0
- 4-stroke turbo charged diesel engine — 2.3
- 4-stroke turbo charged after cooled diesel engine — 2.3

- 2-stroke naturally aspirated diesel engine — 2.0
- 2-stroke scavenge blower diesel engine — 3.3
- 2-stroke turbo charged diesel engine — 3.6

### Metric Units

$$\text{Airflow (m}^3/\text{min)} = \text{HP (SAE)} \times \text{SA}$$

#### SA = (Specific Airflow) per Horsepower

- 4-stroke naturally aspirated diesel engine — 0.057
- 4-stroke turbo charged diesel engine — 0.065
- 4-stroke turbo charged after cooled diesel engine — 0.065

- 2-stroke naturally aspirated diesel engine — 0.057
- 2-stroke scavenge blower diesel engine — 0.093
- 2-stroke turbo charged diesel engine — 0.102

## The Pulsation Factor (PF)

On naturally aspirated\*\* engines, intake airflow to the air cleaner can negatively affect the cubic displacement of the air into the engine. To compensate for the loss, we recommend you multiply the engine airflow by one of the following factors:

#### English Units

- 2.1 for 1 cyl.
- 1.5 for 2 cyl.
- 1.2 for 3 cyl.
- 1.0 for 4 or more cyl.

#### Metric Units

- 1,2 m<sup>3</sup>/min.

## 2 Determine the dust condition for the engine/machine and typical operating environment

For example, a standby hospital generator set would probably see light dust; whereas, a rock crusher would almost always be surrounded by an extremely heavy dust concentration of large dirt particles. Our air cleaner selection chart, on the next page, is a visual guide to select your vehicle type and operating environment.

\*\* No airflow adjustment is required for turbo-charged engines on Donaldson air cleaners with high pulsation filter media (e.g., Donaldson DuraLite™ ECB, ECC, ECD air cleaners).



# Air Cleaner Selection

## 3 Select an air cleaner series

Key design differences are color coded in our selection chart including PowerPleat™, PowerCore® filtration technology, RadialSeal™ axial seal, and disposable air cleaners.



Application notes, dimensional, locations of the inlet and outlet, and mounting configurations are appropriately considered at this step. These parameters are sometimes critical and may lead you to an alternative model or series that is better suited to your application.

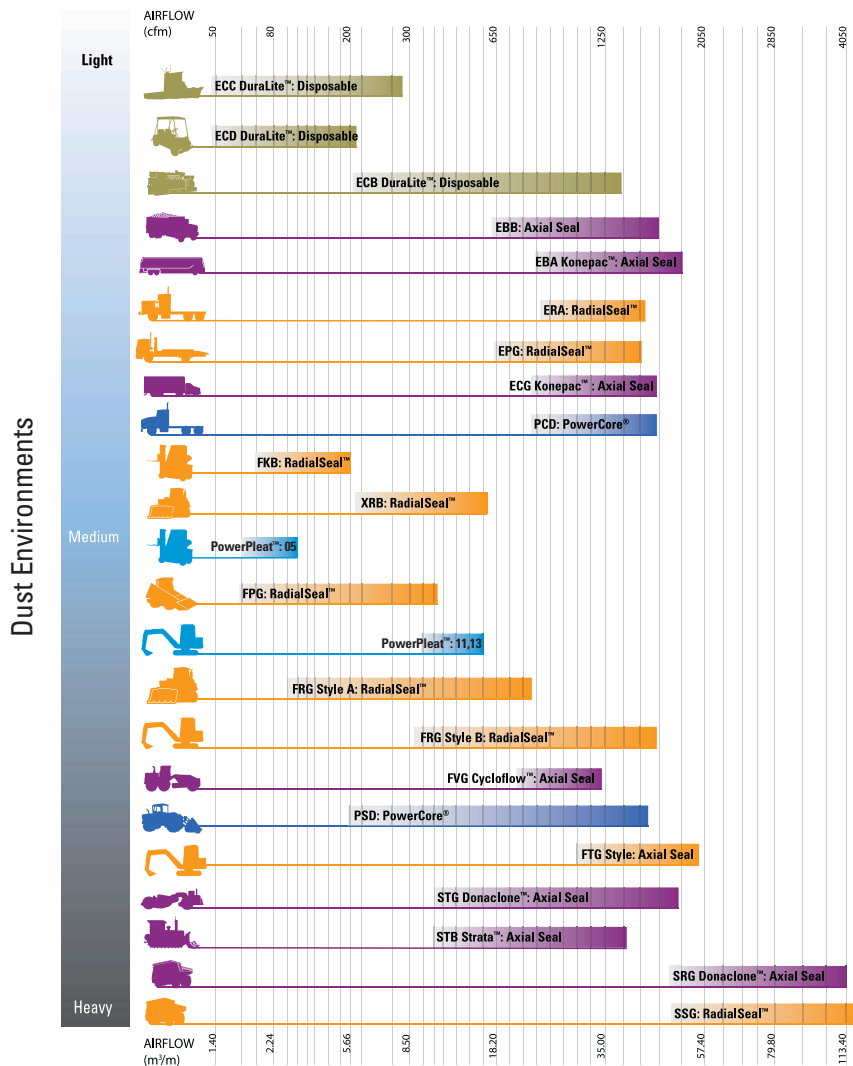

Go to [donaldson.com](http://donaldson.com) and search for Air Cleaners to see our online air cleaner selection tool.

## 4 Choose a specific air cleaner family or series

Use the table of contents from this guide to locate the choices for a particular air cleaner family according to the cfm your engine needs. Refer to the Initial Airflow Restriction table for the style you're considering. If there are two air cleaner models that fit your parameters, choose the one with the **lowest** restriction to ensure maximum service life from that air cleaner/filter.

## 5 Choose intake accessories

Even though they're called accessories, things like inlet hoods, mounting bands, rubber connectors, and clamps are important parts of the overall intake system. See our accessories section for more information.

# Filter Minder® — the Most Trusted Name in Service Indicators — now available through Donaldson



Filter Minder® Products are the most trusted line of service indicators and switches available. They help you maximize equipment efficiency, uptime and performance.

Filter Minder® indicators, switches, and sensors are now available through thousands of Donaldson distributors around the world.

Filter Minder® offers the broadest and most comprehensive portfolio of air-intake monitoring technologies featuring multiple indicator types, mounting configurations and fitting styles.

To learn more about the Filter Minder and restriction indicators advantages, see the Indicator section beginning on page 196.

## SSG Conversion Kit for SRG Air Cleaner



### SSG Style — Our Largest Engine Air Cleaner

The SSG Air Cleaner offers design improvements over our older SRG air cleaner style — including filters with RadialSeal™ sealing technology, and a filter access cover with a quick release cover latches and chain.

### Upgrade to newer filtration technology . . . with our Conversion Kit

Replacing an older SRG housing with the new SSG housing allows you to simplify your routine filter service — no more separate gaskets at each filter change or removing a bolted on cover. SSG filters have RadialSeal end caps that provide a more reliable, consistent seal.



No more bolt to unscrew for a filter change — simply unlatch the cover and let it hang from the housing during service.



Conversion kit includes all you need to replace the upper unit of an old SRG air cleaner, including the filters.

Choose from an upper assembly conversion kit or you may want to install a complete new housing if your current SRG assembly needs repair or is reaching the end of its useful life. See page 169 for details.



Note: Extra lead time may be required for processing and shipping.

# Filtration Solutions

## Global Capabilities — Design & Logistics

Donaldson has accumulated numerous engineering, design, and testing tools that are used during the design process.

### Engineering Capabilities

- Design centers in three key regions — United States, Asia and Europe

#### Prediction and Simulation

- CAD
- Proprietary, internally developed filter modeling software
- Fundamental fluid mechanics
- Computational fluid dynamic methods
- Structural analysis
- Thermal analysis

### Development and Validation

#### Analytical Evaluation

- Particle Characterization
- Chemical Analysis Laboratory
- Acoustic Analysis

#### Filter Durability

- Filtration performance testing per applicable SAE and ISO standards
- Fabrication integrity
- Environmental conditions
  - Salt spray and thermal cycling
- Pressure fatigue
- Flow fatigue
- Hydrostatic burst
- Flow benches
- Vibration benches
- Gravimetric analysis

#### Rapid Prototyping

- SLA, SLS, FDM, CLIP
- Investment casting
- RTV molding

### Test & Evaluation Tools

#### Structural Analysis

- Per SAE, ISO, and NFPA standards
- Ansys & Abaqus
- Collapse
- Pressure impulse and fatigue

#### Tensile Compression

- Test material, component and assembly properties

#### Environmental Chambers

- Hot or cold temperature, with humidity control

#### Flow Test Benches

- Measurement of static and dynamic flow and restriction for a device
- Calculation of device restriction at varying flows and temperatures
- System simulation

#### Performance Testing

- ISO, SAE, NFPA
- Filter performance
- Efficiency testing
  - Gravimetric
  - Fractional
- Capacity testing per ISO5011
- Customer standards
- Crankcase ventilation tests
- Soot loading bench
- MAFS Test Bench
- Acoustic Test Chambers

### Design Validation

#### Diesel Engine Test Cells

- Test cell locations in three key regions — United States, Asia and Europe
- Up to 600 kW / 800 hp capability
- Measurement of gaseous and particulate emissions
- Component durability
- Soot test bench
- 24/7 durability testing
- Web-based test cell monitoring access
- Tensile/Compression Tester
- Temperature Chambers

#### Vibration/Shaker

- Multiple systems capable of combined vibration and hot/cold thermal testing
- Vibration with flow test
- Sine, random, multi-mode, and shock profiles
- Can develop accelerated vibration schedules for specific applications using nCode Glyphworks

#### Field Testing

- On and off highway
- Heavy-duty
- End user and OEM vehicles

#### Field Data Acquisition

- Real time measurements
- Remote communications
- On-line collection tools
- Analyze operational trends

### Filter Media

- Wide selection
- Media characterization testing
- In-house media capabilities



# Donaldson Offers Air Filters for Most of Your Applications — including **Competitive Fit** Replacements



They may look a little different out of the box, but Donaldson competitive fit replacement air filters are specially designed to fit other manufacturer’s air cleaner housings used in both on- and off-road applications.

### Section Index

Mann+Hummel® Entaron Replacement.....	13
Mann+Hummel® Europiclon® Replacements .....	14
Mann+Hummel® Picoflex® Replacements.....	16
Fleetguard® Direct Flow™ Replacements.....	18
Fleetguard® OptiAir™ Replacements.....	20

Fleetguard® is a registered trademark of Cummins, Inc.  
Mann+Hummel® Picoflex® and Europiclon® are registered trademarks of Mann+Hummel®





# Proven protection for heavy-duty diesel engines

## Packed with proven technology

Equipped with Donaldson’s industry-shaping RadialSeal™ system, advanced media, and stable structural support, these air filters for Mann+Hummel® Entaron air cleaners are built to perform and provide effective engine protection, in a wide-range of challenging on- and off-road environments.



Donaldson Part No.	Mann + Hummel	Application example
<b>Primary Filter</b>		
<b>P629543</b>	C21600	Excavators

### Vibration Resistant

Innovative Dual Compression saw-tooth design incorporates an inventive combination of soft and hard urethane that generates high levels of compression – maintaining secure RadialSeal integrity. Filter resists movement (even under heavy vibration) and delivers sure sealing under the most severe duty conditions.

### RadialSeal™ design

Proven sure-fit Donaldson sealing system creates a reliable, vibration-resistant interface between the air cleaner and the filter. Slides easily on and off the outlet tube during servicing, making removal and replacement fast and simple.

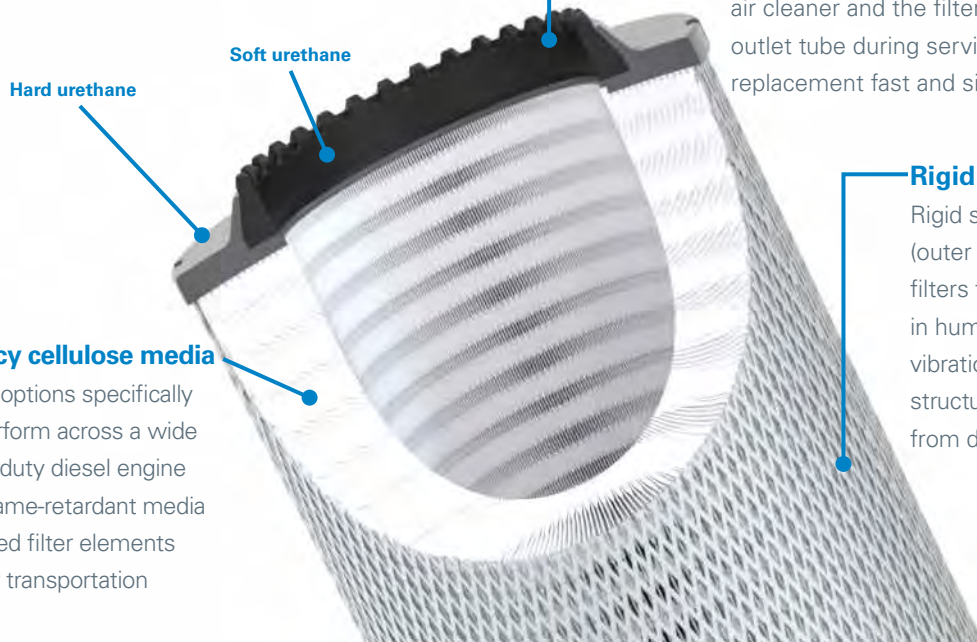

### High-efficiency cellulose media

Offering media options specifically designed to perform across a wide range of heavy-duty diesel engine applications. Flame-retardant media in UL Recognized filter elements are available for transportation applications.

### Rigid structural support

Rigid structural support system (outer or inner liners) protect filters from damage or collapse in humid conditions or heavy vibration applications. The structure also protects the media from damage during servicing.



# Superior, proven performance for heavy-duty diesel engines

## Packed with proven technology

Equipped with Donaldson's industry-shaping RadialSeal™ system, advanced media, and stable structural support, these air filters for Mann+Hummel<sup>®</sup> Europiclone<sup>®</sup> air cleaners are built to perform and provide effective engine protection, in a wide-range of challenging on- and off-road environments.



### Vibration Resistant

Innovative Dual Compression saw-tooth design incorporates an inventive combination of soft and hard urethane that generates high levels of compression – maintaining secure RadialSeal integrity. Filter resists movement (even under heavy vibration) and delivers sure sealing under the most severe duty conditions.

### RadialSeal™ design

Proven sure-fit Donaldson sealing system creates a reliable, vibration-resistant interface between the air cleaner and the filter. Slides easily on and off the outlet tube during servicing, making removal and replacement fast and simple.

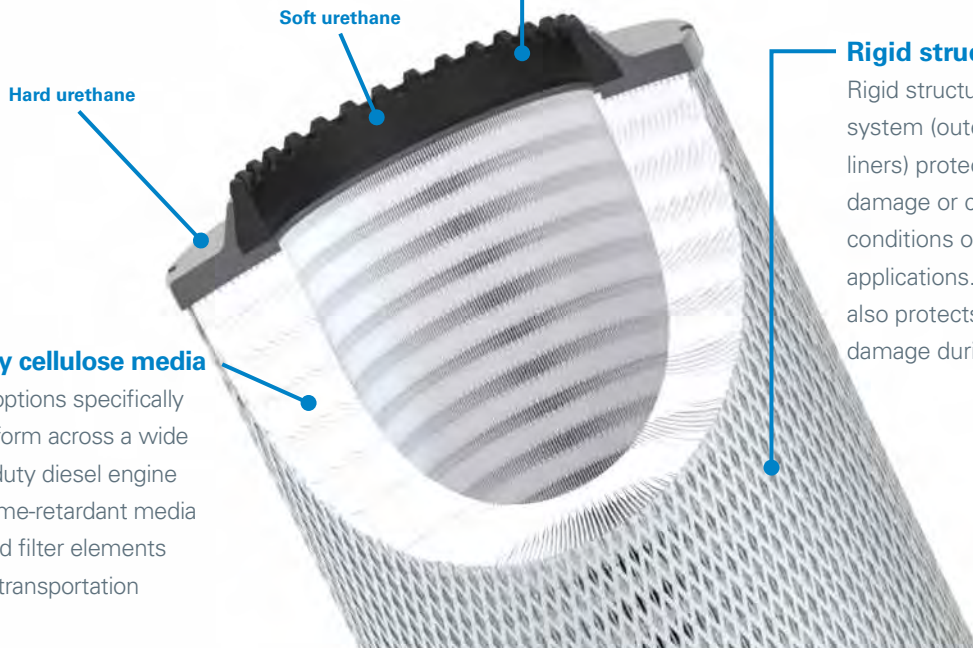

### Rigid structural support

Rigid structural support system (outer or inner liners) protect filters from damage or collapse in humid conditions or heavy vibration applications. The structure also protects the media from damage during servicing.

### High-efficiency cellulose media

Offering media options specifically designed to perform across a wide range of heavy-duty diesel engine applications. Flame-retardant media in UL Recognized filter elements are available for transportation applications.

Mann+Hummel<sup>®</sup> and Europiclone<sup>®</sup> are registered trademarks of Mann+Hummel<sup>®</sup>



## Europiclon® Replacement Part Numbers and Cross Reference

### PRIMARY FILTER CROSS REFERENCE

Donaldson Primary	Mann+Hummel	Baldwin	Fleetguard	Luber-finer	Wix
P778972	C16400	RS3922	AF26393	LAF9101	46818
P778979	C11100	RS3990	AF26387	—	49978
P778984	C14200	RS3942	AF26389	LAF8749	49462
P778989	C15300	RS3920	AF26391	LAF3947	46836
P778994	C20500	RS3992	AF26395	LAF2342	49131
P782104	C23610	RS3994	AF26397	LAF4601	49783
P782105	C257103	RS3996	AF26399	LAF6098	49711
P782106/ DBA5207**	C308103	RS3998	AF26401	LAF6998	49811
P782328	C259501	RS4562	AF25704	LAF5704	—
P782880*	C258606	RS4969	AF25876	LAF6682	—
P782881*	C256602	RS4968	AF25875	LAF6683	—
P782936*	C2712501	RS4971	AF25894	LAF6936	—
P784198*	C258605	RS5537	—	—	—
P784456	C2713202	RS5508	AF26202	—	—
P784457*	C2713203	RS5358	AF26242	LAF6242	—
P784525*	C2711704	RS4959	AF25975	—	—
P785352*	C3214202	RS5356	AF26241	LAF6689	—
P786421	C271170	RS5534	AF26246	LAF6246	49464
P789377	C261100	RS5488	AF26677	—	—

\*Flame retardant media

\*\*P782106 is available with Donaldson Ultra-Web® fine fiber as DBA5207



### SAFETY FILTER CROSS REFERENCE

Donaldson Safety	Mann + Hummel	Baldwin	Fleetguard	Luber-finer	Wix
P780012	CF400	RS3923	AF26394	LAF9100	46829
P780018	CF100	RS3991	AF26388	—	49968
P780024	CF200	RS3943	AF26390	LAF8750	49463
P780030	CF300	RS3921	AF26392	LAF3948	46837
P780036	CF500	RS3993	AF26396	LAF2343	49132
P782107	CF610	RS3995	AF26398	LAF4602	49782
P782108	CF710	RS3997	AF26400	LAF6099	49710
P782109	CF810	RS3999	AF26402	LAF6999	49810
P782937	CF1640	RS5361	AF25896	LAF6937	—





## Proven technology offers improved filter performance

### Donaldson PowerCore® provides proven protection for off-road environments

Off-road work environments, including construction and agriculture, are notoriously dirty, dusty, and downright filthy. Keeping a machine running smoothly and enabling it to perform longer between service intervals is vital. Downtime means an uptick in expenses.

Donaldson's new line of high-efficiency air filters for Mann+Hummel® Picoflex® air cleaner housings can help increase uptime by maintaining extended service intervals and providing effective and proven engine protection.



- **Performance\***

- Up to 18% lower initial restriction than OEM filter
- Matches OEM filter performance in efficiency and dust-holding capacity

- **Maintain Extended Service Intervals**

- Optimal dust-holding capacity allows for more engine uptime between filter changes, so you can keep engines running longer and spend less on filters

- **Proven PowerCore® Media**

- Rugged construction holds up in heavy-duty work environments
- Dust encapsulation makes servicing easier and cleaner
- More than 20 years of proven performance in diesel engines

\*Results generated using laboratory testing of P635903 pursuant to ISO5011. Actual performance during use may vary depending on multiple factors, including specific product configuration, external conditions, and application.





## Picoflex® Replacement Part Numbers, Cross Reference, and Applications

Donaldson Part No.	Mann + Hummel	Baldwin	Fleetguard	Luber-finer	Wix	Application examples
<b>Primary Filters</b>						
<b>P608766</b>	CP23210	CA4996	AF27873	LAF3236	49108	Backhoe Loaders
<b>P635903</b>	CP24420	–	–	–	–	Backhoe Loaders
<b>P635904</b>	CP29550	CA30071	AF1010	–	49501	Excavators
<b>Safety Filters</b>						
<b>P785965</b>	CF2135	PA4997	AF26248	LAF3237	49109	Backhoe Loaders
<b>P635979</b>	CF2550	–	–	–	–	Backhoe Loaders
<b>P635980</b>	CF2864	PA30072	AF1009	–	49502	Excavators



Mann+Hummel® and Picoflex® are registered trademarks of Mann+Hummel®



## The most powerful air filtration technology meets **sure seal** know how

**Donaldson Blue**® replacement filters incorporate **many** or our most advanced air filtration technologies into a complete package. They're specifically designed to fit and proven to perform in Fleetguard® Direct Flow™ air cleaners.

- **Proven** RadialSeal™ Sealing System
- **Proven** Ultra-Web® Nanofiber Media
- **Proven** PowerCore® or **Proven** Pleated Filter Design

Take charge of your engine protection. You have the power to choose the best filter for your Direct Flow air cleaners.

Choose **Donaldson Blue**.



# 50% more sealing area & 2x more gasket compression

## THAN FLEETGUARD® DIRECT FLOW™ AIR FILTERS

Donaldson Blue filters with RadialSeal technology deliver two sealing advantages compared the OEM filter. They contain **50% more sealing area** and **have up to two times more gasket compression** around the frame for a sure-fit seal.

Compare this to a thin O-ring design that offers 50% less sealing area and less compression, and it's easy to see why more sealing area and more compression seal is better when it comes to protecting engines.

Fleetguard® is a registered trademark of Cummins, Inc.



## Direct Flow™ Replacement Part Numbers, Cross Reference, and Applications

Primary Filters				
Donaldson Part No.	Fleetguard Part No.	Cummins Part No.	Application examples	
 <b>DBA5306</b>	AF55030	5310323	Bobcat Compact Loaders and Skid Steer Loaders w/Bobcat 2.4L	
 <b>DBA5307</b>			Bobcat Compact Loaders and Skid Steer Loaders w/Bobcat 3.4L	
 <b>DBA5290</b>	AF55020	5283826	JLG Telehandlers w/Cummins QSF 3.8 Cummins Power Unit w/Cummins QSB 3.3 Gehl Telehandlers w/Cummins QSF 3.8 Broderson Cranes w/Cummins QSB 3.3 Broderson Cranes w/Cummins QSF 3.8 Luigong Excavators w/Cummins QSB 4.5 Dressta Dozers w/Cummins QSF 3.8	
 <b>DBA5294</b>	AF55021	5288553	JLG Telehandlers w/Cummins QSB 4.5 Ottawa Yard Spotter w/Cummins QSB4.5 Vogele Finisher w/Cummins 4.5 Fletcher Roof Bolter DitchWich w/Cummins QSB 4.5 Hyster Forklift w/Cummins QSB 4.5 Vermeer Trencher w/Cummins QSB 4.5	
 <b>DBA5291</b>	AF55005	5261248	Ford F-750 w/Cummins QSB 6.7 Hyundai Excavators w/ Cummins QSB 6.7	
 <b>DBA5292*</b>	AF55014	5261249	Atlas Copco Drills w/Cummins QSK 15 Buhler Versatile Tractors w/Cummins QSX 11.9 Cummins Generator Sets Doosan Compressors Fletcher Drills Hitachi Wheel Loaders w/Cummins QSB 6.7 Hyster Forklifts w/Cummins QSB 6.7 Hyundai Loaders w/Cummins QSB 6.7 Hyundai Excavators w/Cummins QSB 6.7/QSX 11.9 Tigercat Feller Buncher Trackmobile Versatile Tractors Voegele Finishers w/Cummins QSB 6.7 Wirtgen Finishers w/Cummins QSL 9/QSX 15	
 <b>X011861 Kit</b> Quantity: 2 DBA5292 for the applications requiring <b>two</b> elements				
 <b>DBA5293</b>	AF55015	5261250	Buhler Versatile Tractors w/ Cummins QSL 9 Cummins Generator Sets w/ Cummins QSL 9 Hyster Material Handlers w/Cummins QSL 9/QSM11 Hyundai Excavators w/ Cummins QSL 9 Komatsu Excavators w/ Cummins QSL 9 Sennebogen Material Handlers w/ Cummins QSL 9 Taylor Lift Trucks w/ Cummins QSL 9 TigerCat Loaders w/ Cummins QSL 9 Wirtgen Finishers w/ Cummins QSL 9	
Safety Filters				
<b>P638062</b>	AF55320	5310325	See DBA5290 and DBA5294 for application examples	
<b>P638061</b>	AF55312	5310324	See DBA5290 and DBA5294 for application examples	
<b>P633483</b> for DBA5291, DBA5292 <b>X011872 Kit for X011861 Kit</b> Quantity: 2 P633483 for the applications requiring <b>two</b> elements	AF55308	5261251	See DBA5291 and DBA5292 for application examples	
<b>P633484</b> for DBA5293	AF55309	5261252	See DBA5293 for application examples	

Fleetguard® is a registered trademark of Cummins, Inc.



## Advanced technology delivers complete engine protection

### Packed with proven technology

Equipped with Donaldson's industry-shaping RadialSeal™ system, advanced media, and stable structural support, these air filters for Fleetguard® OptiAir™ air cleaners are built to perform and provide effective engine protection, in a wide-range of challenging on- and off-road environments.



#### Vibration Resistant

Innovative dual compression saw-tooth design incorporates a combination of soft and hard urethane that generates high levels of compression – maintaining secure RadialSeal integrity. Filter resists movement (even under heavy vibration) and delivers sure sealing under the most severe conditions.

#### RadialSeal™ Design

Proven sure-fit Donaldson sealing system creates a reliable, vibration-resistant interface between the air cleaner and the filter. Slides easily on and off the outlet tube during servicing, making removal and replacement fast and simple.

#### Fully Encapsulated Pleat Ends

Pleat ends are fully enclosed in urethane, providing a durable, leak-resistant seal, while maintaining airflow that meets OE filter performance.

#### Rigid Structural Support

Metal liners\* protect filters from damage or collapse in humid conditions, heavy vibration applications, or heavy dust-loading environments. The rugged structure also protects the media from damage during servicing.

\*Smaller filter sizes have outer liners and the larger filter sizes have inner and outer liners.

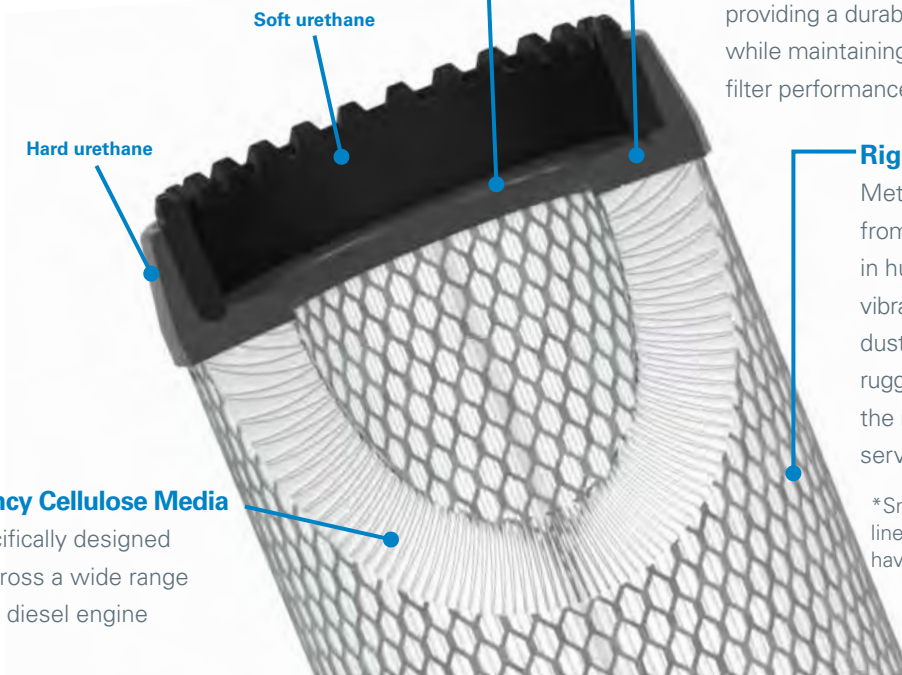

#### High-efficiency Cellulose Media

Media is specifically designed to perform across a wide range of heavy-duty diesel engine applications.

Cummins® Fleetguard® and OptiAir™ are registered trademarks of Cummins, Inc.



## OptiAir™ Replacement Part Numbers, Cross Reference, and Applications

PRIMARY FILTERS					
Donaldson Primary	Baldwin	Fleetguard	Luber-finer	Wix	Applications
P628323	—	AF26116	—	—	Fleetguard OptiAir 400 Series
P616641	RS5325	AF26168	LAF5325	49168	Fleetguard OptiAir 500 Series
P628325	—	AF26117	—	WA10162	Fleetguard OptiAir 600 Series
P628326	RS5745	AF25960	—	49021	Fleetguard OptiAir 800 Series
P628327	RS5749	AF26120	—	49035	Fleetguard OptiAir 1000 Series
P613334	RS4992	AF25962	LAF6922	46922	Fleetguard OptiAir 1100 Series
P617643	RS5429	AF26124	LAF6124	49148	Fleetguard OptiAir 1300 Series
P628324	RS5741	AF26364	—	49587	Bobcat Skidsteer
P628328	RS5747	AF27998	—	WA10035	Bobcat Loaders
P606503	RS4636	AF25707	LAF9099	46870	International 3532799C1
P613336	RS4862	AF26103	LAF6663	49088	International 3551814C1
P628329	RS5389FN	AF26104K	—	49029	International 3551816C1
P617646	RS5354	AF26337	LAF5354	49203	John Deere RE210102



Primary filter

SAFETY FILTERS						
Donaldson Safety	Baldwin	Fleetguard	Luber-finer	Wix	Applications	Filter type
P629463	—	AF26350	—	—	Fleetguard OptiAir 400 Series	Non-pleated
P629464	—	AF26351	—	49167	Fleetguard OptiAir 500 Series	Non-pleated
P629465	—	AF26118	—	—	Fleetguard OptiAir 600 Series	Non-pleated
P629466	RS5746	AF25961	—	49868	Fleetguard OptiAir 800 Series	Non-pleated
P629469	RS5750	AF26121	—	49036	Fleetguard OptiAir 1000 Series	Pleated
P613335	RS5329	AF25963	LAF6923	46923	Fleetguard OptiAir 1100 Series	Pleated
P617644	RS5430	AF26125	LAF6125	49149	Fleetguard OptiAir 1300 Series	Pleated
P629467	RS5742	AF26365	—	49588	Bobcat Skidsteer	Non-pleated
P629468	RS5748	AF27999	—	WA10045	Bobcat Loaders	Non-pleated
P613337	RS4863	AF26268	LAF6664	49089	International 3551815C1	Pleated
P609239	RS4637	AF25732	LAF9102	46871	International 3532800C1	Pleated
P617645	RS5355	AF26336	—	49103	John Deere RE210103	Pleated



Non-pleated safety filter



Pleated safety filter





## Convenient DuraLite™ Disposables

### Rugged Air Cleaners for Small and/or High Pulsation Gas & Diesel Engines

Donaldson's DuraLite Air Cleaners are tough, non-metallic, lightweight, self-supporting, and completely disposable. They are also easy to install, durable, and reliable.

They are designed to function well under high and severe pulsation conditions found in many applications, especially two- and three-cylinder engines. Vibration-resistant media is potted into molded housings of rugged ABS plastic — so they don't fall apart as other designs might.

### Applications

- Can be mounted vertically or horizontally
- Gas and diesel engines and hybrid vehicles in light to medium dust conditions
- Powered vehicles and equipment
- Mobile engines
  - Stepvans
  - Recreational vehicles
  - Lawn and garden tractors
- Stationary engines
  - Air compressors
  - Refrigeration units
  - Material handling equipment pumps
  - Gen sets
  - Welding equipment
- Marine engines
  - Propulsion units
  - Gen sets
- Provides variety of airflow volumes to engine: from 42 to 2118 cfm
- Temperature tolerance:
  - 180 °F/83 °C continuous
  - 220 °F/105 °C intermittent



Donaldson recommends the use of a high torque hose clamp (up to 150 in-lbs) for DuraLite air cleaners. This clamp eliminates the need for double clamping. Order one for each DuraLite air cleaner. See Accessories Section for more information.



*DuraLite™ Air Cleaners — sturdy, one-piece, and disposable — are designed to withstand the high pulsation of small engines such as the ones shown here. They are easy to maintain because there are no service parts. When the filter is full, simply throw it away.*



### Air Cleaner Features

- No serviceable parts. Air cleaner housing and filter are one unit.
- Designed to withstand severe intake pulsation
- Economical replacement cost
- Self-supporting, sturdy
- Very reliable: only one critical seal
- Lightweight and compact in size
- Non-metallic (except B085008 which is galvanized steel), non-corrosive . . . ideal for marine applications
- Completely disposable . . . acceptable for normal trash pick-up (DuraLite should not be incinerated)
- Easily installed and maintained
- Minimal removal clearance needed — only 1.5"
- Three airflow styles available to fit virtually any engine intake configuration
- Various media available for specific applications — high pulsation and high humidity



## When Selecting an Air Cleaner . . .

Determine the airflow requirements of your engine, then find the corresponding cfm airflow in the table at right. The restriction numbers (shown in inches of water) indicate the approximate initial restriction of each model air cleaner at that cfm. If there are two air cleaner models that fit your parameters, choosing the one with the lower restriction will provide longer filter service life. When calculating total initial restriction of the entire air intake system, include the restriction caused by ducting, elbows, and pre-cleaners. See pages 257-258 for ducting restriction estimates.

### ECB DuraLite

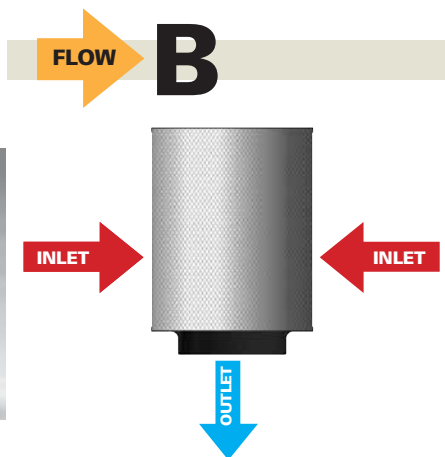

### ECC DuraLite

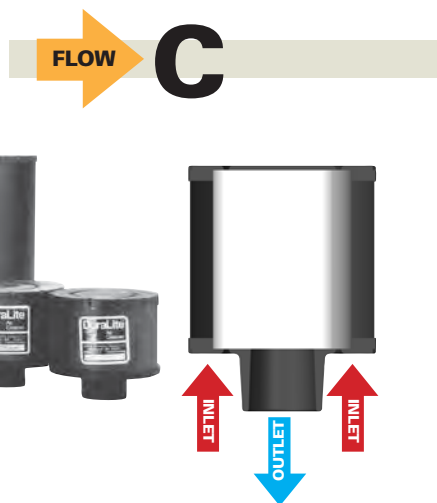

### ECD DuraLite

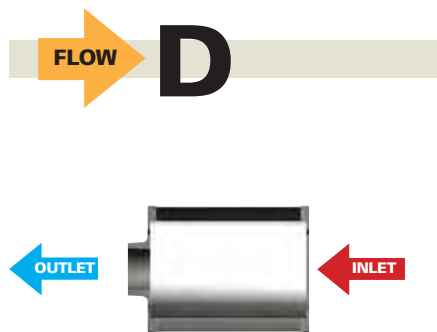

Note: D065008 has inlet holes on both ends of filter

### ECB Initial Airflow Restriction\*

CFM @ "H <sub>2</sub> O			Air Cleaner Model
4"	6"	8"	
175	250	300	B085008
275	335	390	B085001
275	335	390	B085048
280	400	470	B085011
280	400	470	B085046
380	440	480	B105020
400	580	710	B105002
450	590	680	B105006
700	882	1024	B125011
800	1060	1250	B125005
830	1110	1295	B125003
970	1215	1412	B085056
1060	1305	1500	B120439
1550	1836	2118	B120376

### ECC Initial Airflow Restriction\*

CFM @ "H <sub>2</sub> O			Air Cleaner Model
4"	6"	8"	
42	55	64	C045001
55	70	82	C045002
64	82	94	C055003
70	90	106	C055002
95	111	140	C065001
108	137	162	C065002
112	145	170	C085001
115	147	190	C065015
115	150	175	C085005
120	150	175	C065003
130	165	188	C085002
135	170	195	C085006
135	170	195	C085043
150	180	215	C085003
170	205	245	C085004
170	205	245	C085041
325	400	480	C105003
352	400	480	C105028
400	500	620	C105004
400	500	620	C105017
670	830	950	C125004
670	830	950	C125017

### ECD Initial Airflow Restriction\*

CFM @ "H <sub>2</sub> O			Air Cleaner Model
4"	6"	8"	
44	56	65	D045003
50	64	75	D045004
78	97	115	D055004
102	127	152	D065003
125	155	185	D065008

\*Results generated using laboratory testing pursuant to ISO5011. Actual performance during use may vary depending on multiple factors, including specific product configuration, external conditions and application.



### ECB DuraLite™ Specifications

Air Cleaner Models	Body Diameter (A)		Outlet Diameter (C)		Length (D)		Outlet Length (F)		Media Type	Weight	
	in	mm	in	mm	in	mm	in	mm		lbs	kg
B085001	8.50	216	3.00	76	11.00	279	1.38	35	A	4.2	1.9
B085008 <sup>1</sup>	8.75	222	3.00	76	8.50	216	1.38	35	A	5.5	2.5
B085011	8.50	216	4.00	102	11.00	279	1.38	35	A	4.2	1.9
B085046	8.50	216	4.00	102	11.00	279	1.38	35	B	4.2	1.9
B085048	8.50	216	3.00	76	11.00	279	1.38	35	B	4.2	1.9
B085056	7.72	196	5.9	150	11.02	280	1.38	35	B	3.2	1.5
B105002	10.50	267	5.00	127	15.00	381	1.38	35	C	5.9	2.7
B105006	10.50	267	4.00	102	10.50	267	1.38	35	A	5.2	2.4
B105020	10.50	267	4.00	102	10.50	267	1.38	35	B	3.6	1.6
B120376	12.5	318	7.8	198	15.75	400	1.89	48	D	8.0	3.6
B125011	12.5	318	5.0	127	9.0	229	1.38	35	D	6.6	3.0
B120439	12.5	318	7.78	197	15.75	400	1.57	40	A	3.5	1.6
B125003	12.50	318	6.00	152	15.00	381	1.38	35	C	7.1	3.2
B125005	12.50	318	5.50	140	9.00	229	1.38	35	D	5.0	2.3

### ECC DuraLite™ Specifications

Air Cleaner Models	Body Diameter (A)		Outlet Diameter (C)		Length (D)		Outlet Length (F)		Media Type	Weight	
	in	mm	in	mm	in	mm	in	mm		lbs	kg
C045001	4.50	114	1.50	38	4.50	114	1.38	35	C	0.6	0.27
C045002	4.50	114	1.50	38	8.00	203	1.38	35	C	0.9	0.40
C055002	5.50	140	1.75	44	7.00	178	1.38	35	C	1.0	0.45
C055003	5.50	140	1.75	44	4.00	102	1.38	35	C	1.0	0.45
C065001	6.50	165	2.00	51	4.00	102	1.38	35	C	0.8	0.36
C065002	6.50	165	2.00	51	7.50	191	1.38	35	C	1.3	0.60
C065003	6.50	165	2.25	57	5.00	127	1.38	35	C	1.0	0.45
C065015	6.50	165	2.00	51	9.00	229	1.38	35	D	2.0	0.90
C085001	8.50	216	2.50	64	4.00	102	1.38	35	C	1.4	0.64
C085002	8.50	216	2.50	64	6.50	165	1.38	35	C	2.2	1.0
C085003	8.50	216	3.00	76	5.00	127	1.38	35	C	2.2	1.0
C085004	8.50	216	3.00	76	9.50	241	1.38	35	C	3.0	1.4
C085005	8.50	216	2.50	64	5.00	127	1.38	35	C	2.2	1.0
C085006	8.50	216	2.50	64	9.50	241	1.38	35	C	3.0	1.4
C085041 <sup>2</sup>	8.50	216	3.00	76	9.50	241	1.38	35	C	3.0	1.4
C085043 <sup>2</sup>	8.50	216	2.50	64	9.50	241	1.38	35	C	3.0	1.4
C105003	10.50	267	4.00	102	6.00	152	1.38	35	A	2.3	1.0
C105004	10.50	267	4.00	102	10.50	267	1.38	35	A	3.6	1.6
C105017 <sup>2</sup>	10.50	267	4.00	102	10.50	267	1.38	35	A	3.6	1.6
C105028 <sup>2</sup>	10.5	267	4.0	102	6.0	152	1.38	35	A	3.4	1.5
C125004	12.50	318	5.00	127	11.00	279	1.38	35	A	5.8	2.6
C125017 <sup>3</sup>	12.50	318	5.00	127	11.00	279	1.38	35	A	5.8	2.6

### ECD DuraLite™ Specifications

Air Cleaner Models	Body Diameter (A)		Outlet Diameter (C)		Length (D)		Outlet Length (F)		Media Type	Weight	
	in	mm	in	mm	in	mm	in	mm		lbs	kg
D045003	4.50	114	1.50	38	4.50	114	1.38	35	C	0.6	0.27
D045004	4.50	114	1.50	38	6.00	152	1.38	35	C	0.8	0.36
D055004	5.50	140	1.75	44	7.00	178	1.38	35	C	1.0	0.45
D065003	6.50	165	2.00	51	4.00	102	1.38	35	C	0.8	0.36
D065008 <sup>4</sup>	6.50	165	2.00	51	9.00	229	1.38	35	D	1.5	0.68

### Specification Illustrations

#### Specifications Notes:

- 1 - Body is galvanized steel with 4" (254mm) dia. inlet on side
- 2 - Screen inlet deters rodent infestation
- 3 - Has an outer liner on the media pack
- 4 - Has inlet holes at both ends of filter

#### Media Types:

- A = Standard cellulose media  
 B = Treated to withstand higher humidity; most often used in marine applications. Designed for higher airflow/low dust applications ... should NOT be used for normal engine operating environments.  
 C = Reinforced to withstand higher pulsation applications  
 D = Designed for higher airflow/low dust applications ... should NOT be used for normal engine operating environments

### ECB DuraLite

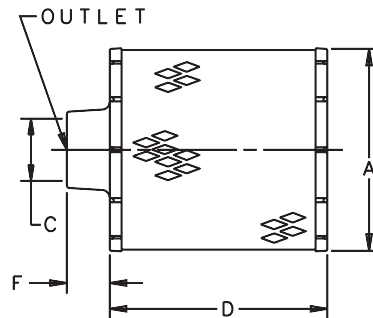

### ECC DuraLite

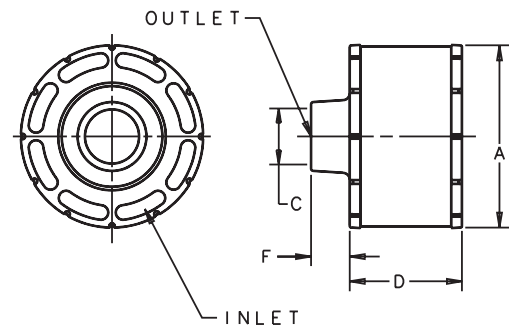

Note: C125017 has an outer liner on the media pack

### ECD DuraLite

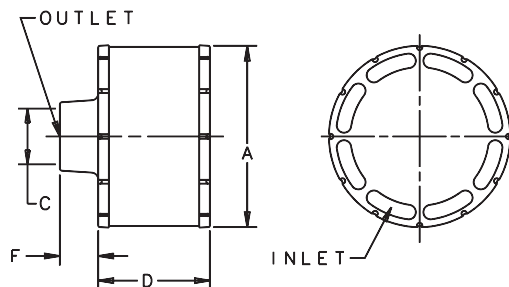

Note: D065008 has inlet holes at both ends of filter



## Installation Instructions

### Installation

DuraLite air cleaners can be mounted in two ways:

1. **Direct Mount:** mounted directly on the intake manifold.
2. **Remote Mount:** mounted away from engine and connected to engine with inlet piping.

### Installation Tips

- Engage outlet neck of the DuraLite over intake piping for a full 1½" to insure a secure, lasting seal.
- Tighten clamp around outlet neck to 60 in•lb minimum. A Donaldson high torque hose clamp is recommended.
- On remote mount style, avoid crushing the body with body clamps. A snug fit is best, and body clamps are not always required.
- Keep away from engine manifold and other very hot components (DuraLite is rated at 180 °F / 83 °C maximum sustained temperature).
- Keep away from battery acids, brake fluid, and other caustic fluids.

#### Direct Mount

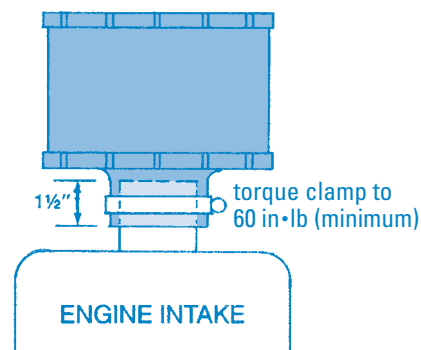

#### Remote Mount

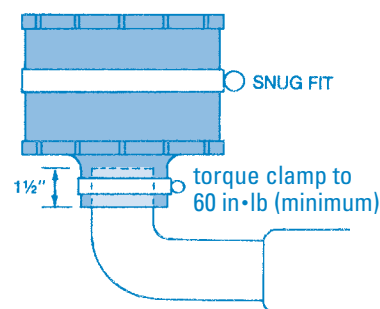

## Service Recommendations

This servicing information is provided as a best practices guide. It is not intended to replace or supersede the service instructions supplied by your engine or vehicle manufacturer.

### Servicing Intervals

Choose either of two types:

- **Scheduled (Miles or Hours).** DuraLite service intervals can be integrated into any existing maintenance program.
- **Filter Service Indicator.** This method offers the most accurate filter maintenance program, delivering maximum filter life, less machine downtime, and reduced maintenance costs.
- Washing, cleaning or servicing the filter in any way voids the warranty.

### Disposal

Follow your local disposal guidelines for disposal.

### Service Indicator Location

For proper restriction readings, a restriction fitting tap must be

located between the engine intake and DuraLite outlet neck. The tap should be located in a straight section of the intake pipe at least one pipe diameter away from the manifold or any bends, elbows or reducers.

### Servicing Tips

- Do NOT judge the filter on the basis of visual inspection! If it's doing its job, it

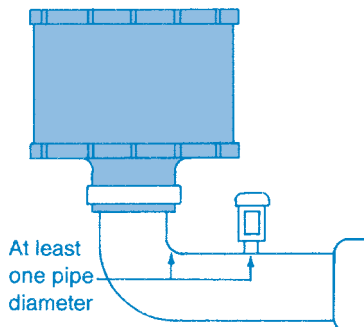

**should** look dirty. DuraLite filter life is longer than you may think. Change the filter only when restriction readings indicate to do so.



During filter change out, do NOT leave the inlet ducting exposed any longer than necessary (a few minutes) during service.

- Never wash or clean the unit for reuse.



# ECO® & ECOLITE® Air Cleaners

- Lightweight
- Sturdy
- One Piece Construction

Use the initial restriction table if your selecting an air cleaner. For a direct replacement to Parker, select the air cleaner style tables.

## Initial Restriction\*

Airflow	Air Cleaner Model
350 cfm @ 8" H <sub>2</sub> O	P537451 ECO-SE
510 cfm @ 8" H <sub>2</sub> O	P537452 ECO-SE
800 cfm @ 8" H <sub>2</sub> O	P613679 ECO-SE
840 cfm @ 8" H <sub>2</sub> O	P537453 ECO-SE
960 cfm @ 8" H <sub>2</sub> O	P537454 ECO-SE
1000 cfm @ 5" H <sub>2</sub> O	P537447 ECOLITE
1000 cfm @ 6" H <sub>2</sub> O	P527586 ECO-CM
1000 cfm @ 7" H <sub>2</sub> O	P524837 ECO-II
1100 cfm @ 6" H <sub>2</sub> O	P537450 ECO-CM
1200 cfm @ 5" H <sub>2</sub> O	P537448 ECOLITE
1200 cfm @ 6" H <sub>2</sub> O	P154927 ECO-II
1230 cfm @ 8" H <sub>2</sub> O	P607373 ECO-SE
1400 cfm @ 7" H <sub>2</sub> O	P524838 ECO-II
1500 cfm @ 5" H <sub>2</sub> O	P537449 ECOLITE
1500 cfm @ 7" H <sub>2</sub> O	P528722 ECO-II
1530 cfm @ 8" H <sub>2</sub> O	P537456 ECO-SM
1550 cfm @ 8" H <sub>2</sub> O	P537455 ECO-SM

\*Results generated using laboratory testing pursuant to ISO5011. Actual performance during use may vary depending on multiple factors, including specific product configuration, external conditions and application.

## When Selecting an Air Cleaner . . .

Determine the airflow requirements of your engine, then find the corresponding cfm airflow in the table at left. The restriction numbers (shown in inches of water) indicate the approximate initial restriction of each model air cleaner at that cfm. If there are two air cleaner models that fit your parameters, choosing the one with the lower restriction will provide longer filter service life. When calculating total initial restriction of the entire air intake system, include the restriction caused by ducting, elbows, and pre-cleaners. See pages 257-258 for ducting restriction estimates.

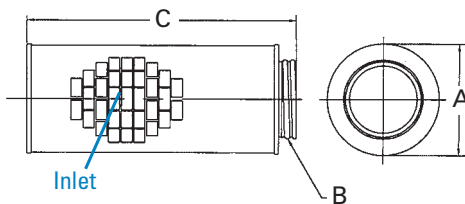
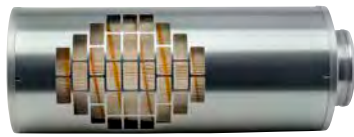

## ECO®-II

Parker Number	Donaldson Number	Body Dia. (A)		Body Length (C)		Inlet Dia.		Outlet Dia. (B) I.D.	
		in	mm	in	mm	in	mm	in	mm
071338001	P524837	9.75	248	24.0	610	Grid	6.0	152	
071338002	P154927	11.0	279	24.0	610	Grid	7.0	178	
071338003	P524838	13.5	343	24.0	610	Grid	7.0	178	
071338004	P528722	13.5	343	18.0	457	Grid	7.0	178	

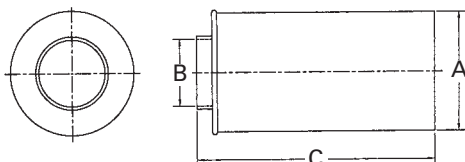

## ECO®-SE

Parker Number	Donaldson Number	Body Dia. (A)		Body Length (C)		Inlet Dia.		Outlet Dia. (B) I.D.	
		in	mm	in	mm	in	mm	in	mm
114500001	P537451	6.75	171	14.2	361	End Perf	3.0	76	
114500002	P537452	7.75	197	17.2	437	End Perf	4.0	102	
114500003	P537453	9.67	246	20.2	513	End Perf	5.0	127	
114880003	P537454	9.70	246	18.1	460	6.0** 152**	5.0	127	
114880005	P613679	7.75	197	17.20	437	6.0** 152**	4.00	102	
400292000	P607373	11.50	292	16.88	429	6.0** 152**	7.00	178	

\*\* side inlet (not illustrated)

ECO and ECOLITE are registered trademarks of Parker-Hannifin Corp., Racor Division





**ECO®-CM**

Parker Number	Donaldson Number	Body Dia. (A)		Body Length (C)		Outlet Dia. (E)		Inlet Dia. (B)		(D)		(F)	
		in	mm	in	mm	in	mm	in	mm	in	mm	in	mm
078897002	P527586	11.0	279	24.0	610	6.0	152	8.0	203	18.5	470	8.9	226
078897001	P537450	13.5	343	24.0	610	7.0	178	8.0	203	5.5	140	11.1	282

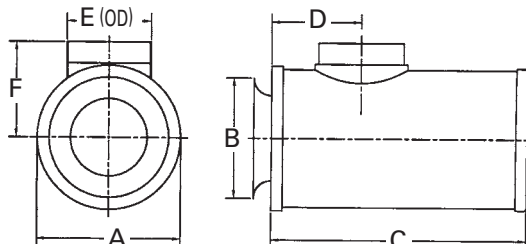
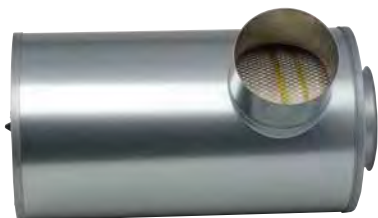

**Competitive Cross Reference**

Baldwin	Donaldson
PA2650.....	P154927
PA2721.....	P537447
PA2722.....	P537448
PA2723.....	P537449
PA2724.....	P524838
PA2731.....	P537450
PA2874.....	P527586
PA2875.....	P528722
PA2876.....	P524837
PA3493.....	P537454
PA3554.....	P537451
PA3555.....	P537452
PA3556.....	P537453

Fleetguard	Donaldson
AH1103.....	P154927
AH1104.....	P537447
AH1105.....	P537448
AH1106.....	P537449
AH1135.....	P524838
AH1135F.....	P524838
AH1183.....	P528722
AH1184.....	P537450
AH1191.....	P537451
AH1192.....	P537452
AH1193.....	P537453
AH1194.....	P524837
AH1197.....	P537454
AH19014.....	P537455
AH19015.....	P537456

**ECOLITE®**

Parker Number	Donaldson Number	Body Dia. (A)		Body Length (C)		Outlet Dia. (E)		Inlet Dia. (B)		(D)		(F)	
		in	mm	in	mm	in	mm	in	mm	in	mm	in	mm
062891001	P537447	9.75	248	24.0	610	6.0	152	6.0	152	5.5	140	6.75	171
062891002	P537448	11.0	279	24.0	610	7.0	178	7.0	178	5.5	140	7.8	198
062891003	P537449	13.5	343	24.0	610	7.0	178	7.0	178	5.5	140	9.1	231

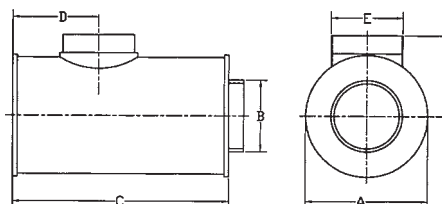

Fram	Donaldson
CA3770.....	P154927
CA6622.....	P524837
CA6623.....	P524838
CA6624.....	P528722
CA6854.....	P537451
CA6855.....	P537453
CA7229.....	P537447
CA7230.....	P537448
CA7231.....	P537449
CA8129.....	P537452
CA8131.....	P537450

Luber-finer	Donaldson
LAF1799.....	P528722
LAF1821.....	P537450
LAF1825.....	P527586
LAF1828.....	P537447
LAF1844.....	P537449
LAF1848.....	P537448
LAF1934.....	P537454
LAF2521.....	P537453
LAF8002.....	P154927
LAF8003.....	P524838

**ECO®-SM**

Parker Number	Donaldson Number	Body Dia. (A)		Body Length (C)		Outlet Dia. (B)		Inlet Dia. (E)		(D)		(F)	
		in	mm	in	mm	in	mm	in	mm	in	mm	in	mm
099842009	P537455	13.5	343	16.8	427	7.0	178	7.0	178	5.5	140	8.6	219
099842010	P537456	13.5	343	16.8	427	7.0	178	7.0	178	9.5	241	8.6	219

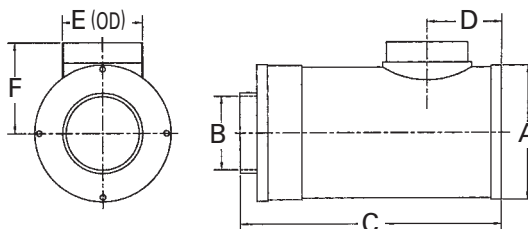

Wix	Donaldson
46743.....	P537451
46748.....	P537454
46755.....	P537453
46759.....	P537452
46848.....	P524837
46849.....	P528722
46850.....	P154927
46851.....	P524838
46857.....	P537455
46858.....	P537456
46891.....	P537447
46893.....	P537448
46895.....	P537449
46897.....	P537450
546755.....	P537453

ECO and ECOLITE are registered trademarks of Parker-Hannifin Corp., Racor Division

# Donaldson's Commitment to Quality & Continuous Improvement

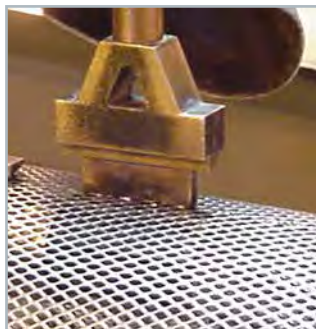

## Donaldson Quality Commitment

Complete Customer Satisfaction,  
Continuous Improvement and  
Problem Prevention in All Activities.

Our process to achieving these goals includes:

- Elimination of waste and variation;
- Setting and maintaining world-class standards and benchmarks.
- Developing and empowering our people; and
- Standardizing processes and measurement of progress.

For the long-term success of our company, understanding their needs and fulfilling customer needs will benefit both our shareholders and our employees. Our management is accountable to ensuring that this policy is understood, implemented and maintained at all levels of our organization.

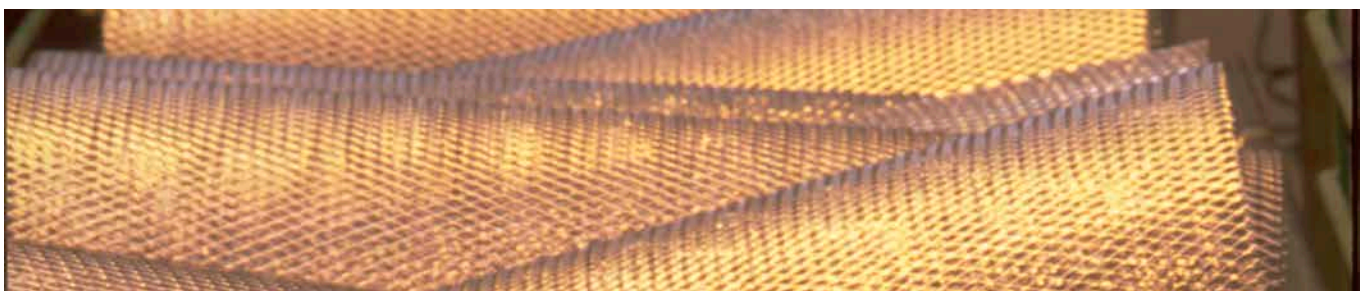



**PowerCore®**  
A Donaldson Filtration Technology

**PowerCore®  
air cleaners deliver . . .**

- System design flexibility
- Metal-free, lightweight materials
- Rugged construction
- Straight-through airflow technology invented by Donaldson
- RadialSeal™ advanced sealing technology



**Section Index  
Section Index**

PSD — Two-Stage..... 30  
PCD — Single-Stage..... 45

This air cleaner family offers high-efficiency filtration in a single, compact unit that delivers superior performance using our PowerCore® Filtration Technology.

**PSD Family**

Designed for medium to heavy dust conditions, the PSD air cleaner has a built in inertial particle separator that can remove up to 96% of incoming contaminant. PSD air cleaners are also adaptable to a scavenged air system.

**PCD Family**

The PCD air cleaner family is better suited for light dust conditions since it does not have a built-in pre-cleaner like the PSD. It can, however, be connected to an external pre-cleaner.

**PowerCore® Straight-Through Airflow Schematic**

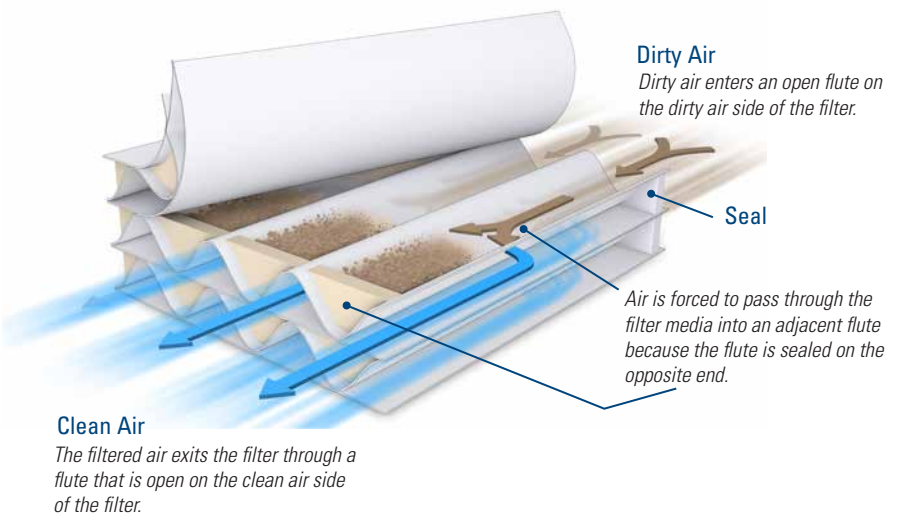

**Big Performance, Small Footprint**

**PowerCore air filters are up to 65% smaller than a conventional RadialSeal™ filter.**



## Millions of PowerCore® Filters Installed on Original Equipment

This air cleaner family offers two-stage filtration in a single, compact unit that delivers superior filtration performance using our PowerCore® Filtration Technology.

This non-metal air cleaner (except for cover clamps) is ideal for equipment operating in medium to heavy dust environments.

### Applications

- Off-road equipment operating in medium to heavy dust conditions with engine airflow ranges up to 1252 cfm
- Scavenged system components — exhaust ejectors and check valves — now available. See page 39–38 for more details.
- Obround housing shape allows for a narrow or wide mounting orientation.
- Models have either end or side filter service access
- Sustained temperature tolerance: -40 °F to 180 °F / -40 °C to 82 °C

### Features

- More compact at a given performance level than standard pleated filters
- Non-metal filters
- Improved engine protection: no media movement, expansion, contraction or bunching
- Improved contaminant encapsulation: dust and dirt stay contained in filter during service
- High efficiency integrated pre-cleaner improves filter life
- Improved handling and maintenance: lighter and smaller, changing filters is a snap
- Easily serviced; no tools required to remove or replace cover
- Can be used with scavenge line or Vacuator™ Valve
- Built-in mounting brackets eliminate the need to purchase separate mounting bands

### Service Access on Inlet End — PSD08

*Exploded view of D080020*

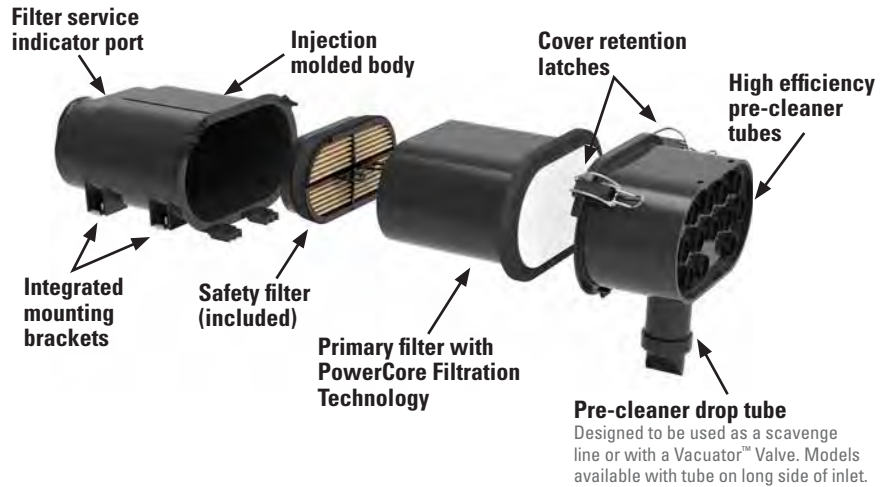

### Service Access on Side — PSD08, PSD09, PSD10, PSD12 and PSD14

*Exploded view of D090073*

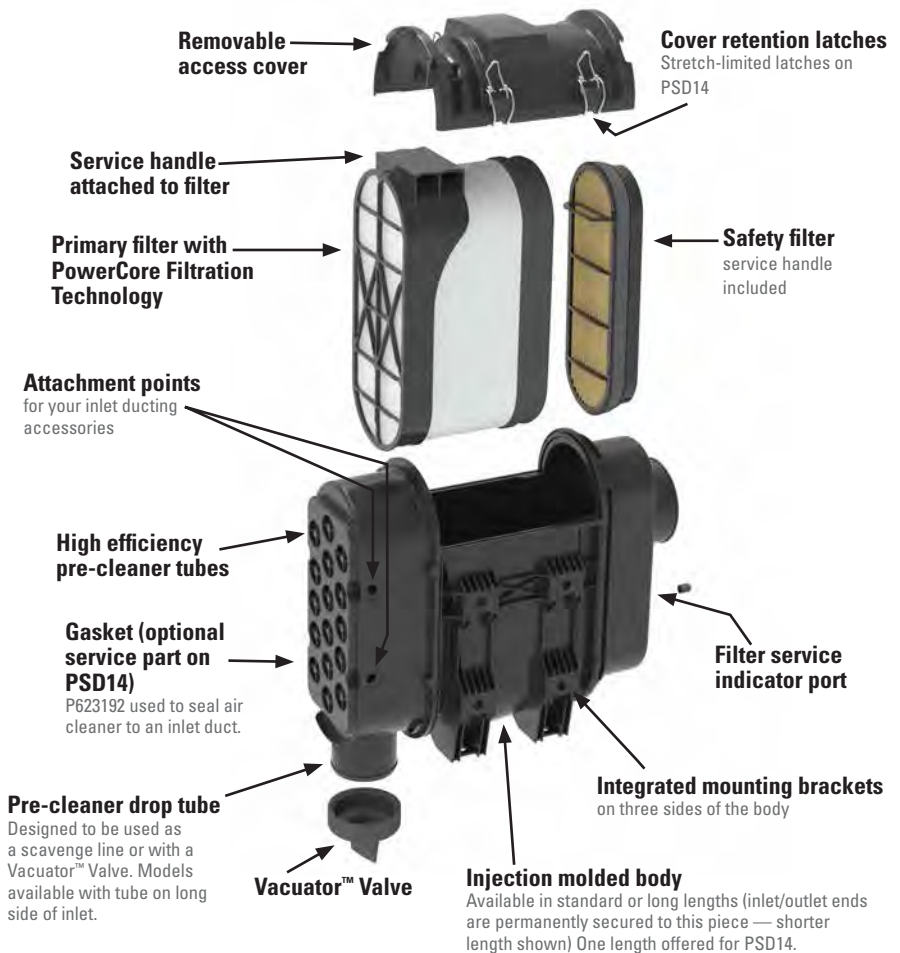





**When Selecting an Air Cleaner . . .**

Determine the airflow requirements of your engine, then find the corresponding cfm airflow in the table below. The restriction numbers (shown in inches of water) indicate the approximate initial restriction of each model air cleaner at that cfm. If there are two air cleaner models that fit your parameters, choosing the one with the lower restriction will provide longer filter service life. When calculating total initial restriction of the entire air intake system, include the restriction caused by ducting, elbows, and pre-cleaners. See pages 257-258 for ducting restriction estimates.

**PSD Air Cleaners and Scavenge Air Systems**

PSD air cleaners are designed to operate with or without aspiration, otherwise known as scavenging. PSD performance charts include scavenged performance data. It is recommended to use a scavenge system for horizontally mounted PSD12 and PSD14 applications. For more information on scavenging, refer to page 37.

**PSD Air Cleaner Performance Curves\***

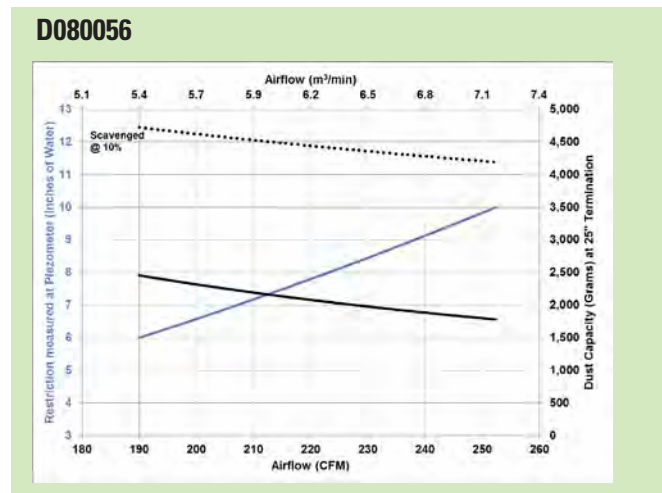
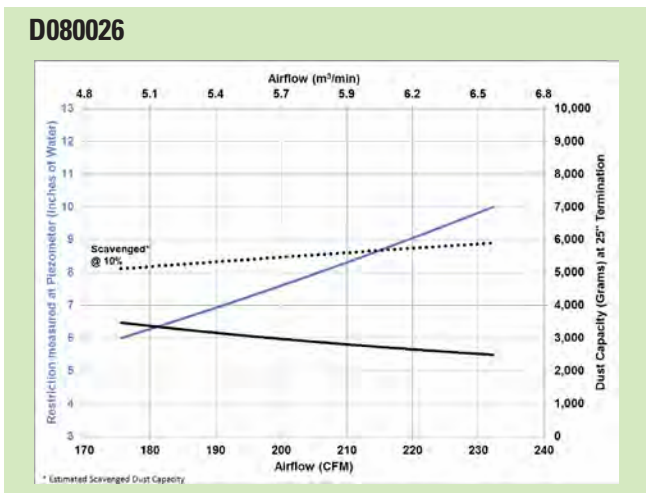
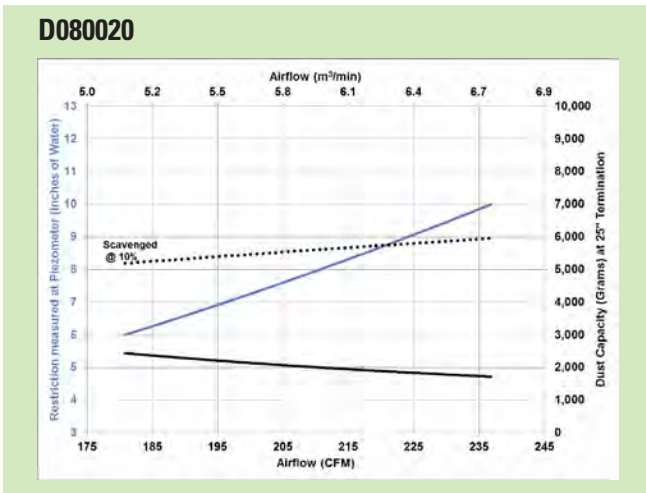

**Initial Airflow Restriction (non-scavenged)**

6"	CFM @ "H <sub>2</sub> O		Air Cleaner Model
	8"	10"	
<b>MODELS WITH SERVICE ACCESS ON END</b>			
176	206	232	D080026
181	211	237	D080020
<b>MODELS WITH SERVICE ACCESS ON SIDE</b>			
190	223	252	D080056
284	332	374	D090121
291	339	382	D090073
291	338	380	D090101
311	359	401	D090055
311	359	401	D090120
460	539	609	D100029
512	597	672	D100030
512	597	672	D100072
534	622	700	D100031
539	629	708	D100032
539	629	708	D100068
629	737	832	D120037
648	755	849	D120035
682	795	895	D120038
687	800	899	D120036
951	1111	1252	D140111
955	1110	1246	D140110

\*Results generated using laboratory testing pursuant to ISO5011. Actual performance during use may vary depending on multiple factors, including specific product configuration, external conditions and application.





continued — PSD Air Cleaner Performance Curves

**D090073**

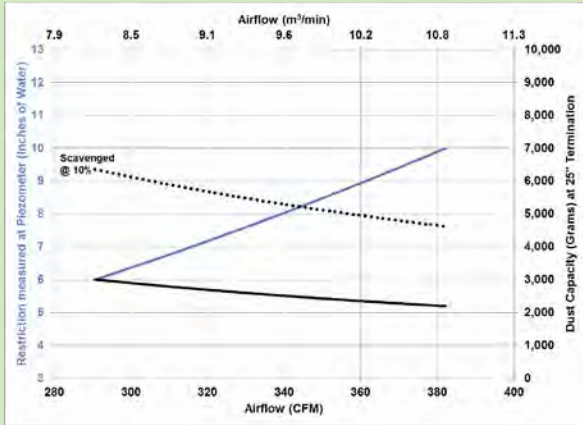

**D090055, D090120**

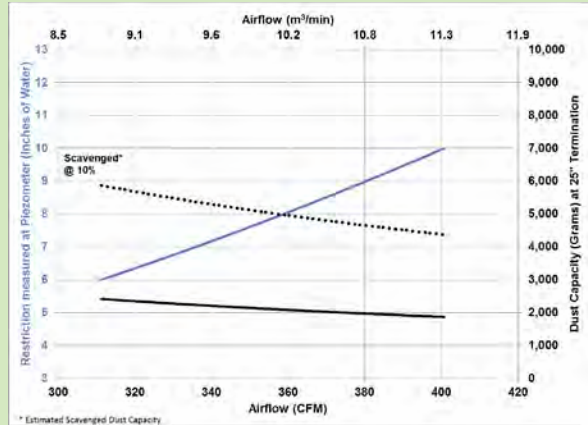

**D090101**

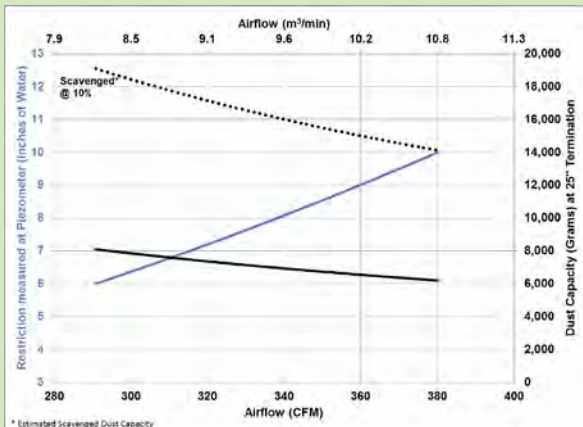

**D090121**

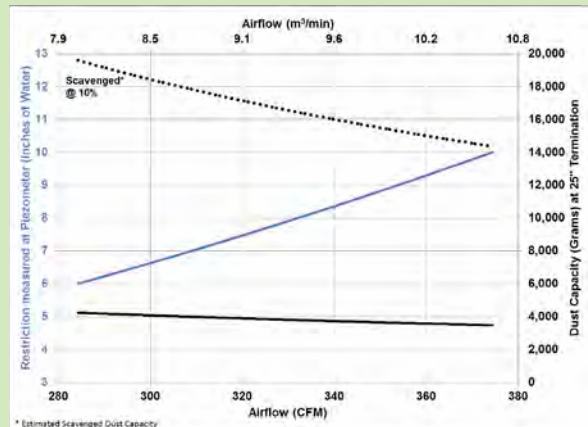

**D100029**

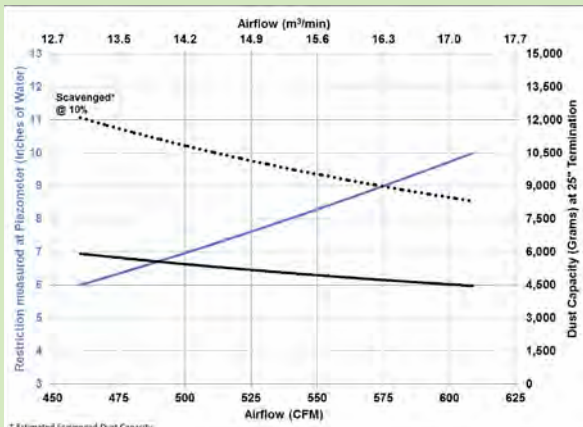

**D100030, D100072**

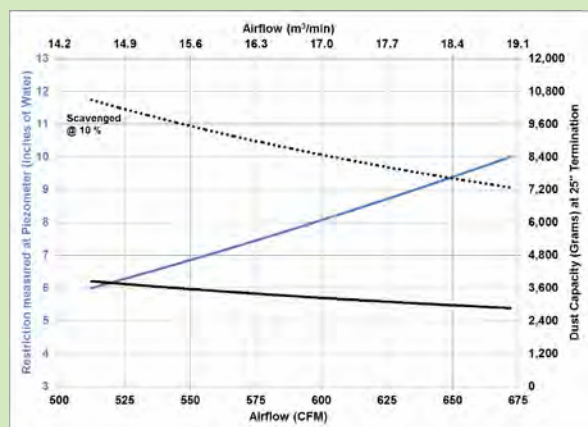

continued – PSD Air Cleaner Performance Curves

**D100032, D100068**

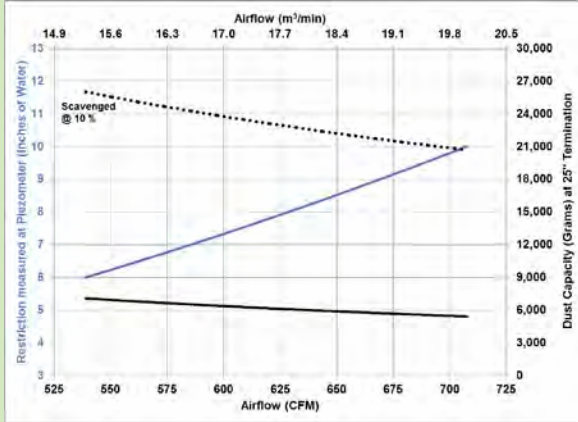

**D100031**

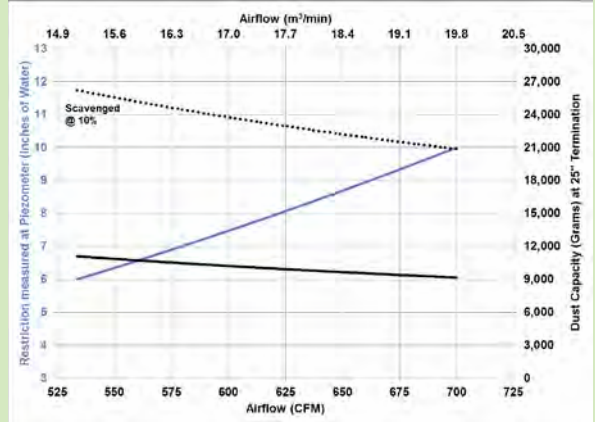

**D120035**

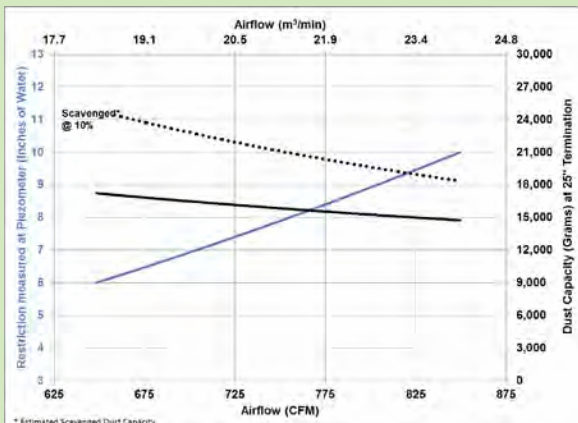

**D120036**

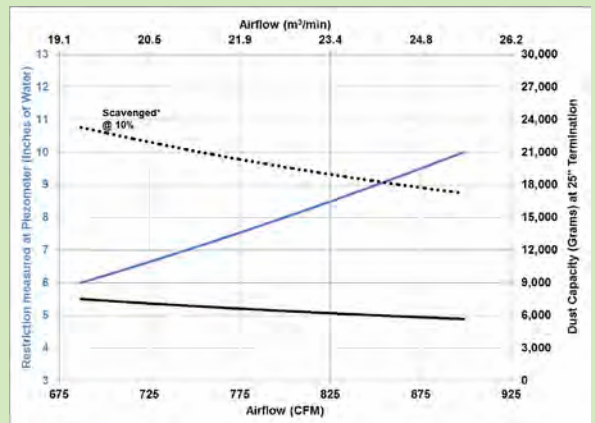

**D120037**

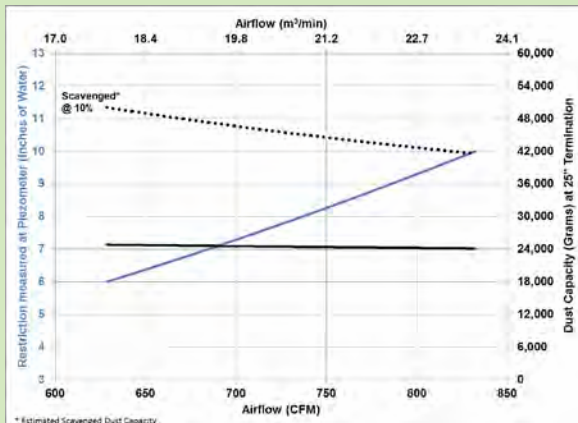

**D120038**

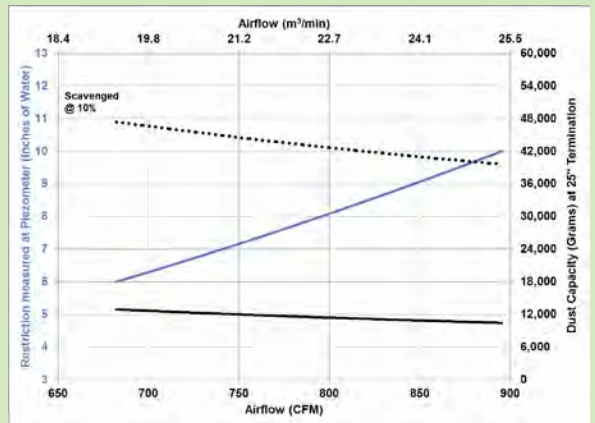



## continued — PSD Air Cleaner Performance Curves

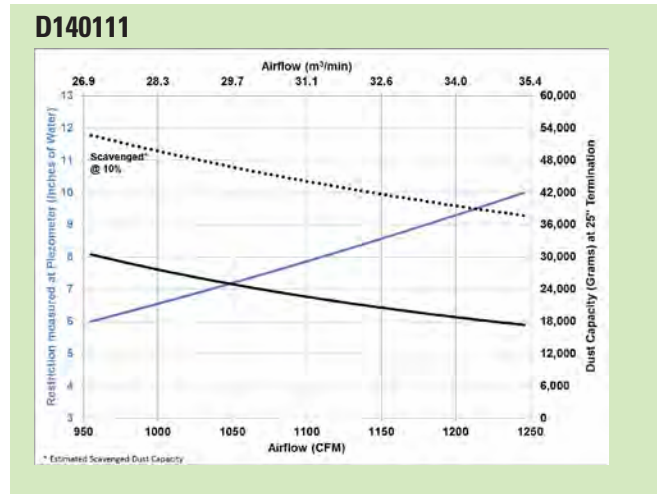
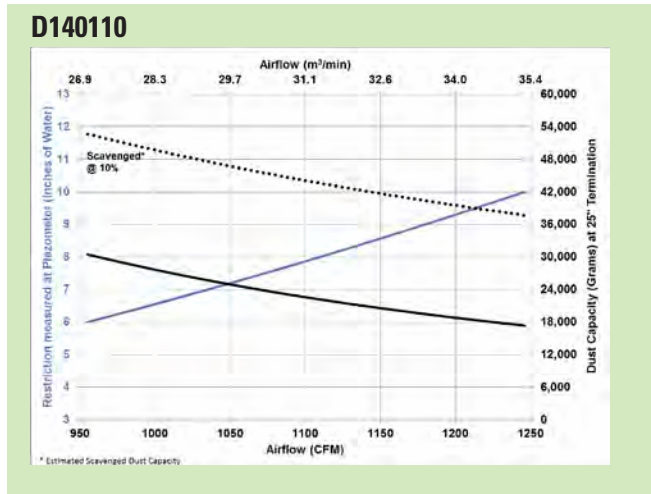

## PSD Specification Illustrations

### PSD08 Models — Service Access on End (Vertical Model Shown)

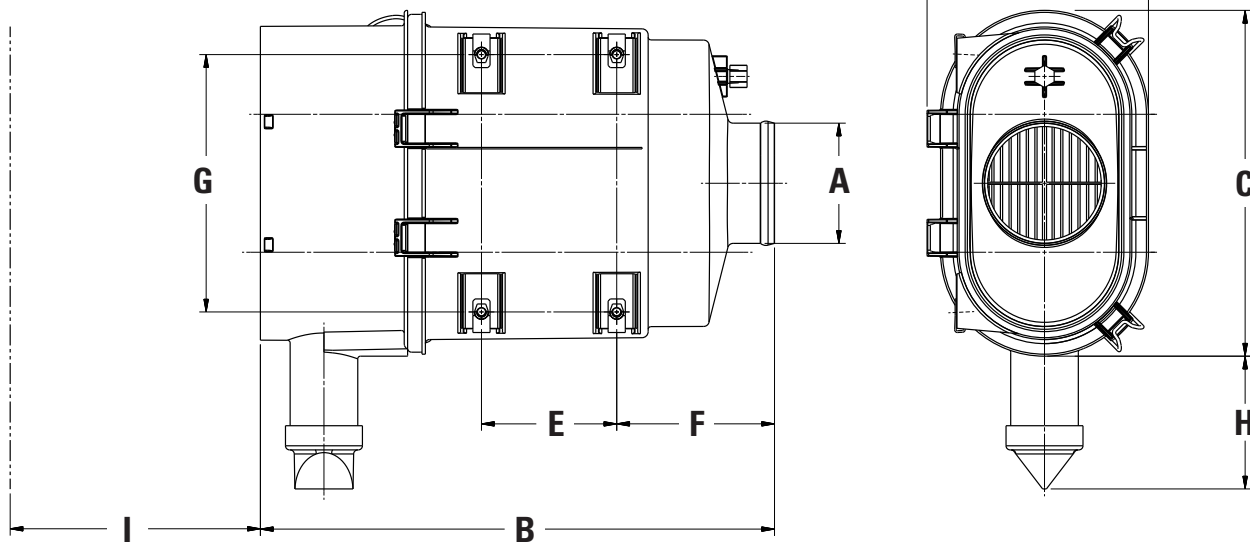

**Note:** a minimum service clearance of 50mm (2.00") is required for wire latches.



D080020 — Horizontal



D080026 — Vertical

## PSD Specifications (Letters are keyed to drawings)

Orientation: H=Horizontal; V=Vertical

Part No. / Orientation	A mm/in	B mm/in	C mm/in	D mm/in	E mm/in	F mm/in	G mm/in	H mm/in	Service Clearance (I) mm/in	Weight kg/lbs
<b>MODELS WITH SERVICE ACCESS ON END</b>										
D080020 H	89/3.50	380/14.97	256/10.07	154/6.05	100/3.94	117/4.59	191/7.50	98/3.87	80/3.2	4.8/10.5
D080026 V	102/4.00	553/21.77	365/14.37	180/7.09	180/7.09	183/7.21	100/3.94	130/5.12	80/3.2	4.8/10.5

PSD08, PSD09, PSD10, PSD12 — Service Access on Side (Vertical Model Shown)

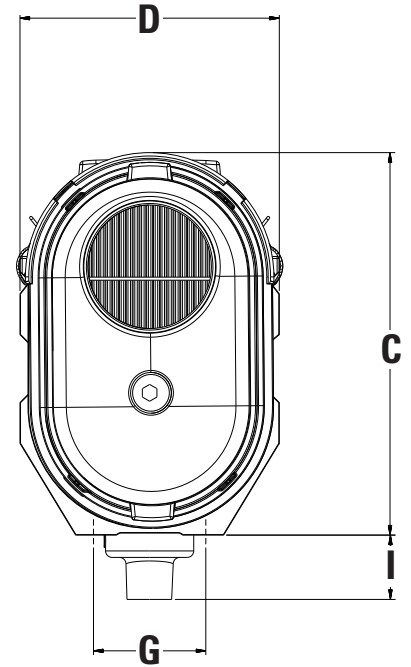
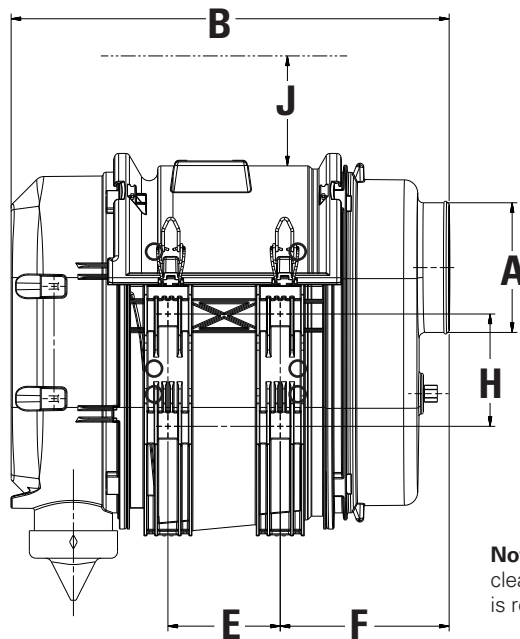

**Note:** a minimum service clearance of 50mm (2.00") is required for wire latches.



D080056 — Vertical



D090120 — Horizontal



D100029 — Vertical

**PSD Specifications** (Letters are keyed to drawings)

Orientation: H=Horizontal; V=Vertical

Part No. / Orientation	A mm/in	B mm/in	C mm/in	D mm/in	E mm/in	F mm/in	G mm/in	H mm/in	I mm/in	Service Clearance (J) mm/in	Weight kg/lbs
<b>MODELS WITH SERVICE ACCESS ON SIDE</b>											
D080056 V	89/3.50	370/14.55	247/9.70	180/7.09	69/2.72	142/5.60	118/4.65	75/2.95	51.9/2.04	240/9.5	2.2/4.9
D090073 V	102/4.00	433/17.05	362/14.25	180/7.09	110/4.33	174/6.85	100/3.94	130/5.12	72/2.85	356/14.0	3.7/8.1
D090101 V	102/4.00	533/20.98	363/14.29	180/7.09	180/0.09	183/7.21	100/3.94	130/5.12	70/2.75	356/14.0	4.3/9.5
D090120 H*	102/4.00	433/17.05	360/14.17	180/7.09	110/4.33	174/6.85	110/4.32	130/5.12	60/2.36	356/14.0	3.7/8.1
D090121 H	102/4.00	533/20.98	363/14.29	180/7.09	180/7.09	183/7.21	110/4.32	130/5.12	60/2.36	356/14.0	4.3/9.5
D090055 H*	102/4.00	432/17.00	363/14.31	180/7.09	110/4.33	173/6.83	100/3.94	130/5.12	68/2.68	330/13.0	5.0/11.0
D100029 V	127/5.00	429/16.90	374/14.74	254/10.01	110/4.33	165/6.50	110/4.33	110/4.33	63/2.48	356/14.0	5.3/11.7
D100030 H**	127/5.00	429/16.90	374/14.74	254/10.01	110/4.33	165/6.50	110/4.33	110/4.33	70/2.76	356/14.0	5.3/11.7
D100031 V	152/6.00	529/20.84	384/15.12	254/10.01	210/8.27	165/6.50	110/4.33	110/4.33	54/2.12	356/14.0	6.1/13.4
D100032 H***	152/6.00	529/20.84	384/15.12	254/10.01	210/8.27	165/6.50	110/4.33	110/4.33	70/2.76	356/14.0	6.1/13.4
D100068 H***	152/6.00	529/20.84	384/15.12	254/10.01	210/8.27	165/6.50	110/4.33	110/4.33	70/2.76	356/14.0	6.1/13.4
D100072 H**	127/5.00	429/16.90	374/14.74	254/10.01	110/4.33	165/6.50	110/4.33	110/4.33	70/2.76	356/14.0	5.3/11.7
D120035 V	152/6.00	496/19.53	430/16.93	306/12.04	168/6.62	160/6.30	154/6.08	110/4.33	68/2.68	405/16.0	7.0/15.5
D120036 H	152/6.00	496/19.53	430/16.93	306/12.04	168/6.62	160/6.30	154/6.08	110/4.33	68/2.68	405/16.0	7.0/15.5
D120037 V	152/6.00	596/23.46	441/17.36	306/12.04	268/10.56	160/6.30	154/6.08	110/4.33	68/2.68	405/16.0	7.9/17.4
D120038 H	152/6.00	596/23.46	441/17.36	306/12.04	268/10.56	160/6.30	154/6.08	110/4.33	68/2.68	405/16.0	7.9/17.4

\* D090120 access cover is positioned 180° compared to the access cover location on the D090055.

\*\* D100030 access cover and outlet tube are positioned 180° compared to access cover and outlet tube locations on the D100072.

\*\*\* D100032 access cover and outlet tube are positioned 180° compared to access cover and outlet tube locations on the D100068.



PSD14 — Service Access on Side (Vertical Model Shown)

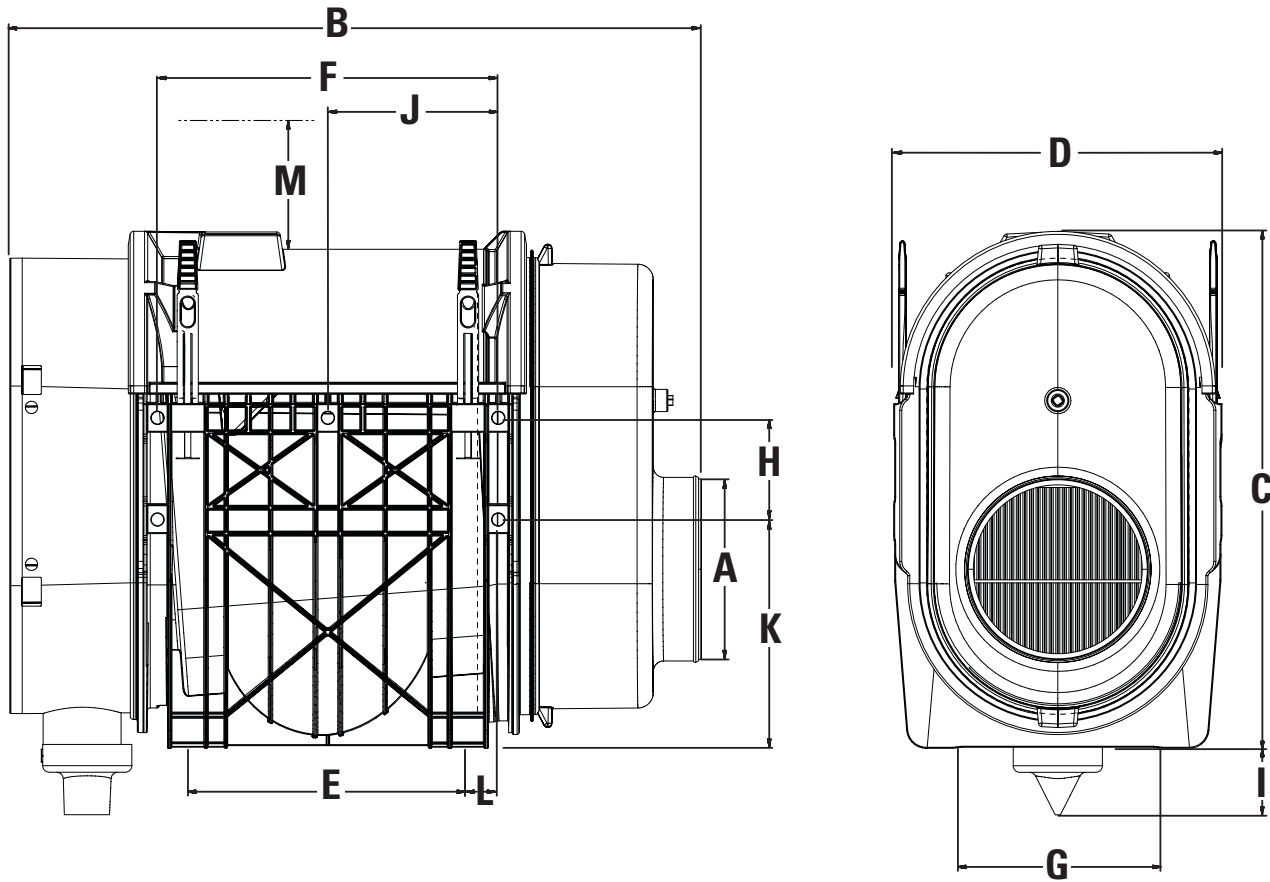

The PSD14 air cleaner MUST be mounted with nine U-clips — four on the side opposite the access cover and all five U-Clips on ONE of the two sides.



### PSD14 Specifications (Letters are keyed to drawings)

Orientation: H=Horizontal; V=Vertical

Part No. / Orientation	A	B	C	D	E	F	G	H	I	J	K	L	Service Clearance (M)	Weight
	mm/in	mm/in	mm/in	mm/in	mm/in	mm/in	mm/in	mm/in	mm/in	mm/in	mm/in	mm/in	mm/in	kg/lbs
<b>MODELS WITH SERVICE ACCESS ON SIDE</b>														
D140110 V	178/7.00	670/26.37	501/19.71	318/12.52	272/10.68	330/13.0	230/9.00	98/3.87	65/2.53	165/6.5	222/8.75	29/1.2	460/18.1	11.4/25.0
D140111 H	178/7.00	670/26.37	501/19.71	318/12.52	272/10.68	330/13.0	230/9.00	98/3.87	66/2.60	165/6.5	222/8.75	29/1.2	460/18.1	11.4/25.0



### Scavenge System Components

Scavenging, also known as aspirating, is accomplished by introducing a secondary airflow to the drop tube on the air cleaner — generally through the use of an ejector or ejector muffler (see illustration on right). This flow pulls the separated contaminant from the pre-cleaner and inserts it into the exhaust stream.

- The advantages to scavenging are:
- Higher pre-cleaner efficiency (resulting in longer filter service life)
  - Completely self-servicing (no regular maintenance needed on pre-cleaner)

Exhaust ejectors, adapters (below), and check valves (next page) complement the PSD air cleaner product offering.

Illustration of Scavenge Connection with PSD10 Horizontal Model

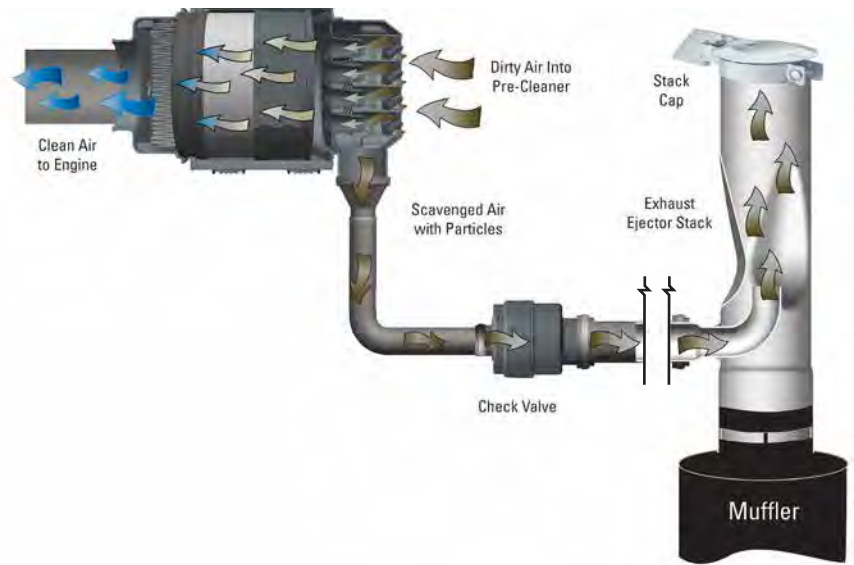

### Exhaust Ejectors

All exhaust ejectors are constructed of heavy-gauge, aluminized steel and painted with high-temperature black paint. Select the appropriate ejector by the intake airflow or exhaust flow (CFM) of your engine. These same parts and more information on ejectors can be found in the accessories section of this product guide.

Engine Intake CFM		Exhaust CFM @ 900 °F		Standard Ejectors Inlet Dia.*		Part Number	Expanded I.D. Ejectors Inlet Dia.*		Part Number	Length		Scavenge Tube O.D.	
Low	High	Low	High	inches	mm		inches	mm		inches	mm	inches	mm
220	365	554	919	3.02	77.0	H002612	3.16	80.3	H002762	12.00	304.8	1.25	32
315	450	793	1133	4.02	102.0	H002613	4.17	105.9	H002763	18.00	457.2	1.25	32
425	600	1070	1511	4.02	102.0	H002614	4.17	105.9	H002764	18.00	457.2	1.50	38
500	740	1259	1864	5.03	127.8	H002615	5.17	131.0	H002765	22.00	558.8	1.50	38
660	950	1662	2393	5.03	127.8	H002616	5.17	131.0	H002766	22.00	558.8	1.75	44
800	1150	2015	2896	6.04	153.4	H002617	6.19	157.0	H002767	24.00	609.6	2.00	51
950	1350	2393	3400	6.04	153.4	H002618	6.19	157.0	H002768	24.00	609.6	2.00	51
1100	1500	2770	3778	6.04	153.4	H002619	6.19	157.0	H002769	24.00	609.6	2.00	51

### Scavenge Adapters



Straight Adapter



90° Adapter

Part Number	Adapter Type	Outlet Dia.		Diameter		Height	
		inches	mm	inches	mm	inches	mm
P783746	3" TO 1.50" STRAIGHT	1.50	38	3.00	78	2.68	68
P783747	3" TO 1.25" STRAIGHT	1.25	32	3.00	78	2.68	68
P783748	3" TO 2.00" STRAIGHT	2.00	50	3.00	78	2.68	68
P784019	3" TO 1.25" 90 DEGREE	1.25	32	3.00	78	2.68	68
P617276	3" TO 2.00" 90 DEGREE	2.00	50	3.00	78	2.20	56



## Check Valve Operation and Orientation

- Prevents back flow of exhaust gas into pre-cleaner
- For proper installation, it is important that the index is installed upward and horizontal with no more than a 20° variation. See below.
- Install inline check valve as close as possible to the air cleaner
- Temperature resistance of 200 °C / 400 °F

Part Number	Inlet Dia.		Outlet Dia.		Length		Body Dia.	
	inches	mm	inches	mm	inches	mm	inches	mm
P786337	1.25	32	1.25	32	4.45	113	2.80	71
P786340	1.50	38	1.50	38	4.45	113	2.80	71
P786343	2.00	50	2.00	50	4.45	113	2.80	71

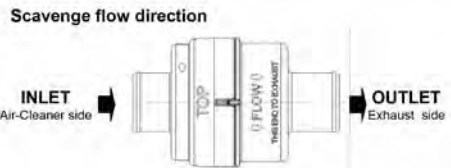
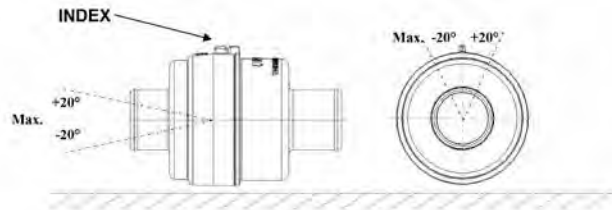

## Mounting Flexibility

With mounting locations on three sides of the housing (exception D080020 & D080026) and two separate drop tube orientations, the PSD series offers the greatest amount of flexibility for a wide variety of installations.



U-clips are shipped with each air cleaner. Affix these to the mounting location (all in the same direction) and slide the housing into place. See dimensional illustration for u-clip mounting hole pattern on pages 35 and 36.

side. It should not be mounted using the two side mounting locations — as this will cause pressure/flexing, and could result in leaks. (See illustration, on right. Xs represent u-clips mounted on both sides adjacent to the access cover.) The u-clips accept M8 threaded fasteners. Maximum torque is 18 N•m.

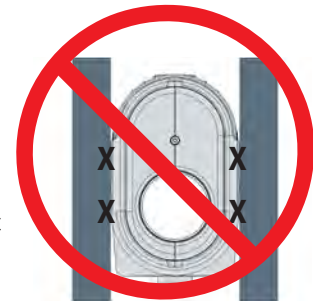

The PSD air cleaner needs to be mounted to equipment on at least one mounting location (base, or either of two sides). It can also be mounted at two points, using the base and one

The PSD14 air cleaner MUST be mounted with nine U-clips — four on the side opposite the access cover and all five U-Clips on ONE of the two sides.

## Mounting Orientation Guidelines

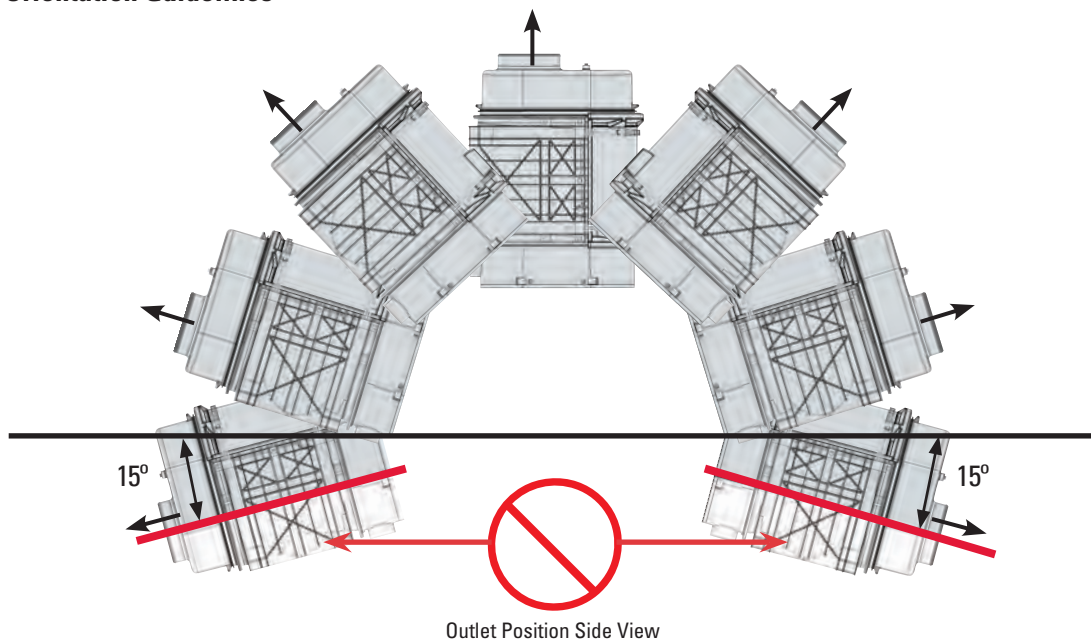

### CAUTION: Outlet Tube Mounting Position

The outlet tube angled 15° below the horizontal axis could allow dust or foreign objects to fall into the air duct or engine during servicing.

**Scavenged System Mounting** (shaded air cleaners indicate proper mounting positions; indicates scavenge line direction)

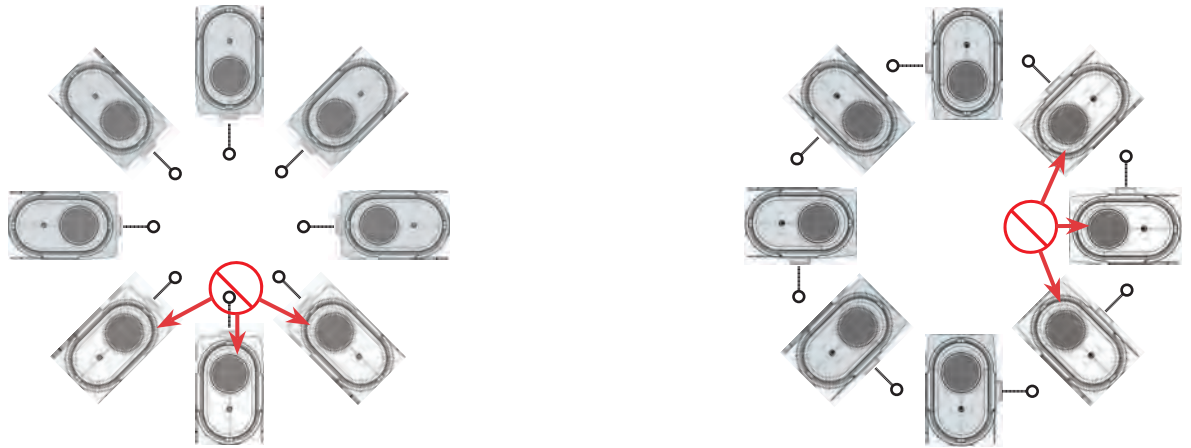

**Non-Scavenged System Mounting with Vacuator™ Valve** (shaded air cleaners indicate proper mounting positions)

Vertical PSD enlarged to show Vacuator™ Valve detail.



Horizontal PSD enlarged to show Vacuator™ Valve detail.

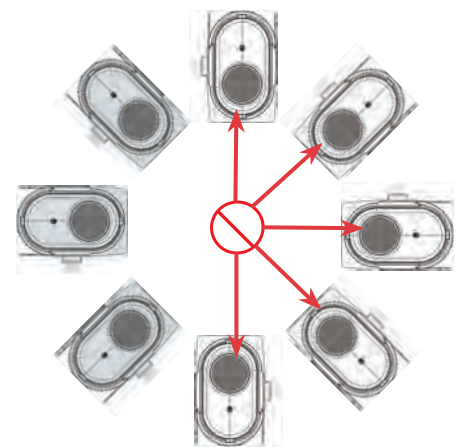
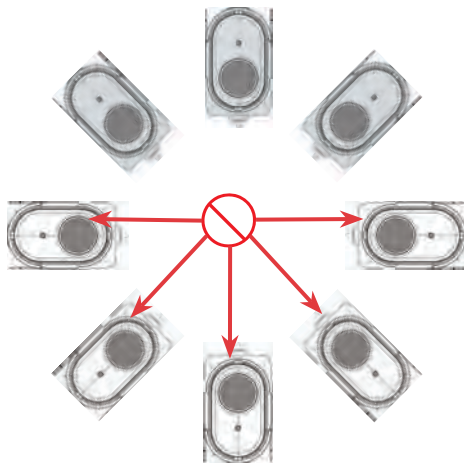
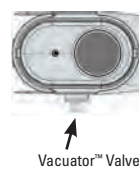

A PSD10 mounted horizontally was the equipment manufacturer's choice on this diesel-powered (285 HP @ 2,000 RPM) feller buncher.





This servicing information is provided as a best practices guide. It is not intended to replace or supersede the service instructions supplied by your engine or vehicle manufacturer. Note: Your air cleaner service cover may be in a different position than shown.

## 1 Check the Restriction

Replace the filter only when the restriction level has reached the maximum recommended by the engine or equipment manufacturer or on a regular scheduled service.



## 2 Check Vacuator™ Valve & Pre-Cleaner Tubes

Shut off the engine. Inspect the Vacuator™ Valve (or scavenge line) for damage. If damaged, replace. If plugged or full of contaminant, check the pre-cleaner tubes, which should be free of contaminant. If plugged or excess contaminant is visible, the pre-cleaner tubes will need to be cleaned.

To clean the pre-cleaner tubes, remove the housing service cover and Vacuator Valve and leave the filter installed (to avoid dust from entering the air induction outlet). Use a low-volume of compressed air to gently blow out the separator tubes. The compressed air can be pushed through both sides of the tubes AND from the drop tube where the Vacuator Valve attaches.

If compressed air is not available or the use of compressed air was not effective due to dried contaminant within the housing, remove the air cleaner from the machine, cover the air intake pipe to prevent contaminant. Remove the primary and secondary filters and Vacuator Valve. Use a low pressure water (e.g., garden hose) to clean the tubes and inside of housing. Direct the flow of water through the separator tubes from both ends and repeat as needed to clean out the housing. Spray out the Vacuator Valve port, alternating between it and the separator tubes. Make sure that all internal housing surfaces are dry prior to reinstalling the filters, Vacuator Valve, and unit on the machine.



*NEVER use a pressure sprayer to clean out the air cleaner housing while it is installed on the machine. Avoid using excessive pressure when spraying out the separator tubes as damage can occur.*

## 3 Remove the Primary Filter

For end service pull the filter out of the housing.

For side service push down on the service handle to tilt the filter to a 5° angle. This will loosen the seal. Then, pull up on the service handle to remove the filter from the housing.



## 4 Visually Inspect the Safety Filter

Remove any excess dirt and wipe out the housing with a damp cloth before servicing the safety filter. Visually inspect the safety filter but do not remove it unless it is damaged or due for change-out. Verify that the safety filter is properly seated in the housing. The safety filter should be replaced every three primary filter changes.



*The safety filter should be replaced every three primary filter changes.*

## 5 Remove Safety Filter if Indicated or if Excessively Contaminated

To remove the safety filter, use the plastic handle on the face of the safety filter. Pull the filter toward the center of the housing and remove it. Ensure that the outlet tube sealing area is clean and undamaged. If the safety filter is removed and the new filter is not to be installed immediately, be sure to cover the seal tube with a cloth so that dirt is not admitted. After removing the safety filter, wipe the air cleaner housing interior and seal surfaces with a clean, damp cloth.





## 6 Inspect the New Filters

Visually check for cuts, tears or indentations on the sealing surfaces and the media pack before installation. If any damage is visible, do not install.



## 7 Replace the Safety Filter

If replacing the safety filter, use the plastic handle. Slide the filter at an angle into the outlet side and push it in place until the filter seats firmly and evenly within the housing.

On side-service access models, insert the safety filter tab into the positioning slot before pushing the filter into place.



## 8 Insert the Primary Filter

For end service access models, slide the primary filter into the housing until the gasket seats against the housing. For side service access models, slide the filter down at approximately a 5° angle until it makes contact with the end of the housing. Rotate the filter toward the outlet section to complete the seal.



## 9 Replace the Service Cover

For end service access models with hinge tabs, insert the hinge tabs into the housing, tilt the service cover into place and secure latches. For end service models without hinge tabs, put the service cover into place and secure the latches. For side-service access models, place the service cover in position and fasten the metal or rubber (PSD14) latches. If the cover doesn't seat, remove and re-check the filter position and access cover orientation.



## 10 Inspect the Entire Air Cleaner System

Make sure that inlet and outlet connections are in good condition. Torque to and do not exceed 40 in·lb. Replace rubber connectors if necessary and reset the service indicator.







## Service Parts & Accessories

D080020, D080026	PSD
Cover (D080020).....	P602985 ...3
Cover (D080026).....	P601735 ...3
Elbow, 45°.....	P109331
Elbow, 90°.....	P114318
Filter, primary.....	P608533 ...3
Filter, safety.....	P600975 ...3
Hump hose.....	P114319
Informer™ indicator 25" H <sub>2</sub> O.....	X002277
Latch.....	P776033 ...3
Outlet band clamp.....	P148342
Vacuator™ Valve.....	P158914 ...3

D080056	PSD
Cover.....	P615530 ...3
Elbow, 45°.....	P109331
Elbow, 90°.....	P114318
Filter, primary.....	P617631 ...3
Filter, safety.....	P615493 ...3
Hump hose.....	P114319
Informer™ indicator 25" H <sub>2</sub> O.....	X002277
Latch.....	P776033 ...3
Outlet band clamp.....	P148342
U-clip (4 clips).....	P784517 ...3
Vacuator™ Valve.....	P617632 ...3

D090055, D090073	PSD
Cover.....	P785651 ...3
Elbow, 45°.....	P105545
Elbow, 90°.....	P105533
Elbow, 90° reducing.....	P121482
Filter, primary.....	P608665 ...3
Filter, safety.....	P606121 ...3
Hump hose.....	P105609
Informer™ indicator 25" H <sub>2</sub> O.....	X002277
Latch.....	P777366 ...3
Outlet band clamp.....	P148343
U-clip (4 clips).....	P784517 ...3
Vacuator™ Valve.....	P112803 ...3

D090101	PSD
Cover.....	P786989 ...3
Elbow, 45°.....	P105545
Elbow, 90°.....	P105533
Elbow, 90° reducing.....	P121482
Filter, primary.....	P608675 ...3
Filter, safety.....	P606121 ...3
Hump hose.....	P105609
Informer™ indicator 25" H <sub>2</sub> O.....	X002277
Latch.....	P777366 ...3
Outlet band clamp.....	P148343
U-clip (4 clips).....	P784517 ...3
Vacuator™ Valve.....	P112803 ...3

D090120	PSD
Cover.....	P785651 ...3
Elbow, 45°.....	P105545
Elbow, 90°.....	P105533
Elbow, 90° reducing.....	P121482
Filter, primary.....	P608665 ...3
Filter, safety.....	P606121 ...3
Hump hose.....	P105609
Informer™ indicator 25" H <sub>2</sub> O.....	X002277
Latch.....	P777366 ...3
Outlet band clamp.....	P148343
U-clip (4 clips).....	P784517 ...3
Vacuator™ Valve.....	P112803 ...3

D090121	PSD
Cover.....	P786989 ...3
Elbow, 45°.....	P105545
Elbow, 90°.....	P105533
Elbow, 90° reducing.....	P121482
Filter, primary.....	P608675 ...3
Filter, safety.....	P606121 ...3
Hump hose.....	P105609
Informer™ indicator 25" H <sub>2</sub> O.....	X002277
Latch.....	P777366 ...3
Outlet band clamp.....	P148343
U-clip (4 clips).....	P784517 ...3
Vacuator™ Valve.....	P112803 ...3

D100029, D100030, D100072	PSD
Cover.....	P784279 ...3
Cover, with watertight seal.....	P619481
Elbow, 45°.....	P109021
Elbow, 90°.....	P107844
Elbow, 90° reducing.....	P143895
Filter, primary.....	P608666 ...3
Filter, safety.....	P601560 ...3
Hump hose.....	P105610
Informer™ indicator 25" H <sub>2</sub> O.....	X002277
Latch.....	P777366 ...3
Outlet band clamp.....	P148345
U-clip (4 clips).....	P784517 ...3
Vacuator™ Valve.....	P112803 ...3

D100031, D100032, D100068	PSD
Cover.....	P784298 ...3
Cover, with watertight seal.....	P619482
Elbow, 45°.....	P105547
Elbow, 90°.....	P105535
Filter, primary.....	P608676 ...3
Filter, safety.....	P601560 ...3
Hump hose.....	P105612
Informer™ indicator 25" H <sub>2</sub> O.....	X002277
Latch.....	P777366 ...3
Outlet band clamp.....	P148347
U-clip (4 clips).....	P784517 ...3
Vacuator™ Valve.....	P112803 ...3

D120035, D120036	PSD
Cover.....	P608171 ...3
Elbow, 45°.....	P105547
Elbow, 90°.....	P105535
Filter, primary.....	P608667 ...3
Filter, safety.....	P607557 ...3
Hump hose.....	P105612
Informer™ indicator 25" H <sub>2</sub> O.....	X002277
Latch.....	P777366 ...3
Outlet band clamp.....	P148347
U-clip (4 clips).....	P784517 ...3
Vacuator™ Valve.....	P112803 ...3

D120037, D120038	PSD
Cover.....	P608180 ...3
Elbow, 45°.....	P105547
Elbow, 90°.....	P105535
Filter, primary.....	P608677 ...3
Filter, safety.....	P607557 ...3
Hump hose.....	P105612
Informer™ indicator 25" H <sub>2</sub> O.....	X002277
Latch.....	P777366 ...3
Outlet band clamp.....	P148347
U-clip (4 clips).....	P784517 ...3
Vacuator™ Valve.....	P112803 ...3

D140110, D140111	PSD
Cover, with watertight seal.....	P623026 ...3
Elbow, 45°.....	P105548
Elbow, 90°.....	P105536
Elbow, 90° reducing.....	P215307
Filter, primary.....	P621983 ...3
Filter, safety.....	P621984 ...3
Hump hose.....	P105613
Informer™ indicator 25" H <sub>2</sub> O.....	X002277
Latch.....	P629526 ...3
Outlet band clamp.....	P148348
U-clip (9 clips).....	P622745 ...3
Vacuator™ Valve.....	P112803 ...3
Gasket.....	P623192

**NOTES:**  
3 = Shipped with air cleaner initially



# Air Filtration

## for Tier IV Engines



**PowerCore®**  
A Donaldson Filtration Technology

Quality  
you expect

Performance  
you need

Support  
you won't find  
anywhere else

**Donaldson  
Delivers**

### PSD AIR CLEANERS FOR CUMMINS ENGINE APPLICATIONS

Engine Model	Horsepower Range		Engine Size (L)	Speed (CID)	Speed (RPM)	Est. Nom. Airflow CFM	Donaldson Air Cleaner
--------------	------------------	--	-----------------	-------------	-------------	-----------------------	-----------------------

#### Agriculture, Construction/Industrial Equipment

B3.3	74	85	3.3	201	2600	242	PSD08
B3.3	60	65	3.3	201	2600	136	PSD08

#### Agriculture, Construction/Industrial Equipment, Oil and Gas

QSB3.3	75	110	3.3	201	2200	237	PSD08
QSB4.5 (Tier 4 Final)	121	173	4.5	275	2200	398	PSD09
QSB6.7 (Tier 4 Final)	146	310	6.7	409	2200	713	PSD10
QSC	205	305	8.3	506	2100	569	PSD10
QSF 2.8 (Tier 4 Final)	49	74	2.8	171	1600	170	PSD08
QSF 3.8 (Tier 4 Final)	74	130	3.8	232	2500	299	PSD09
QSL	250	365	8.9	543	2000	581	PSD10
QSL9 (Tier 4 Final)	250	400	9	549	2200	920	PSD14
QSM	290	400	10.8	659	2000	705	PSD10
QSX11.9	300	500	11.9	726	2200	855	PSD12
QSG12 (Tier 4 Final)	335	513	12	732	1900	1180	PSD14
QSX15 (Tier 4 Final)	450	675	15	912	2100	1553	PSD12 x 2

#### Construction/Industrial Equipment, Oil and Gas, Mining

QSK19	506	700	19	1159	2000	1241	PSD14
QSK19	506	700	19	1159	2000	1610	PSD14
QSK50 (Tier 4 Final)	1487	2000	50	3661	1800	4600	PSD14 x 4
QSK60 (Tier 4 Final)	1875	2850	60	3066	1800	6555	PSD14 x 5

#### Heavy-duty Truck, RV, Emergency Vehicle

ISX11.9	370	500	11.9	726	2100	816	PSD12
ISX15	455	600	15	915	2100	1029	PSD14

#### Medium-duty Truck, Bus, Emergency Vehicle

ISB6.7	260	360	6.7	409	2600	569	PSD10
ISC8.3	270	380	8.3	506	2200	596	PSD10
ISL9	345	450	9	549	2200	647	PSD10

#### On-highway, European, Euro II

ISMe	345	440	10.8	659	1900	670	PSD10
ISLe	350		8.9	543	2100	610	PSD10
ISBe — 6 Cylinder	275	285	6.7	409	2500	547	PSD10

#### On-highway, European, Euro III

ISMe	335	420	10.8	659	1900	670	PSD10
ISLe	209	260	8.9	543	2100	610	PSD10
ISBe - 4 Cylinder	138	185	4.5	275	2500	367	PSD09
ISBe - 6 Cylinder	285	275	6.7	409	2500	547	PSD10

#### On-highway, European, Euro IV

ISMe	350	445	10.8	659	1900	670	PSD10
ISLe	280	400	8.9	543	2100	610	PSD10
ISBe - 4 Cylinder	140	207	4.5	275	2500	367	PSD09
ISBe - 6 Cylinder	205	300	6.7	409	2500	547	PSD10

#### On-highway, European, Euro V

ISMe	350	445	10.8	659	1900	670	PSD10
ISLe	280	400	8.9	543	2100	610	PSD10



# Finding PowerCore® air cleaners and filters online has never been easier.



## DISCOVER.

Looking for a complete filtration system or advice on choosing the right filter option? Go online to **donaldson.com** to learn about the broad range of filtration solutions offered by Donaldson – and to help you decide which option is right for your application.

## DECIDE.

If you're an equipment owner that needs to purchase filters and parts – it's easy to find the right Donaldson part, make an online shopping list and even request a quote from one of our distributors. We make finding filters *easier than easy* at **shop.donaldson.com**.



**PowerCore®**  
A Donaldson Filtration Technology

**PowerCore®  
air cleaners deliver . . .**

- System design flexibility
- Metal-free, lightweight materials
- Rugged construction
- Straight-through airflow technology invented by Donaldson
- RadialSeal™ advanced sealing technology
- Ideal for light dust environments
- Connect the PCD to an external pre-cleaner for medium to heavy dust environments. (See page 177 for external pre-cleaner options.)

The PCD air cleaner family offers single-stage filtration in a single, compact unit that delivers superior filtration performance using our PowerCore Filtration Technology.



**PowerCore® Straight-Through Airflow Schematic**

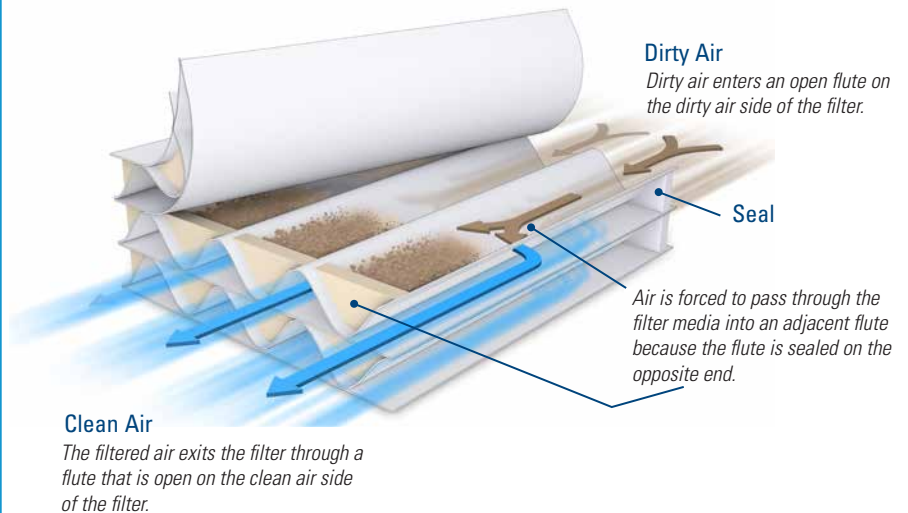

**Big Performance, Small Footprint**

**PowerCore air filters are up to 65% smaller than a conventional RadialSeal™ filter.**



## PCD PowerCore Air Cleaner is Ideal for Light Dust Environments



**PowerCore**  
A Donaldson Filtration Technology

This air cleaner family offers single-stage filtration in a compact unit that delivers superior filtration performance using our PowerCore® Filtration Technology.

This non-metal air cleaner (except for cover clamps) is ideal for equipment operating in light dust environments.

### Applications

- Light dust conditions with engine airflow ranges up to 974 cfm.
- Obround housing shape allows for a narrow or wide mounting orientation.
- Models have side filter service access
- Sustained temperature tolerance: -40 °F to 180 °F / -40 °C to 82 °C

### Features

- More compact at a given performance level than standard pleated filters
- Non-metal filters
- Improved engine protection: no media movement, expansion, contraction or bunching
- Improved contaminant encapsulation: dust and dirt stay contained in filter during service
- Improved handling and maintenance: lighter and smaller
- Easily serviced; no tools required to remove or replace cover, changing filters is a snap
- Built in mounting brackets eliminate the need to purchase separate mounting bands
- Available with either inline inlet/outlet or offset inlet/outlet. See images on next page.

### PCD09, PCD10

Exploded view of D090108

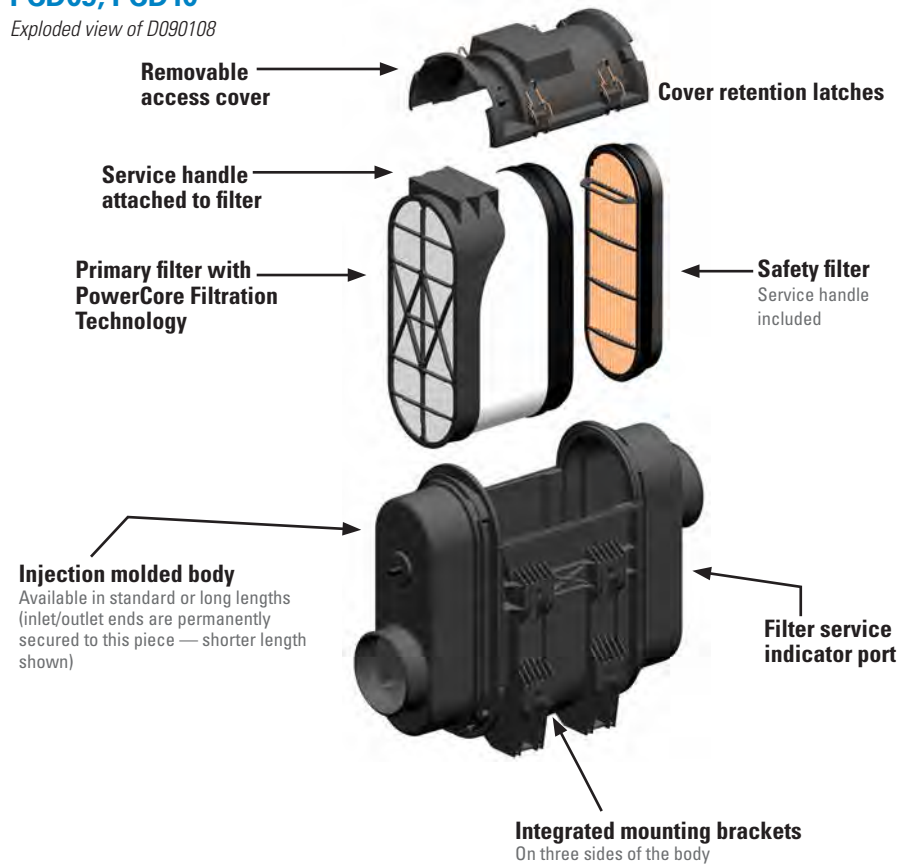

*Easy Service. The filter can be easily removed with the built-in grab handle.*



## Excellent Performance in Half the Space

### Inlet/outlet orientation

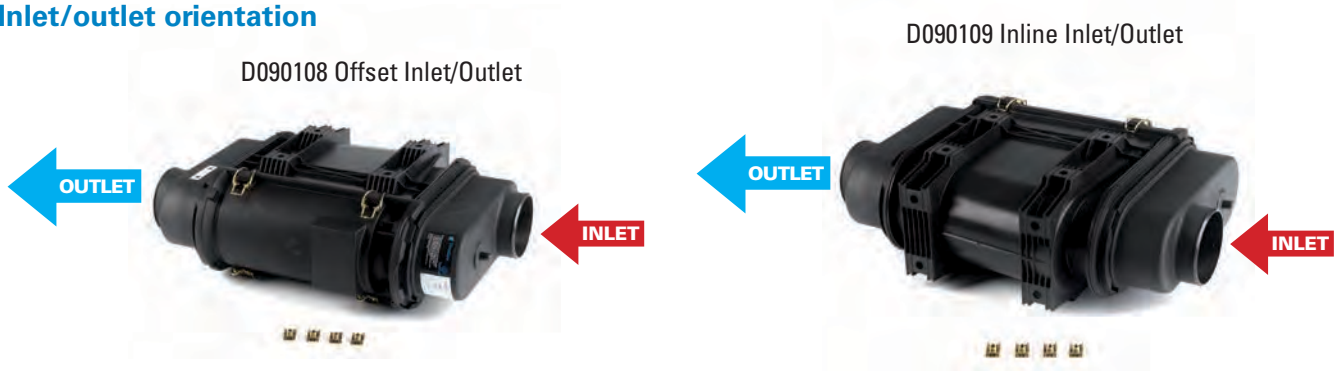

### Mounting Flexibility

With mounting locations on three sides of the housing, the PCD series offers a great deal of flexibility for a wide variety of installations.



U-clips are shipped with each air cleaner. Affix these to the mounting location (all in the same direction) and slide the housing into place. See dimensional illustration for u-clip mounting hole pattern on page 50.

The PCD air cleaner needs to be mounted to equipment on at least one mounting location (base, or either of two sides). It can also be mounted at two points, using the base and one side. It should not be mounted using the two side mounting locations — as this will cause pressure/flexing, and could result in leaks. (See illustration, on right. Xs represent u-clips mounted on both sides adjacent to the access cover.) The u-clips accept M8 threaded fasteners. Maximum torque is 18 N•m.

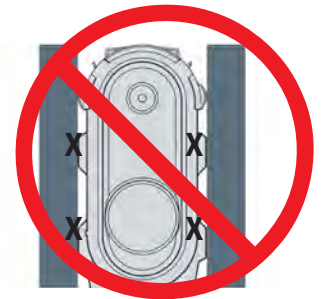

### Mounting Orientation Guidelines

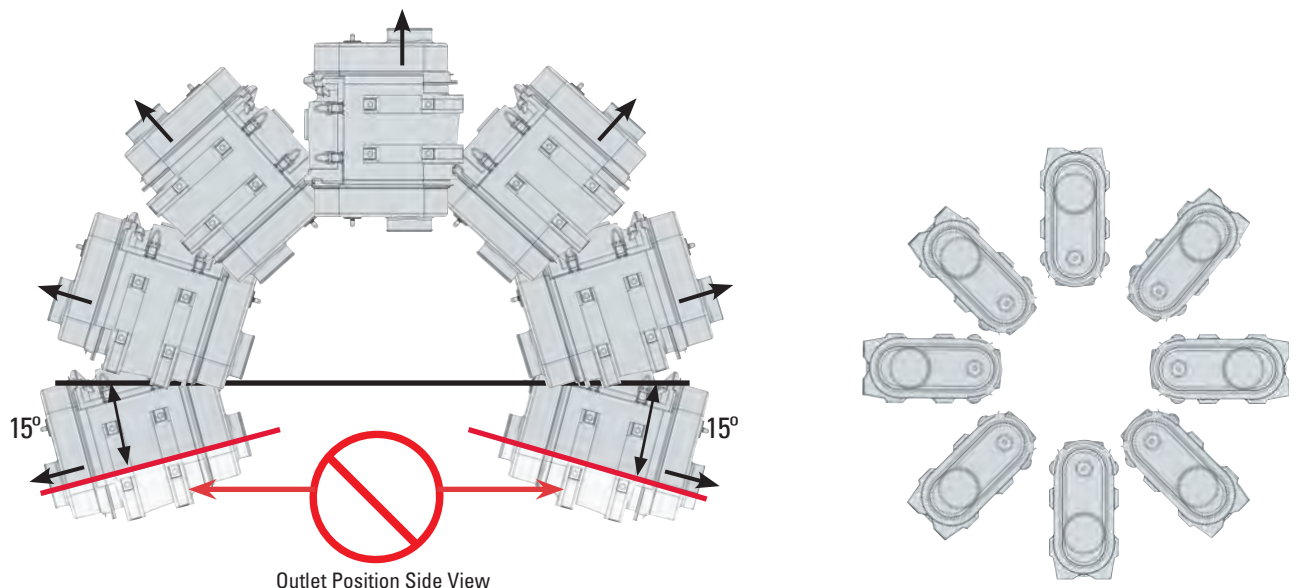

#### CAUTION: Outlet Tube Mounting Position

The outlet tube angled 15° below the horizontal axis could allow dust or foreign objects to fall into the air duct or engine during servicing.



**When Selecting an Air Cleaner . . .**

Determine the airflow requirements of your engine, then find the corresponding cfm airflow in the table below. The restriction numbers (shown in inches of water) indicate the approximate initial restriction of each model air cleaner at that cfm. If there are two air cleaner models that fit your parameters, choosing the one with the lower restriction will provide longer filter service life. When calculating total initial restriction of the entire air intake system, include the restriction caused by ducting, elbows, and pre-cleaners. See pages 257-258 for ducting restriction estimates.

**Initial Airflow Restriction**

Air Cleaner Model	CFM @ "H <sub>2</sub> O		
	6"	8"	10"
D090108	416	487	550
D090109	416	487	550
D090114	422	493	555
D090115	422	493	555
D100142	725	848	956
D100143	725	848	956
D100145	746	867	974
D100146	746	867	974



PCD Offset Inlet/Outlet Options

**PCD Air Cleaner Performance Curves\***

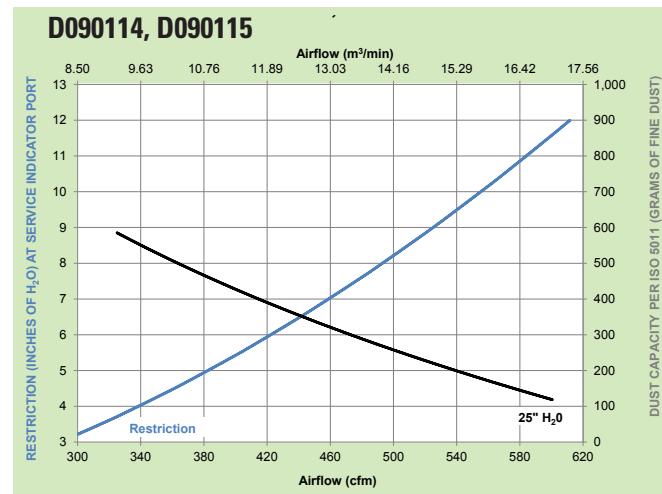
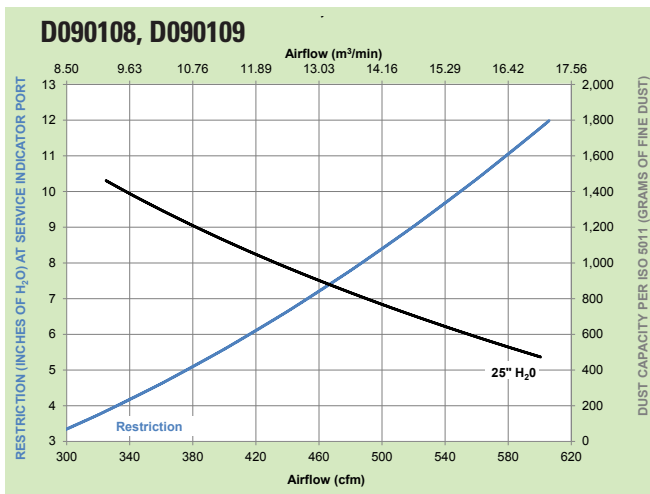

\*Results generated using laboratory testing pursuant to ISO5011. Actual performance during use may vary depending on multiple factors, including specific product configuration, external conditions and application.



continued — PCD Air Cleaner Performance Curves

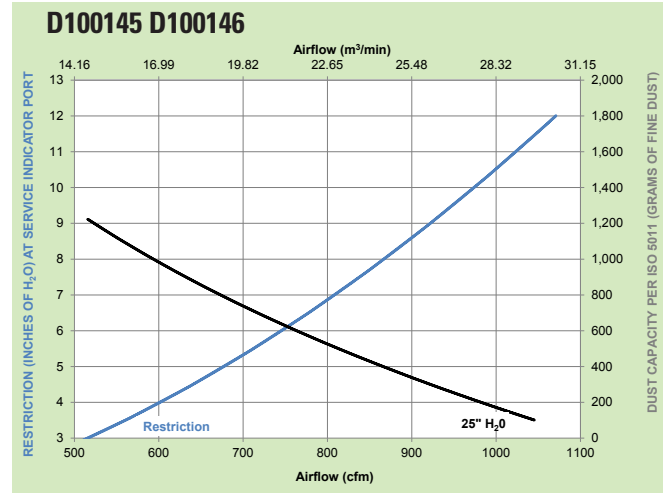
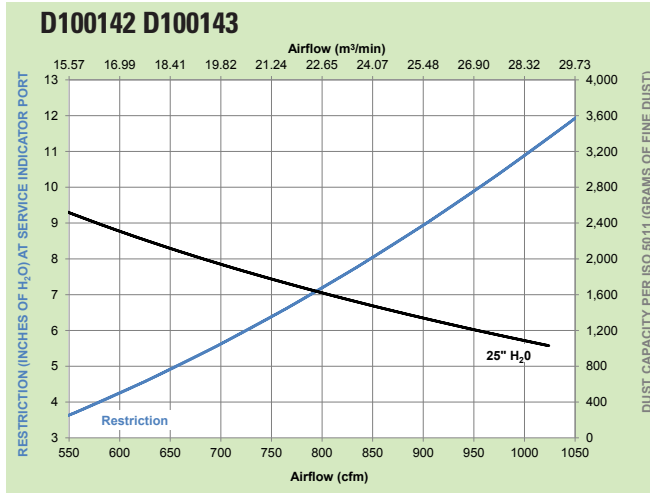

**Service Parts & Accessories**

<b>D090114, D090115</b>	<b>PCD</b>
Cover.....	P785651 ...3
Elbow, 45°.....	P105545
Elbow, 90°.....	P105533
Elbow, 90° reducing.....	P121482
Filter, primary.....	P608665 ...3
Filter, safety.....	P606121 ...3
Hump hose.....	P105609
Informer™ indicator 25" H <sub>2</sub> O.....	X002277
Latch.....	P777366 ...3
Outlet band clamp.....	P148343
U-clip (4 clips).....	P784517 ...3

<b>D090108, D090109</b>	<b>PCD</b>
Cover.....	P786989 ...3
Elbow, 45°.....	P105545
Elbow, 90°.....	P105533
Elbow, 90° reducing.....	P121482
Filter, primary.....	P608675 ...3
Filter, safety.....	P606121 ...3
Hump hose.....	P105609
Informer™ indicator 25" H <sub>2</sub> O.....	X002277
Latch.....	P777366 ...3
Outlet band clamp.....	P148343
U-clip (4 clips).....	P784517 ...3

<b>D100145, D100146</b>	<b>PCD</b>
Cover.....	P784279 ...3
Cover, with watertight seal.....	P619481
Elbow, 45°.....	P109021
Elbow, 90°.....	P107844
Elbow, 90° reducing.....	P143895
Filter, primary.....	P608666 ...3
Filter, safety.....	P601560 ...3
Hump hose.....	P105610
Informer™ indicator 25" H <sub>2</sub> O.....	X002277
Latch.....	P777366 ...3
Outlet band clamp.....	P148345
U-clip (4 clips).....	P784517 ...3

<b>D100142, D100143</b>	<b>PCD</b>
Cover.....	P784298 ...3
Cover, with watertight seal.....	P619482
Elbow, 45°.....	P109021
Elbow, 90°.....	P107844
Filter, primary.....	P608676 ...3
Filter, safety.....	P601560 ...3
Hump hose.....	P105610
Informer™ indicator 25" H <sub>2</sub> O.....	X002277
Latch.....	P777366 ...3
Outlet band clamp.....	P148345
U-clip (4 clips).....	P784517 ...3

**NOTES:**  
3 = Shipped with air cleaner initially



PCD09, PCD10

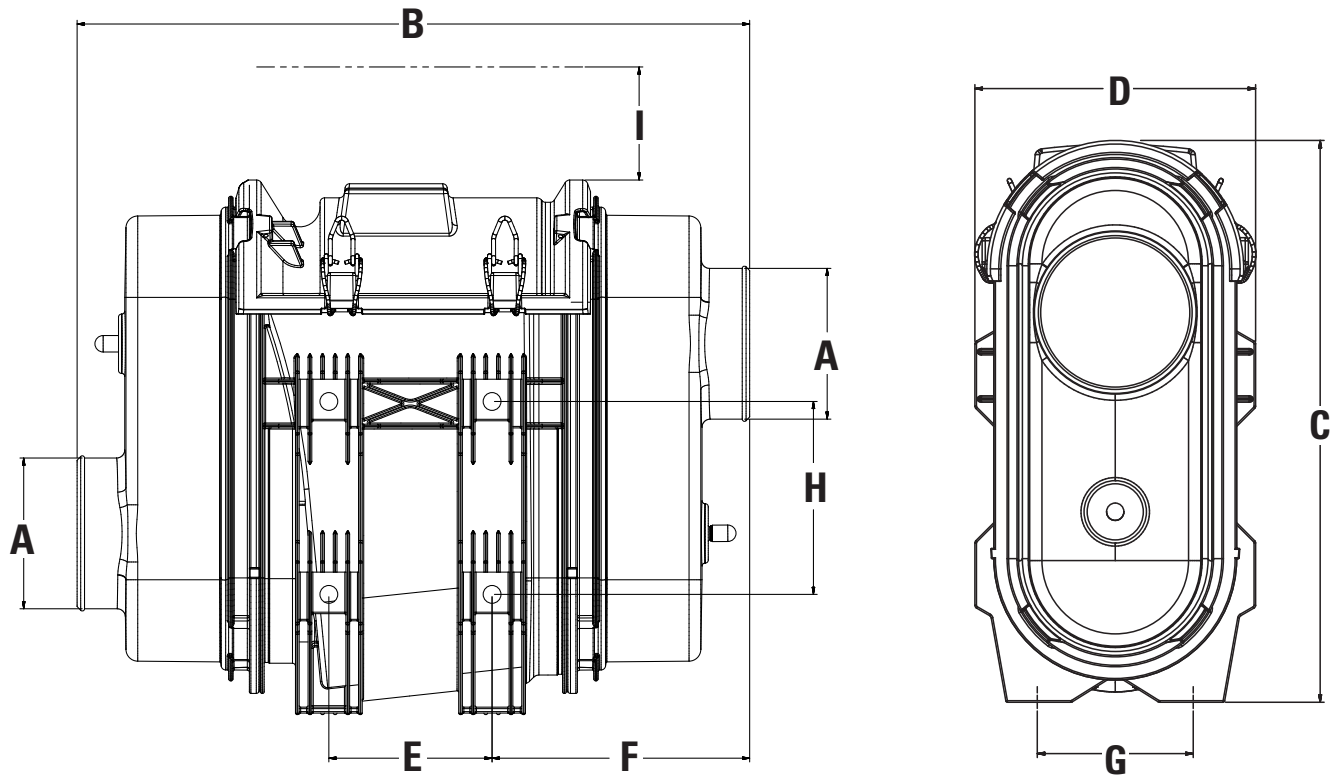

**Note:** a minimum service clearance of 50mm (2.00") is required for wire latches.



PCD09



PCD10

## PCD09, PCD10 Specifications (Letters are keyed to drawings)

Inlet Orientation: I=Inline; O=Off-set

Part No. / Orientation	A		B		C		D		E		F		G		H		Service Clearance (I)		Weight	
	mm	in	mm	in	mm	in	mm	in	mm	in	mm	in	mm	in	mm	in	mm	in	kg	lbs
D090108 O	102	4.00	553	21.77	365	14.37	180	7.09	180	7.09	183	7.21	100	3.94	130	5.12	356	14.0	4.8	10.5
D090109 I	102	4.00	553	21.77	365	14.37	180	7.09	180	7.09	183	7.21	100	3.94	130	5.12	356	14.0	4.8	10.5
D090114 O	102	4.00	453	17.85	360	14.18	180	7.09	110	4.33	173	6.83	100	3.94	130	5.12	330	13.0	4.1	9.1
D090115 I	102	4.00	453	17.85	360	14.18	180	7.09	110	4.33	173	7.21	100	3.94	130	5.12	330	13.0	4.1	9.1
D100142 O	127	5.00	536	21.10	384	15.12	254	10.01	210	8.27	165	6.50	110	4.33	110	4.33	356	14.0	5.9	13.0
D100143 I	127	5.00	536	21.10	384	15.12	254	10.01	210	8.27	165	6.50	110	4.33	110	4.33	356	14.0	5.9	13.0
D100145 O	127	5.00	436	17.17	375	14.75	254	10.01	110	4.33	165	6.50	110	4.33	110	4.33	356	14.0	5.2	11.4
D100146 I	127	5.00	436	17.17	375	14.75	254	10.01	110	4.33	165	6.50	110	4.33	110	4.33	356	14.0	5.2	11.4

This servicing information is provided as a best practices guide. It is not intended to replace or supersede the service instructions supplied by your engine or vehicle manufacturer. Note: Your air cleaner service cover may be in a different position than shown.

## 1 Check the Restriction

Replace the filter only when the restriction level has reached the maximum recommended by the engine or equipment manufacturer or on a regular scheduled service.



## 2 Remove the Primary Filter

Push down on the service handle to tilt the filter to a 5° angle. This will loosen the seal. Then, pull up on the service handle to remove the filter from the housing.



## 3 Visually Inspect the Safety Filter

Remove any excess dirt and wipe out the housing with a damp cloth before servicing the safety filter. Visually inspect the safety filter but do not remove it unless it is damaged or due for change-out. Verify that the safety filter is properly seated in the housing. The safety filter should be replaced every three primary filter changes.



*NEVER use a pressure sprayer to clean out the air cleaner housing while it is installed on the machine.*

## 4 Remove Safety Filter if Indicated or if Excessively Contaminated

To remove the safety filter, use the plastic handle on the face of the safety filter. Pull the filter toward the center of the housing and remove it. Ensure that the outlet tube sealing area is clean and undamaged. If the safety filter is removed and the new filter is not to be installed immediately, be sure to cover the seal tube with a cloth so that dirt is not admitted. After removing the safety filter, wipe the air cleaner housing interior and seal surfaces with a clean, damp cloth.



## 5 Inspect the New Filters

Visually check for cuts, tears or indentations on the sealing surfaces and the media pack before installation. If any damage is visible, do not install.



*The safety filter should be replaced every three primary filter changes.*

Continued on next page





### 6 Replace the Safety Filter

If replacing the safety filter, use the plastic handle. Slide the filter at an angle into the outlet side and push it in place until the filter seats firmly and evenly within the housing.



### 7 Insert the Primary Filter

Slide the filter down at approximately a 5° angle until it makes contact with the end of the housing. Rotate the filter toward the outlet section to complete the seal.



### 8 Replace the Service Cover

Place the service cover in position and fasten the metal latches. If the cover doesn't seat, remove and re-check the filter position and access cover orientation.



### 9 Inspect the Entire Air Cleaner System

Make sure that inlet and outlet connections are in good condition. Torque to and do not exceed 40 in•lb. Replace rubber connectors if necessary and reset the service indicator.



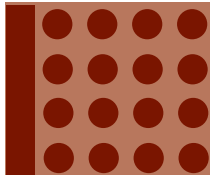

## The Next Generation of 2-stage Air Cleaners

PowerPleat™ air cleaners offer equipment manufacturers a powerful new filtration solution to protect engines from dust and contamination.



### Section Index

PowerPleat 05.....	54
Service Instructions.....	58
PowerPleat 11; 13.....	60
Service Instructions.....	64

PowerPleat air cleaners offer an optimal balance of air cleaner benefits, including:

#### Reliable Protection

Using Donaldson’s proven sealing technology, PowerPleat air cleaners provide reliable engine protection to equipment manufacturers and end users in the harshest, most demanding applications on the planet.

#### Higher Capacity

Optimized first stage separation in PowerPleat air cleaners means larger dust capacity than competitive air cleaners of equal size.

#### Easy integration

The innovative plastic design allows for system simplification that saves money — there’s no need for external pre-cleaners, scavenged systems or additional mounting brackets. Multiple inlet/outlet configurations make PowerPleat air cleaner system integration easy.

**Contact Donaldson for PowerPleat availability in your region.**



## PowerPleat™ 05 — Compact, Durable All-plastic Housing

Servicing is quick and easy

### Applications

- Provides up to 95 cfm airflow without a safety filter and 86 cfm airflow with a safety filter.
- Installation can be horizontal, vertical, or even at an angle (as long as Vacuator™ Valve points down)
- Temperature tolerance: -40 °F to 180 °F / -40 °C to 83 °C (Do not install next to turbocharger, muffler, exhaust pipes, or other high-temperature components.)

### Equipment Types

- Skid Steers and light construction.
- Compressors and generator sets.
- Small to medium agriculture.
- All-Terrain Vehicles (ATVs).
- Lawn maintenance.

### Air Cleaner Features

- Durable plastic housing — corrosion-free and lightweight.
- Two-stage air filtration. Built-in, tangential pre-cleaner ahead of primary filter removes up to 85% of incoming dust.
- Twist-on service cover with latch makes servicing easy — no tools required.
- Choose 90° or straight outlet to fit your application. Both outlets are rotatable to accommodate installation requirements.
- Filter service indicator port is included.

### Filter Features

- One piece, molded urethane endcaps encase the filter media and liners.
- Safety filter protects engine during primary filter change outs. All PowerPleat models can accept safety filters. Specification table shows which air cleaner models ship with a safety filter installed.



Contact Donaldson for PowerPleat availability in your region.

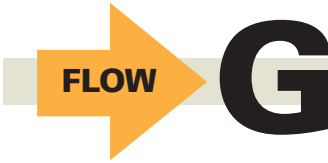

**Air in the Side, Out the End** (standard flow filters)

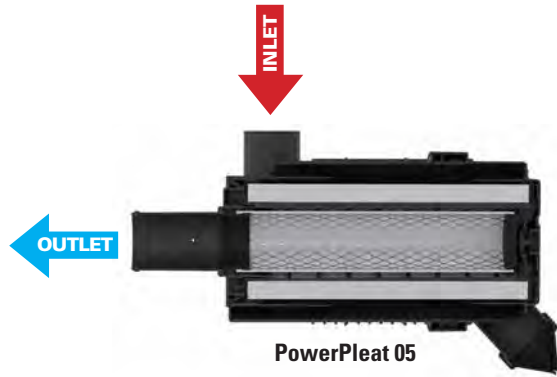

**When Selecting an Air Cleaner . . .**

Determine the airflow requirements of your engine, then find the corresponding cfm airflow in the table at right. The restriction numbers (shown in inches of water) indicate the approximate initial restriction of each model air cleaner at that cfm. If there are two air cleaner models that fit your parameters, choosing the one with the lower restriction will provide longer filter service life. When calculating total initial restriction of the entire air intake system, include the restriction caused by ducting, elbows, and pre-cleaners. See pages 257-258 for ducting restriction estimates.

**Initial Airflow Restriction**

Airflow CFM @ H <sub>2</sub> O			Air Cleaner Model
6"	8"	10"	
<b>MODELS WITH PRIMARY &amp; SECONDARY FILTERS</b>			
61	72	81	G052741
65	76	86	G052742
<b>MODELS WITH PRIMARY FILTER ONLY</b>			
70	80	90	G052828
73	85	95	G052829

**PowerPleat 05 Air Cleaner Performance Curves\***

**G052741 90° Outlet**

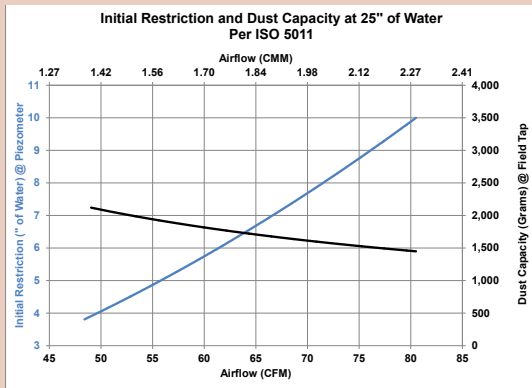

**G052742 Straight Outlet**

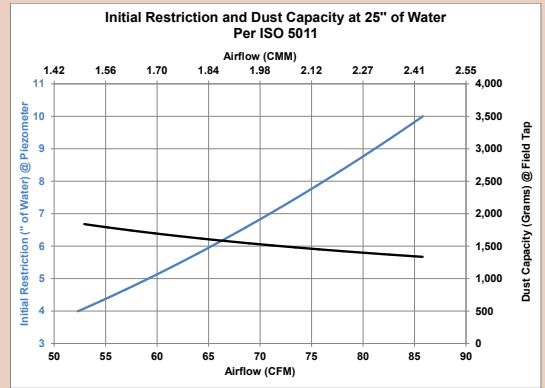

**G052828 90° Outlet**

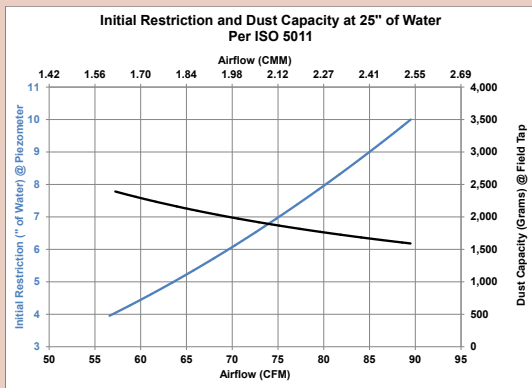

**G052829 Straight Outlet**

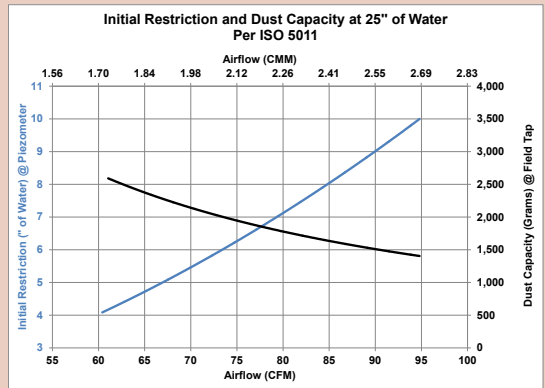

\*Results generated using laboratory testing pursuant to ISO5011. Actual performance during use may vary depending on multiple factors, including specific product configuration, external conditions and application.



### PowerPleat 05 Specifications

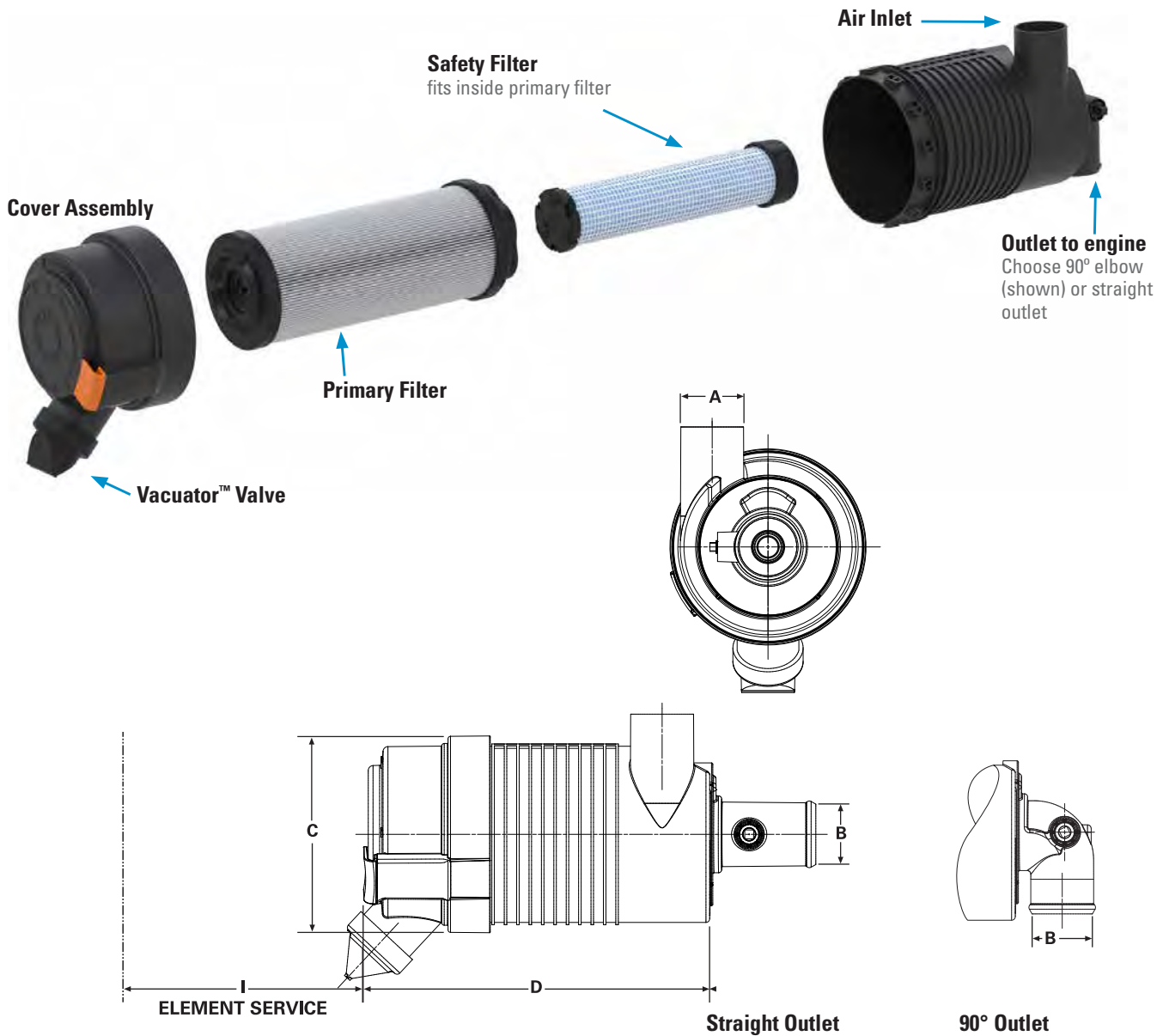

### PowerPleat 05

Air Cleaner Models	With Safety Filter?	Inlet Dia. (A)	Outlet Dia. (B)	Body Dia. (C)	Housing Length (D)	Service Clear. (I)	Weight lbs kg
<b>POWERPLEAT™ MODELS WITH 90° OUTLET TUBES</b>							
G052741	Yes	2.00" 51mm	2.00" 51mm	5.60" 142mm	10.85" 276mm	8.27" 210mm	1.9lb .9kg
G052828	No	2.00" 51mm	2.00" 51mm	5.60" 142mm	10.85" 276mm	8.27" 210mm	1.9lb .9kg
<b>POWERPLEAT™ MODELS WITH STRAIGHT TUBES</b>							
G052742	Yes	2.00" 51mm	2.00" 51mm	5.60" 142mm	10.85" 276mm	8.27" 210mm	1.9lb .9kg
G052829	No	2.00" 51mm	2.00" 51mm	5.60" 142mm	10.85" 276mm	8.27" 210mm	1.9lb .9kg



## PowerPleat 05 Service Parts & Accessories

### G052741, G052742 PowerPleat 05

Cover.....	P628588	.....8
Filter, primary.....	P628390	.....3
Filter, safety.....	P628170	.....3
Informer™ indicator 25" H <sub>2</sub> O.....	X002277	
Inlet hood, plastic.....	H002068	
Mounting bands, metal.....	H008443	
Mounting Bands, plastic.....	P777730	
Outlet band clamp.....	P115200	
Vacuator™ Valve.....	P522958	

### G052828, G052829 PowerPleat 05

Cover.....	P628588	.....8
Filter, primary.....	P628390	.....3
Filter, safety.....	P628170	.....4
Informer™ indicator 25" H <sub>2</sub> O.....	X002277	
Inlet hood, plastic.....	H002068	
Mounting bands, metal.....	H008443	
Mounting Bands, plastic.....	P777730	
Outlet band clamp.....	P115200	
Vacuator™ Valve.....	P522958	

#### NOTES:

- 3 = Shipped with air cleaner initially
- 4 = Safety filter is designed to fit this air cleaner, but was not originally shipped with it (note that adding a safety filter will decrease the maximum airflow throughput)
- 8 = Cover assembly includes latches but no Vacuator™ Valve

### Polymer Mounting Band

The one-piece, durable polymer mounting band will securely hold the housing in position. The band has tabs on the inside circumference which fit exactly into notches on the PowerPleat housing. Donaldson polymer bands are completely non-corrosive, lightweight, easy to install, and economical.

The band tightens around the air cleaner when the base of the band is bolted to a support, providing a fixed, stable mounting — even in high vibration applications.

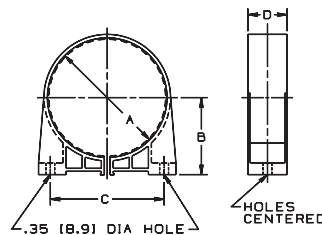

### Metal Mounting Band

The metal mounting band has a spring-loaded bolt at the top to maintain a constant hold on the housing throughout high and low temperature extremes.

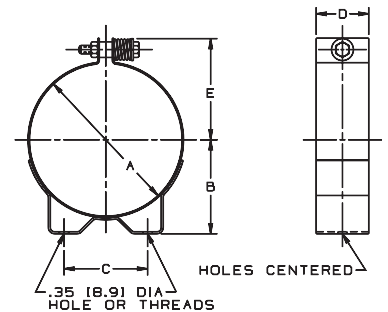

#### Maximum Torque

Polymer Bands:  
11 lbs-ft / 14.8 N•m

Metal Bands:  
12 lbs-ft / 16.2 N•m

#### Application Note:

Polymer bands allow the air cleaner housing to be rotated and positioned at 10° increments.

#### PowerPleat Mounting Bands (Order one band per PowerPleat air cleaner)

Part Number	A		B		C		D		E		Weight	
	in	mm	in	mm	in	mm	in	mm	in	mm	lbs	kgm
<b>POLYMER BAND</b>												
P777730	5.75	146	3.52	90	5.35	136	1.99	51	n/a		0.37	167
<b>METAL BAND</b>												
H008443	5.75	146	3.54	90	3.15	80	1.99	51	3.83	97	1.30	590

**WARNING:** Do not use any other mounting bands or straps with PowerPleat air cleaners. Use of an unapproved mounting band voids warranty.



**PowerPleat 05** servicing information is provided as a best practices guide. It is not intended to replace or supersede the service instructions supplied by your engine or vehicle manufacturer.

### 1 Check the Restriction

Replace the filter only when the restriction level has reached the maximum recommended by the engine or equipment manufacturer or on a regular service schedule.



### 2 Clean Out the Vacuator™ Valve

If your air cleaner is equipped with a Vacuator™ Valve, visually check and physically squeeze it. Make sure the valve is flexible and not inverted, damaged or plugged. If damaged or missing, replace it.



### 3 Remove the Primary filter

Make sure engine is shut off. Pull orange latch handle outward from service cover, rotate cover counterclockwise until it stops turning, pull the cover straight away from the air cleaner body.

Grasp the end of the primary filter and pull it from the air cleaner while applying a slight side to side motion. **Do not** try to rotate the filter when removing it from the air cleaner.



### 4 Visually Check the Safety Filter and Clean Both Surfaces of the Outlet Tube

If your air cleaner has a safety filter, visually check it for signs of damage while in place. Do not remove the safety filter unless it is damaged or due for replacement. Also verify that the safety filter is properly seated in the housing.

The safety filter should be replaced every three primary filter changes, unless it has become excessively contaminated. Should it be necessary to wipe excessive contaminant from the primary seal surface, remove the safety element, block the outlet tube with a damp towel to gain access to clean primary seal surface. Inspect the outlet tube sealing area to make sure it is undamaged.

Contaminant on the sealing surface could hinder an effective seal and cause leakage. If the safety filter is to be replaced, avoid leaving the outlet tube exposed to the air. If there is to be a delay in installing the new safety filter, cover the air cleaner outlet tube to avoid admitting any dust.



*Continued on next page*



## 5 Inspect the Old Filter and New Filters

Inspect the old primary filter for any signs of leaks. A streak of dust on the inside of the filter is a telltale sign of a possible leak.

If you suspect a possible leak, verify the safety element is in good condition as it may need to be changed as well. If there is no safety element, make sure that there is no dust trails in the outlet tube. Also make sure to follow Step 8 to ensure all connections are tight so that dirty outside air cannot bypass the air cleaner.

Inspect the new filter for any damage that may have occurred through mishandling. NEVER install a damaged filter. Visually check the inside of the open end, which is the sealing area.

Do not wipe the filter's sealing area. PowerPleat filters have a lubricant on the seal to aid installation.



## 6 Insert the New Filter

First, if you're servicing the safety filter at this change-out, grasp the end of the filter and pull it out of the air cleaner while applying a slight side-to-side motion.

Block the outlet tube of the air cleaner using a small dampened towel prior to cleaning the seal and locking surfaces to avoid contaminating the induction system. With a clean damp cloth, thoroughly clean the inside of the housing, seal and locking surfaces if required.

After removing the dampened towel, seat the new safety filter properly into position by aligning the open end of the filter with the inside diameter of the outlet tube. Push filter into outlet tube while applying a slight side to side motion on the filter until it is fully seated in the tube.

Insert new filters carefully. To install primary filter, insert filter into air cleaner while rotating it until you feel the alignment ribs on the inside of the filter drop into the receiving slots in the outlet tube.

No cover pressure is required to hold the seal in place and you should NEVER use the service cover to apply pressure. This could damage the housing and fasteners and void the warranty. If the service cover presses against the filter before the cover is fully in place, the filter is not properly seated. Remove the cover and make sure the alignment ribs have connected with the receiving slots. Filters must be properly seated in order for service cover to be properly installed. Once the filter(s) is in place, secure the service cover.



*If you perform filter maintenance service on a schedule versus using service indicators, you may want to write the service date on the end cap of both filters.*

## 7 Install Service Cover

Slide cover onto the end of the air cleaner body with the vacuator valve positioned slightly counterclockwise from vertical until cover stops on end of body. Rotate the cover clockwise until it stops, and then push the latch handle into the cover. For best vacuator valve performance, it should be located in the six o'clock position.



## 8 Check Connectors for Tight Fit

Make sure service indicators are reset and in proper working order. Check that all mounting bands, clamps, bolts, and connections in the entire air cleaner system are tight. Check for holes in piping and repair or replace as needed. Any leaks in the intake piping will admit dust directly to the engine.





## PowerPleat™ 11, 13 — Protection for Large Equipment

### RadialSeal™ technology for quick and easy servicing

#### Applications

- PowerPleat 11 air cleaner provides up to 437 cfm airflow. The PowerPleat 13 air cleaner provides up to 597 cfm airflow.
- Temperature tolerance: -40 °F to 180 °F / -40 °C to 83 °C (Do not install next to turbocharger, muffler, exhaust pipes, or other high-temp components.)

#### Equipment Types

- Compressors and generator sets.
- Excavators, bull dozers, cranes and large construction.
- On- and off-highway vehicles.
- Marine and offshore equipment.

#### Air Cleaner Features

- Durable plastic housing — corrosion-free and lightweight
- Two-stage air filtration. Built-in, tangential pre-cleaner ahead of primary filter removes up to 85% of incoming dust.
- Easy to service. No tools needed. Usually done in 5 minutes or less.
- Clockwise and counterclockwise inlet orientation versions available.
- Easy-to-fasten latches secure cover.
- Service indicator port is included.
- Welded-on mounting bracket.
- A plastic inlet hood and stack (up to 18" /457mm tall) may be added.

#### Filter Features

- Filters have RadialSeal™ Sealing Technology that creates a reliable, critical seal and makes servicing easy.
- One piece, molded urethane endcaps encase the filter media and liners.
- Metal-free primary filter element.
- Safety filter protects engine during in-field filter change outs.



Contact Donaldson for PowerPleat availability in your region.



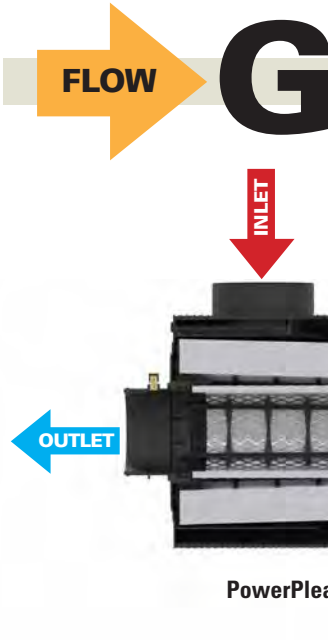

**Air in the Side, Out the End** (standard flow filters)

**When Selecting an Air Cleaner . . .**

Determine the airflow requirements of your engine, then find the corresponding cfm airflow in the table at right. The restriction numbers (shown in inches of water) indicate the approximate initial restriction of each model air cleaner at that cfm. If there are two air cleaner models that fit your parameters, choosing the one with the lower restriction will provide longer filter service life. When calculating total initial restriction of the entire air intake system, include the restriction caused by ducting, elbows, and pre-cleaners. See pages 257-258 for ducting restriction estimates.

**Initial Airflow Restriction**

Airflow CFM @ H <sub>2</sub> O			Air Cleaner Model
6"	8"	10"	
324	377	424	G110468 / G110469 (Short body)
337	390	437	G110474 / G110475 (Long body)
443	516	580	G130374 / G130375 (Short body)
463	534	597	G130372 / G130373 (Long body)

**PowerPleat 11 – 13 Air Cleaner Performance Curves\***

**G110468/G110469**

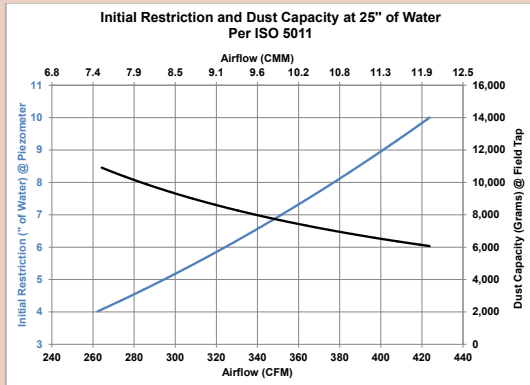

**G110474/G110475**

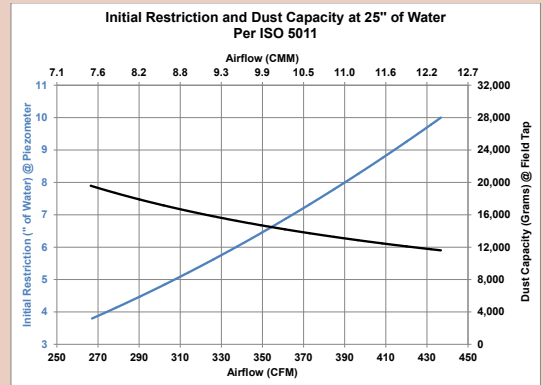

**G130374/G130375**

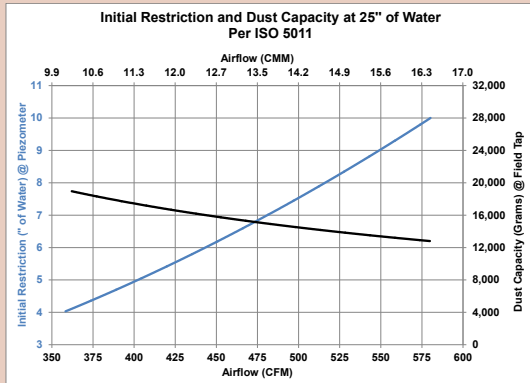

**G130372/G130373**

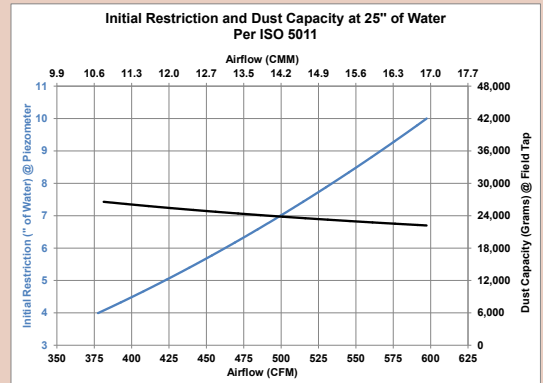

\*Results generated using laboratory testing pursuant to ISO5011. Actual performance during use may vary depending on multiple factors, including specific product configuration, external conditions and application.





## PowerPleat 11, 13 Specifications

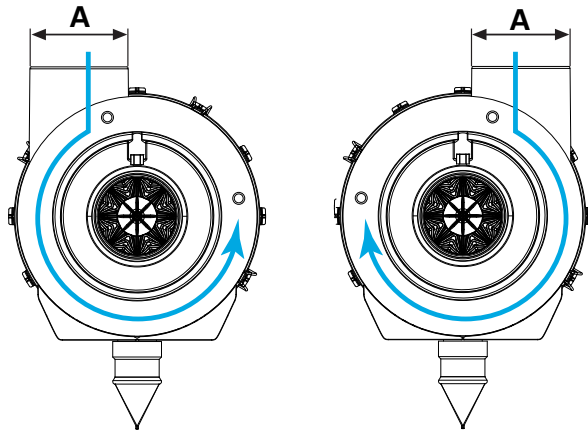

Counterclockwise (CCW) inlet    Clockwise (CW) inlet

Clockwise and counterclockwise inlet orientations are determined by the airflow path inside the air cleaner when looking into the outlet, as illustrated above with the blue arrows showing airflow.

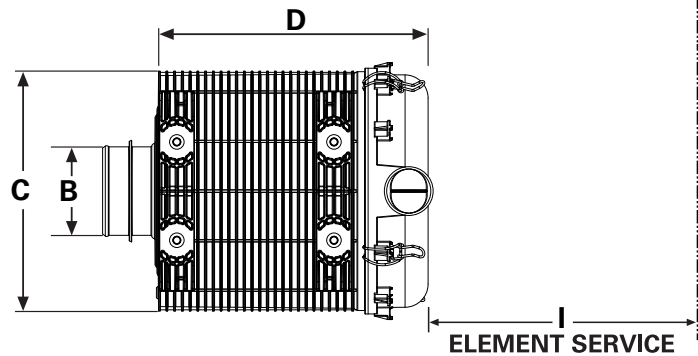
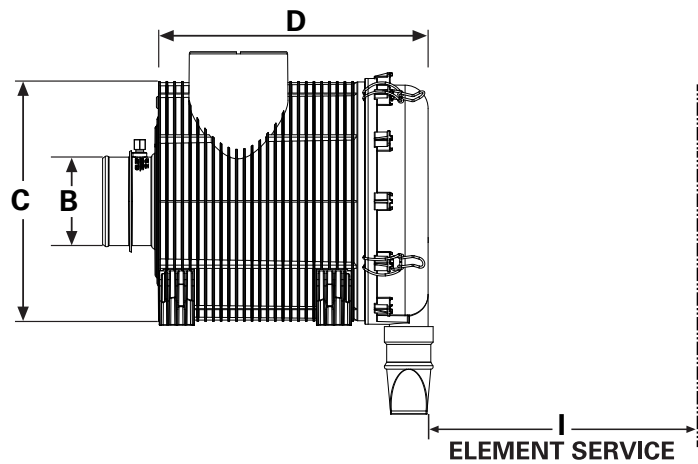

### PowerPleat 11, 13

Air Cleaner Models	Inlet Orientation	Inlet Dia. (A)	Outlet Dia. (B)	Body Dia. (C)	Housing Length (D)	Service Clear. (I)	Weight lbs kg
G110468	CCW	5.0" 127 mm	4.5" 114 mm	12.2" 310 mm	13.8" 350 mm	13.8" 350 mm	10.1 lb 4.6 kg
G110469	CW	5.0" 127 mm	4.5" 114 mm	12.2" 310 mm	13.8" 350 mm	13.8" 350 mm	10.1 lb 4.6 kg
G110474	CCW	5.0" 127 mm	4.5" 114 mm	12.2" 310 mm	19.3" 490 mm	19.3" 490 mm	12.6 lb 5.7 kg
G110475	CW	5.0" 127 mm	4.5" 114 mm	12.2" 310 mm	19.3" 490 mm	19.3" 490 mm	12.6 lb 5.7 kg
G130374	CCW	6.0" 152 mm	5.0" 127 mm	13.5" 342 mm	16.7" 425 mm	19.3" 490 mm	14.3 lb 6.5 kg
G130375	CW	6.0" 152 mm	5.0" 127 mm	13.5" 342 mm	16.7" 425 mm	19.3" 490 mm	14.3 lb 6.5 kg
G130373	CCW	6.0" 152 mm	5.0" 127 mm	13.5" 342 mm	20.9" 530 mm	23.6" 600 mm	17.6 lb 8.0 kg
G130372	CW	6.0" 152 mm	5.0" 127 mm	13.5" 342 mm	20.9" 530 mm	23.6" 600 mm	17.6 lb 8.0 kg

**PowerPleat 11, 13 Service Parts & Accessories**

**PowerPleat 11**

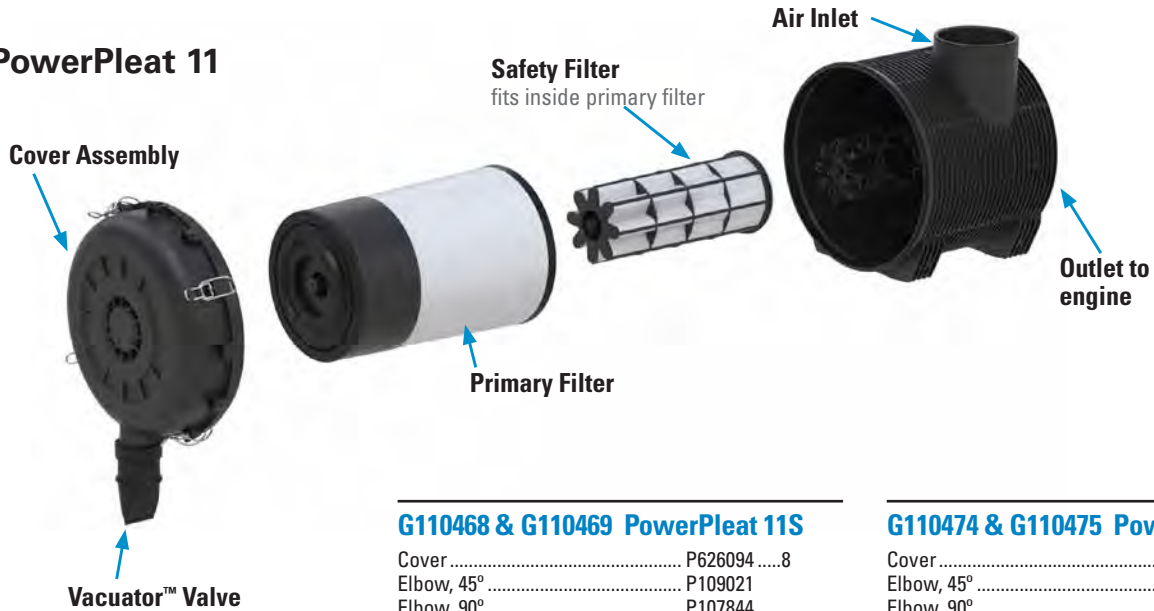

**G110468 & G110469 PowerPleat 11S**

Cover .....	P626094	.....8
Elbow, 45° .....	P109021	
Elbow, 90° .....	P107844	
Filter, primary .....	P626096	.....3
Filter, safety .....	P626104	.....3
Informer™ indicator 25" H <sub>2</sub> O .....	X002277	
Inlet hood, plastic.....	H000468	
Inlet hood, metal.....	H000170	
O-ring seal.....	P625983	
Outlet band clamp.....	P148344	
Vacuator™ Valve .....	P776008	

**G110474 & G110475 PowerPleat 11L**

Cover .....	P626094	.....8
Elbow, 45° .....	P109021	
Elbow, 90° .....	P107844	
Filter, primary .....	P628805	.....3
Filter, safety .....	P628802	.....3
Informer™ indicator 25" H <sub>2</sub> O .....	X002277	
Inlet hood, plastic.....	H000468	
Inlet hood, metal.....	H000170	
O-ring seal.....	P625983	
Outlet Hump Hose .....	P105610	
Outlet band clamp.....	P148344	
Vacuator™ Valve .....	P776008	

**PowerPleat 13**

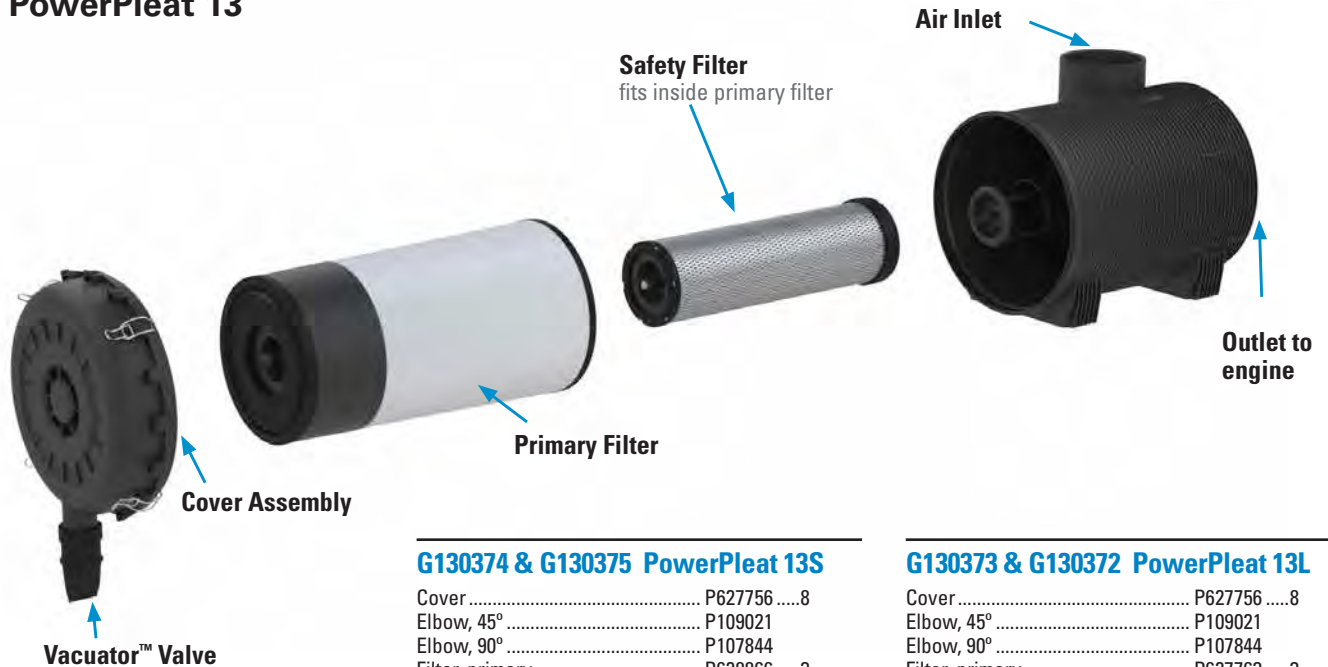

**G130374 & G130375 PowerPleat 13S**

Cover .....	P627756	.....8
Elbow, 45° .....	P109021	
Elbow, 90° .....	P107844	
Filter, primary .....	P628866	.....3
Filter, safety .....	P628862	.....3
Informer™ indicator 25" H <sub>2</sub> O .....	X002277	
Inlet hood, plastic.....	H000469	
Inlet hood, metal.....	H000165	
Outlet Hump Hose .....	P105610	
Outlet band clamp.....	P148345	
O-ring seal.....	P627758	
Vacuator™ Valve .....	P776008	

**G130373 & G130372 PowerPleat 13L**

Cover .....	P627756	.....8
Elbow, 45° .....	P109021	
Elbow, 90° .....	P107844	
Filter, primary .....	P627763	.....3
Filter, safety .....	P628203	.....3
Informer™ indicator 25" H <sub>2</sub> O .....	X002277	
Inlet hood, plastic.....	H000469	
Inlet hood, metal.....	H000165	
Outlet Hump Hose .....	P105610	
Outlet band clamp.....	P148345	
O-ring seal.....	P627758	
Vacuator™ Valve .....	P776008	

**NOTES:**

- 3 = Shipped with air cleaner initially
- 8 = Cover assembly includes latches but no Vacuator™ Valve



**PowerPleat 11, 13** servicing information is provided as a best practice guide. It is not intended to replace or supersede the service instructions supplied by your engine or vehicle manufacturer.

### 1 Check the Restriction

Replace the filter only when the restriction level has reached the maximum recommended by the engine or equipment manufacturer or on a regular service schedule.



### 2 Remove the Primary Filter and check the Vacuator™ Valve

Shut off the engine. Unlatch the service cover.

Visually inspect and check Vacuator™ Valve, and replace if needed.

Because of its RadialSeal™, the filter fits tightly over the outlet tube and there will be some initial resistance, similar to breaking the seal on a jar. Gently move the end of the filter back and forth slightly to break the seal while rotating. Pull straight out to avoid knocking the filter against the safety filter support frame.

Once the primary filter has been removed, clean the primary filter seal surface with a damp cloth.



Make sure the valve is flexible and not inverted, damaged or plugged. Replace it if damaged or if it looks like any of these images. A damaged or missing vac valve will disrupt the designed flow of air through the air cleaner.

### 3 Visually Check the Safety Filter and Clean Both Surfaces of the Outlet Tube

If your air cleaner has a safety filter, visually check the safety filter in place for signs of damage. Do not remove the safety filter unless it is damaged or due for replacement. Also verify that the safety filter is properly seated in the housing.

The safety filter should be replaced every three primary filter changes, unless it has become excessively contaminated. Use a clean damp cloth to wipe both the filter sealing surface and the inside of the outlet tube. Ensure that the outlet tube sealing area is undamaged.

Contaminant on the sealing surface could hinder an effective seal and cause leakage. If the safety filter is to be replaced, avoid leaving the outlet tube exposed to the air.

Never leave air cleaner sitting without a safety filter.



Note: The PowerPleat 13 is shown above. The PowerPleat 11 has a different style of safety. See image on page 63.

*Continued on next page*



## 4 Inspect the Old Filter

Inspect the old primary filter for any signs of leaks. A streak of dust on the inside of the filter is a telltale sign of a possible leak.

If you suspect a possible leak, verify the safety element is in good condition as it may need to be changed as well. Also make sure to follow Step 8 to ensure all connections are tight so that dirty outside air cannot bypass the air cleaner.



## 5 Inspect the New Filter

Inspect the new filter for any damage that may have occurred through mishandling. NEVER install a damaged filter. Visually check the inside of the open end, which is the sealing area.

Do not wipe the filter seal area as the new Donaldson filter may have a lubricant on the seal to aid installation.



## 6 Insert the New Filter

First, if you're servicing the safety filter at this change-out, seat it properly into position before installing the primary filter. Insert new filters carefully. Seat the primary filter by hand, making certain it is inserted completely into the air cleaner housing. To complete a tight seal, apply pressure by hand at the outer rim of the filter, not the flexible center.

No cover pressure is required to hold the seal in place and one should NEVER use the service cover to apply pressure. This could damage the housing and fasteners and void the warranty. If the service cover presses against the filter before the cover is fully in place, remove the cover. With cover off, push the filter farther into the air cleaner by hand and then the cover will go on with no extra force. Once the filter is in place, secure the service cover.







### 7 Check Inlet Hoods and Pre-Cleaners

Check any intake hoods and pre-cleaner devices during maintenance routines.

A missing inlet hood will significantly shorten filter life. If your unit had a hood or pre-cleaner originally, make sure you replace it. Check openings and tubes on pre-cleaners to make sure they are not plugged. Replace any units that are damaged. Damaged or dented units will not operate properly.



### 8 Check Connectors for Tight Fit

Make sure service indicators are reset and in proper working order.

Check that all mounting bands, clamps, bolts, and connections in the entire air cleaner system are tight.

Check for holes in piping, and repair or replace as needed.

Any leaks in the intake piping will admit dust directly to the engine.



**For Diesel, Gasoline and Compressed Natural Gas Engines, and Hybrid Vehicles Operating in Light to Light/Medium Dust Conditions**

Over-highway trucks, stationary engines, light industrial vehicles, and sport utility/light trucks generally operate in low-dust environments. They still need top quality air filtration systems to protect them and keep them running at peak efficiency. Those operating in high carbon environments particularly need protection.



**Section Index**

EPG.....	68
Service Instructions.....	72
ERA.....	74
Service Instructions.....	77
EBA Konepac™.....	79
Service Instructions.....	82
ECG Konepac™.....	84
Service Instructions.....	88
EBB.....	90
Service Instructions.....	92



**PowerCore**  
A Donaldson Filtration Technology

**If you're looking for a new air cleaner, check out the PowerCore® air cleaner section first!**

**PCD Air Cleaners with PowerCore Filtration Technology offer improved filtration performance compared to our older E Series air cleaners.**



## Durable, Corrosion-Free Air Cleaner

### Improved Reliability, Superior Engine Protection, Easiest Serviceability

The EPG air cleaner series, which incorporates Donaldson RadialSeal™ Sealing Technology, offers improved reliability and durability, reduced weight and costs, and better serviceability.

EPG air cleaners: conquer underhood space limitations; are corrosion-free and lighter in weight than traditional metal units; are more sturdy than ever before; and have a reliable, easy-to-service design.

The filter inside the air cleaner is also quite different from filters with metal end caps. The one-piece molded end caps encase the ends of the media and filter liners. The filter fits over the housing outlet tube, creating a reliable seal — without the hassle of separate sealing gaskets.

Of the six models, three include a primary filter and three include a primary and safety filter.



*Whether you are going to service by miles, hours or restriction, keep accurate maintenance records and log or track your filter changes.*



*This EPG RadialSeal™ Air Cleaner is part of a complete Donaldson intake system. The entire engine air intake system is made of molded plastic. Between the intake scoop and the air cleaner are Donaldson Strata™ tubes, which provide pre-cleaning. Particulate from this stage is scavenged off and out through the exhaust system. In this system, the EPG air cleaner provides the second stage of cleaning.*

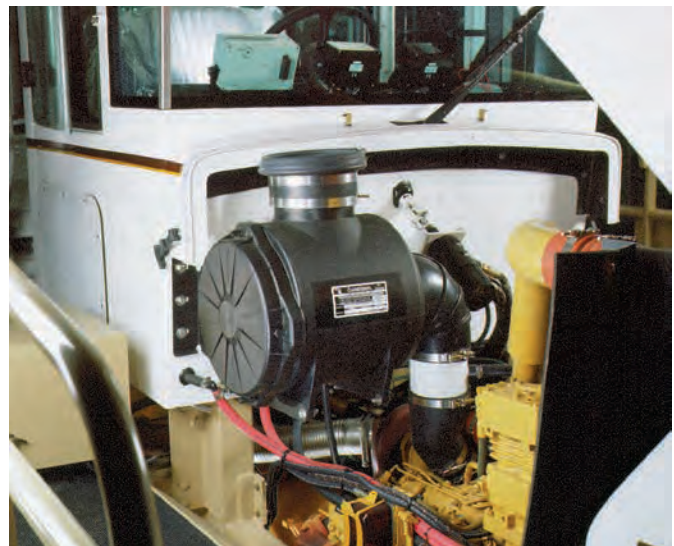

*The EPG Air Cleaner, which fits neatly under the hood, has RadialSeal™ Sealing Technology that delivers a reliable seal in rugged environments and quick filter change-out.*



## Provides up to 1325 cfm Airflow per Air Cleaner

### Applications

- Provides up to 1325 cfm airflow per air cleaner — double airflow to engine by using two units
- Horizontal or vertical installation

### Ideal for

- On-highway vehicles
- Marine and offshore equipment
- Light construction vehicles
- Agricultural vehicles
- Compressors and generator sets

### Air Cleaner Features

- Durable plastic housing is corrosion-free and weighs less than metal air cleaners
- Very few service parts. Easy to service.
- No mounting bands required. Installs securely via molded-in mounting flange(s) with pre-drilled holes on the side of the housing.
- Available in three body diameters: 11" (279mm), 13" (330mm), 15" (381mm)
- Temperature tolerances:  
11" (279mm) dia: -40 °F to 220°F (-40 °C to 104 °C)  
13" (330mm) 15" (381mm) dia: -40 °F to 200 °F (-40 °C to 93 °C)

### Filter Features

- RadialSeal™ Sealing Technology ensures reliability, is easy to service and makes the filter self-centering, self-aligning and self-sealing
- All models can accommodate safety filter
- Donaldson Blue® high efficiency and extended service filters — which capture sub-micron contaminant such as soot and carbon — are available for some models (see service parts listing on page 71)



### The Better Alternative to Drain Holes

The Donaldson Vacuator™ Valve is an optional accessory for the EPG that expels water from the air cleaner **before** any reaches the filter — thereby extending filter life. Bare drain holes can clog or take in back splash, but the Vacuator™ Valve never does. The P525956 is a 1" (25mm) diameter model designed for over-highway applications.

### Installation is fast and easy:

1. Locate the lowest point of the air cleaner to allow proper drainage through Vacuator Valve.
2. Remove filter(s) before drilling.
3. Drill a 1" (25mm) hole centered at the lowest point of the air cleaner as shown in illustration. Remove debris from drilling.
4. Install Vacuator Valve (P525956) by pushing it into the hole.
5. Reinstall filter(s), reattach cover.

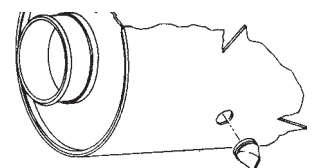



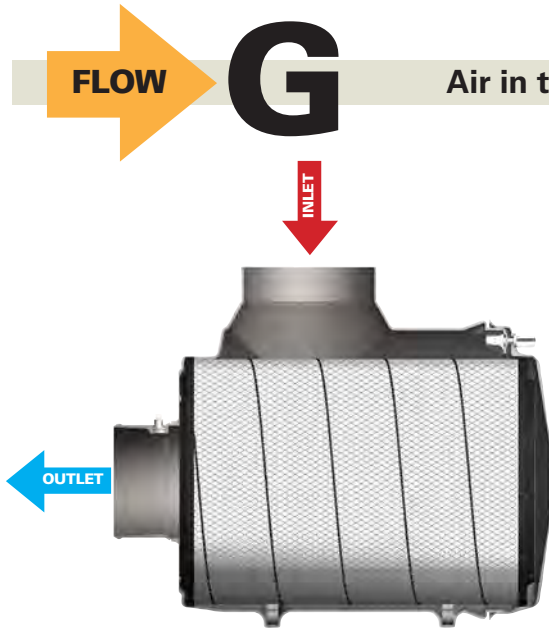

**Air in the Side, Out the End** (standard flow filters)

### Initial Airflow Restriction\*

Airflow	Air Cleaner Model
<b>MODELS WITH PRIMARY &amp; SAFETY FILTER</b>	
450 cfm @ 5.5" H <sub>2</sub> O	G110120
650 cfm @ 6" H <sub>2</sub> O	G130089
800 cfm @ 5.5" H <sub>2</sub> O	G150049
<b>MODELS WITH PRIMARY FILTER</b>	
625 cfm @ 5.5" H <sub>2</sub> O	G110119
950 cfm @ 10" H <sub>2</sub> O	G130079
1325 cfm @ 8" H <sub>2</sub> O	G150048

\*Results generated using laboratory testing pursuant to ISO5011. Actual performance during use may vary depending on multiple factors, including specific product configuration, external conditions and application.

## EPG Specification Illustrations

### 11" Models

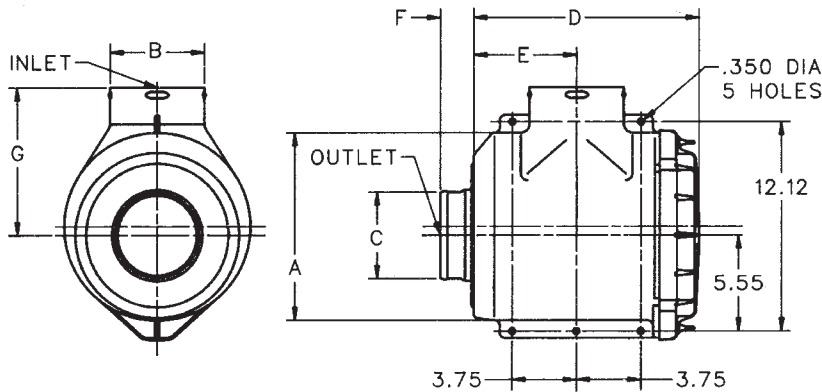

### 13" & 15" Models

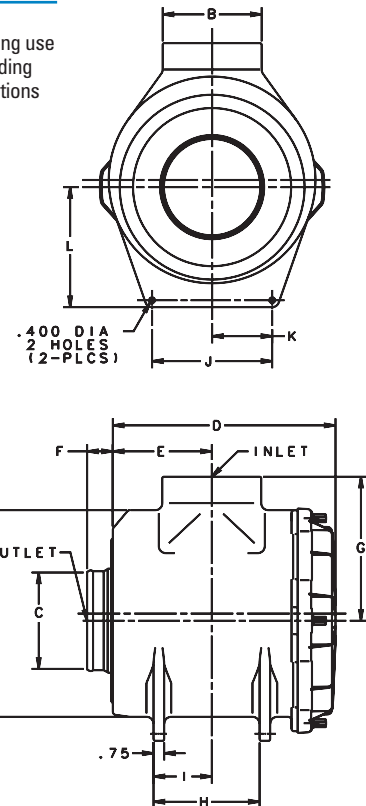

## EPG Specifications

Air Cleaner Model	Body Dia. (A)	Inlet Dia. (B)	Outlet Dia. (C)	Length (D)	(G)	Outlet Length (F)	(E)	(H)	(I)	(J)	(K)	(L)
G110119	10.86" 276mm	5.50" 140mm	5.00" 127mm	12.89" 327mm	8.56" 217mm	1.95" 50mm	6.00" 152mm	See drawing above for dimensions on 11" models				
G110120	10.86" 276mm	5.50" 140mm	5.00" 127mm	12.89" 327mm	8.56" 217mm	1.95" 50mm	6.00" 152mm	See drawing above for dimensions on 11" models				
G130079	12.62" 321mm	6.00" 152mm	5.00" 127mm	16.02" 407mm	9.51" 242mm	3.00" 76mm	5.66" 144mm	7.75" 197mm	2.00" 51mm	8.00" 203mm	4.00" 102mm	6.00" 152mm
G130089	12.62" 321mm	6.00" 152mm	5.00" 127mm	16.02" 407mm	9.51" 242mm	3.00" 76mm	5.66" 144mm	7.75" 197mm	2.00" 51mm	8.00" 203mm	4.00" 102mm	6.00" 152mm
G150048	14.62" 371mm	7.00" 178mm	7.00" 178mm	15.75" 400mm	10.19" 259mm	1.82" 46mm	7.00" 178mm	7.50" 191mm	4.12" 105mm	8.50" 216mm	4.25" 108mm	8.00" 203mm
G150049	14.62" 371mm	7.00" 178mm	7.00" 178mm	15.75" 400mm	10.19" 259mm	1.82" 46mm	7.00" 178mm	7.50" 191mm	4.12" 105mm	8.50" 216mm	4.25" 108mm	8.00" 203mm

## EPG Service Parts & Accessories

### G110119 EPG

Cover.....	P529151
Elbow, 45°.....	P109021
Elbow, 90°.....	P107844
Elbow, 90° reducing.....	P143895
Fastener kit.....	X006452
<b>Filter, primary-Donaldson Blue®... DBA5067</b>	
Filter, primary - SM.....	P527484 .....3
Filter, safety.....	P527680 .....4
Hump hose.....	P105610
Informer™ indicator 25" H <sub>2</sub> O.....	X002277
Inlet hood, plastic.....	H000604
Outlet band clamp.....	P148345
Thumb screw.....	P527435
Vacuator™ Valve.....	P525956

### G110120 EPG

Cover.....	P529151
Elbow, 45°.....	P109021
Elbow, 90°.....	P107844
Elbow, 90° reducing.....	P143895
Fastener kit.....	X006452
<b>Filter, primary-Donaldson Blue®... DBA5067</b>	
Filter, primary - SM.....	P527484 .....3
Filter, safety.....	P527680 .....3
Hump hose.....	P105610
Informer™ indicator 25" H <sub>2</sub> O.....	X002277
Inlet hood, plastic.....	H000604
Outlet band clamp.....	P148345
Thumb screw.....	P527435
Vacuator™ Valve.....	P525956

### G130079 EPG

Cover.....	P533916
Elbow, 45°.....	P109021
Elbow, 90°.....	P107844
Elbow, 90° reducing.....	P143895
Fastener kit.....	X006452
Filter, primary - SM.....	P533930 .....3
<b>Filter, primary-Donaldson Blue®... DBA5109</b>	
Filter, safety.....	P533890 .....4
Hump hose.....	P105610
Informer™ indicator 25" H <sub>2</sub> O.....	X002277
Inlet hood, metal.....	H000275
Inlet hood, plastic.....	H000606
Outlet band clamp.....	P148345
Thumb screw.....	P527435
Vacuator™ Valve.....	P525956

### G130089 EPG

Cover.....	P533916
Elbow, 45°.....	P109021
Elbow, 90°.....	P107844
Elbow, 90° reducing.....	P143895
Fastener kit.....	X006452
Filter, primary - SM.....	P533930 .....3
<b>Filter, primary-Donaldson Blue®... DBA5109</b>	
Filter, safety.....	P533890 .....3
Hump hose.....	P105610
Informer™ indicator 25" H <sub>2</sub> O.....	X002277
Inlet hood, metal.....	H000275
Inlet hood, plastic.....	H000606
Outlet band clamp.....	P148345
Thumb screw.....	P527435
Vacuator™ Valve.....	P525956

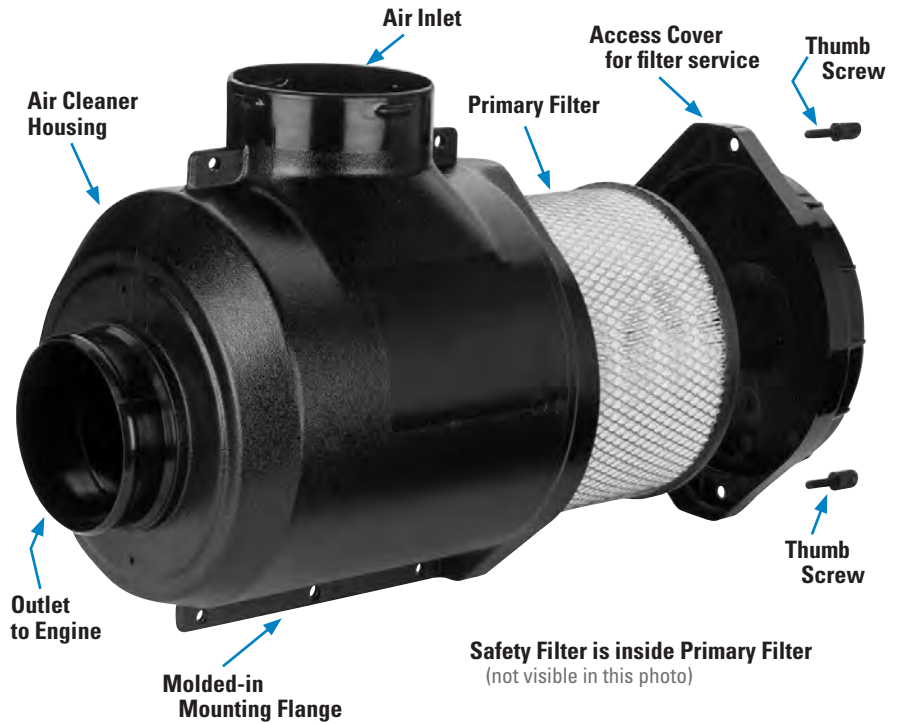

11" Model Shown

### G150048 EPG

Cover.....	P523096
Elbow, 45°.....	P105548
Elbow, 90°.....	P105536
Fastener kit.....	X006452
<b>Filter, primary-Donaldson Blue®... DBA5069</b>	
Filter, primary - SM.....	P527682 .....3
Filter, safety.....	P527683 .....4
Hump hose.....	P105613
Informer™ indicator 25" H <sub>2</sub> O.....	X002277
Inlet hood, metal.....	H000339
Inlet hood, plastic.....	H000607
Outlet band clamp.....	P148348
Thumb screw.....	P527435
Vacuator™ Valve.....	P525956



### G150049 EPG

Cover.....	P523096
Elbow, 45°.....	P105548
Elbow, 90°.....	P105536
Fastener kit.....	X006452
Filter, primary - SM.....	P527682 .....3
<b>Filter, primary-Donaldson Blue®... DBA5069</b>	
Filter, safety.....	P527683 .....3
Thumb screw.....	P527435
Hump hose.....	P105613
Informer™ indicator 25" H <sub>2</sub> O.....	X002277
Inlet hood, metal.....	H000339
Inlet hood, plastic.....	H000607
Outlet band clamp.....	P148348
Vacuator™ Valve.....	P525956

**NOTES:**

- 3 = Shipped with air cleaner initially
- 4 = Safety filter is designed to fit this air cleaner, but was not originally shipped with it (note that adding a safety filter will decrease the maximum airflow throughput)

SM= Scheduled Maintenance  
Donaldson Blue® = High Efficiency, Extended Service



This servicing information is provided as a best practices guide. It is not intended to replace or supersede the service instructions supplied by your engine or vehicle manufacturer.

### 1 Check the Restriction

Measure the restriction of the air cleaner with a Donaldson filter service indicator, service gauge or water manometer. Use the restriction tap provided on the air cleaner or at the transfer pipe. Replace the filter only when the restriction level has reached the maximum recommended by the engine or equipment manufacturer or on a regular service schedule.

### 2 Remove the Filter

Unfasten or unlatch the service cover. The RadialSeal™ filter fits tightly over the outlet tube to create the critical seal, so there will be some initial resistance, similar to breaking the seal on a jar. Gently move the end of the filter back and forth to break the seal. Rotate while pulling the filter straight out. Avoid knocking the filter against the housing.



### 3 Clean Out the Vacuator™ Valve

Remove the Vacuator Valve and clean out any dust found in the drop tube. Reinstall Vacuator Valve or replace if found worn or damaged. If your air cleaner is equipped with a Vacuator Valve, visually check and physically squeeze it.



Make sure the valve is flexible and not inverted, damaged or plugged. Replace it if damaged or if it looks like any of these images. A damaged or missing Vacuator™ Valve will disrupt the designed flow of air through the air cleaner.

### 4 Inspect the Old Filter

Inspect the old filter for any signs of leaks. A streak of dust on the clean side of the filter is a telltale sign. Eliminate any source of air leaks before installing the new primary filter.

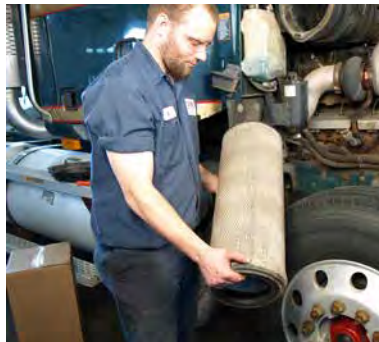

### 5 Visually Inspect the Safety Filter

If your air cleaner has a safety filter, do a visual inspection for damage. Verify that the safety filter is properly seated in the housing. Do not remove the safety filter unless it is damaged or due for replacement. The safety filter should be replaced every three primary filter changes. When you remove the safety filter, replace it immediately or make sure you cover the air cleaner outlet tube to avoid admitting any contaminant.

## 6 Clean Both Surfaces of the Outlet Tube

Use a clean damp cloth to wipe the filter sealing surface and the inside of the outlet tube. Contaminant on the sealing surface could hinder an effective seal and cause leakage.



## 7 Inspect the New Filter

Visually inspect the new filter, paying special attention to the sealing area which is inside the open end.

As you inspect the filter's RadialSeal take care not to wipe the sealing surface. The factory has placed a dry lubricant on the seal which aids in installation and removal. NEVER install a damaged filter.



## 8 Insert the New Filter Properly

If you're servicing the safety filter at this change-out, carefully seat it into position before installing the primary filter. Seat the filter by hand, making certain it is completely inserted into the air cleaner housing before securing the cover in place. To complete a tight seal, apply pressure by hand at the outer rim of the filter, not the flexible center.

Never use the service cover to push the filter into place since no cover pressure is required to hold the seal. Using the cover to apply pressure could damage the housing and cover fasteners, and will void the warranty.

If the new filter is not fully in place, remove the cover and push the filter further into the air cleaner with hand pressure on the outer rim. The cover should then go on with no extra force. Then secure the service cover.



## 9 Check Connectors for a Tight Fit

Make sure restriction indicators are reset and in proper working order.

Verify that all mounting bands, clamps, bolts, and connections in the entire air cleaner system are tight.

Check for holes in piping and repair or replace as needed. Any leaks in the intake piping will admit dust directly to the engine.







## Cowl-Mounted Air Cleaner Superior Protection with RadialSeal™ Sealing Technology

Looking for a replacement to our older EBA cylindrical-shaped axial seal style air cleaner? Our ERA RadialSeal™ air cleaner series delivers a reliable filtration system for your engine and simplifies filter service.

### Applications

- Light dust, single-stage air cleaner
- Vertical installation, mounted on the side of the truck
- Primarily for on-highway trucks
- Can be installed on driver or passenger's side
- Allows up to 1350 cfm airflow throughput per air cleaner

(Mounting the unit directly to the engine is not recommended)

### Air Cleaner Features

- Black, corrosion and chemical resistant polymer paint retains its finish through all types of weather
- Available in 11" (279mm), 13" (330mm) and 15" (381mm) diameter sizes
- Order inlet hoods separately
- Double airflow throughput by using two air cleaners
- Vacuator™ Valve automatically expels moisture from bottom of housing

### Filter Features

- RadialSeal sealing technology — high tech resilient urethane ends that hold the filter firmly in place and maintain a tight, reliable seal — reduces the number of components and ensures reliability
- High efficiency, extended service, Donaldson Blue® filters are available on some models (see service parts list on page 76 for part numbers)

*Our older, classic EBA cowl-mounted air cleaner (shown on the right) has been replaced with our ERA Air Cleaner.*

*EBA replacement filters are still available through your local Donaldson outlet.*



*The ERA Style air cleaner has RadialSeal sealing technology and fewer access bolts to remove during service compared to our old EBA air cleaner design.*

*The exterior finish is glossy black, polymer paint.*

*Don't forget to protect the air cleaner from rain and exposure, by adding an inlet hood to the intake flange on the service cover. Pre-cleaner inlet hoods are featured in the accessories section.*



**FLOW**

**Air in the End, Out the Side** (reverse flow filters)

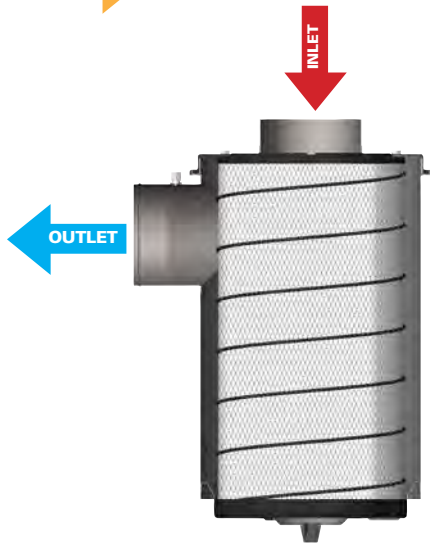

### When Selecting an Air Cleaner . . .

Determine the airflow requirements of your engine, then find the corresponding cfm airflow in the table at right. The restriction numbers (shown in inches of water) indicate the approximate initial restriction of each model air cleaner at that cfm. If there are two air cleaner models that fit your parameters, choosing the one with the lower restriction will provide longer filter service life. When calculating total initial restriction of the entire air intake system, include the restriction caused by ducting, elbows, and pre-cleaners. See pages 257-258 for ducting restriction estimates.

### Initial Airflow Restriction\*

CFM @ "H <sub>2</sub> O			Air Cleaner Model
6"	8"	10"	
<b>ERA AIR CLEANER</b>			
750	870	970	A110052
760	880	890	A130115
760	880	980	A150141
1045	1205	1350	A150138

\*Results generated using laboratory testing pursuant to ISO5011. Actual performance during use may vary depending on multiple factors, including specific product configuration, external conditions and application.

## ERA Specification Illustrations

Side and Top View

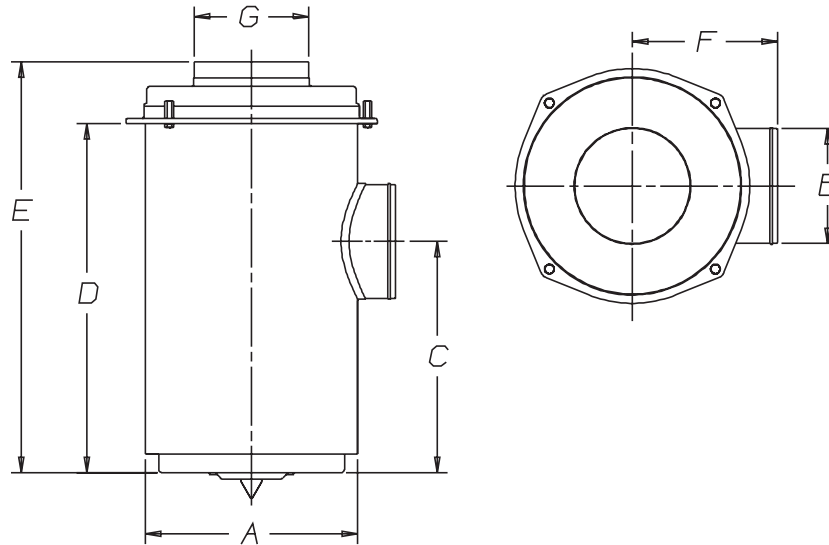

## ERA Specifications

Air Cleaner Models	Body Diameter (A)		Outlet Diameter (B)		Outlet Location (C)		Body Length (D)		Overall Length (E)		Outlet Location (F)		Inlet Dia. OD (G)		Service Clearance		Service Indicator Tap	Weight	
	in	mm	in	mm	in	mm	in	mm	in	mm	in	mm	in	mm	in	mm		lbs	kg
A110052	11.00	279	5.50	140	17.07	434	20.39	518	23.70	602	9.36	238	6.00	152	20.00	508	Yes	24	11
A130115	13.00	330	6.00	152	16.69	424	20.19	513	22.95	265	10.42	265	6.00	152	20.00	508	Yes	29	13
A150141	15.00	381	6.00	152	16.90	429	20.38	518	23.14	588	11.90	302	6.00	152	20.00	508	Yes	32	15
A150138	15.00	381	7.00	178	19.25	489	24.38	619	27.69	7.03	11.90	302	7.00	178	24.00	610	Yes	36	16



## ERA Service Parts & Accessories

### A110052 ERA

Bolt .....	P119463
Cover .....	P544744
Elbow, 45° .....	P105546
Elbow, 90° .....	P105534
Elbow, 90° reducing .....	P128990
Filter, primary-Donaldson Blue™ ...	DBA5148
Filter, primary - SM .....	P544741 .....3
Gasket, cover .....	P155211
Hump hose .....	P105611
Informer™ indicator 25" H <sub>2</sub> O .....	X002277
Inlet hood, metal .....	H000275
Inlet hood, plastic .....	H000606
Mounting band, black, metal .....	P004079
Nut, plastic .....	P119325
Outlet band clamp .....	P148346
Retaining ring .....	P129469
Vacuator™ Valve .....	P149099

### A130115 ERA

Bolt .....	P119463
Cover .....	P542475
Filter, primary - SM .....	P544950 .....3
Filter, primary-Donaldson Blue™ ...	DBA5149
Gasket, cover .....	P155264
Mounting band, black .....	P013722
Nut, plastic .....	P119325
Retaining ring .....	P129469
Vacuator™ Valve .....	P149099

### A150141 ERA

Bolt .....	P119463
Cover .....	P544827
Elbow, 45° .....	P105547
Elbow, 90° .....	P105535
Filter, primary-Donaldson Blue™ ...	DBA5151
Filter, primary - SM .....	P544243 .....3
Gasket, cover .....	P535559
Hump hose .....	P105612
Informer™ indicator 25" H <sub>2</sub> O .....	X002277
Inlet hood, metal .....	H000275
Inlet hood, plastic .....	H000606
Mounting band, metal, black .....	P016845
Nut, plastic .....	P119325
Outlet band clamp .....	P148347
Retaining ring .....	P129469
Vacuator™ Valve .....	P149099

### A150138 ERA

Bolt .....	P119463
Cover .....	P544238
Elbow, 45° .....	P105548
Elbow, 90° .....	P105536
Filter, primary-Donaldson Blue™ ...	DBA5150
Filter, primary - SM .....	P544301 .....3
Gasket, cover .....	P535559
Hump hose .....	P105613
Informer™ indicator 25" H <sub>2</sub> O .....	X002277
Inlet hood, metal .....	H000339
Inlet hood, plastic .....	H000607
Mounting band, black, metal .....	P016845
Nut, plastic .....	P119325
Outlet band clamp .....	P148348
Retaining ring .....	P129469
Vacuator™ Valve .....	P149099

Requires Inlet Hood — See Accessories section for choices and order separately.

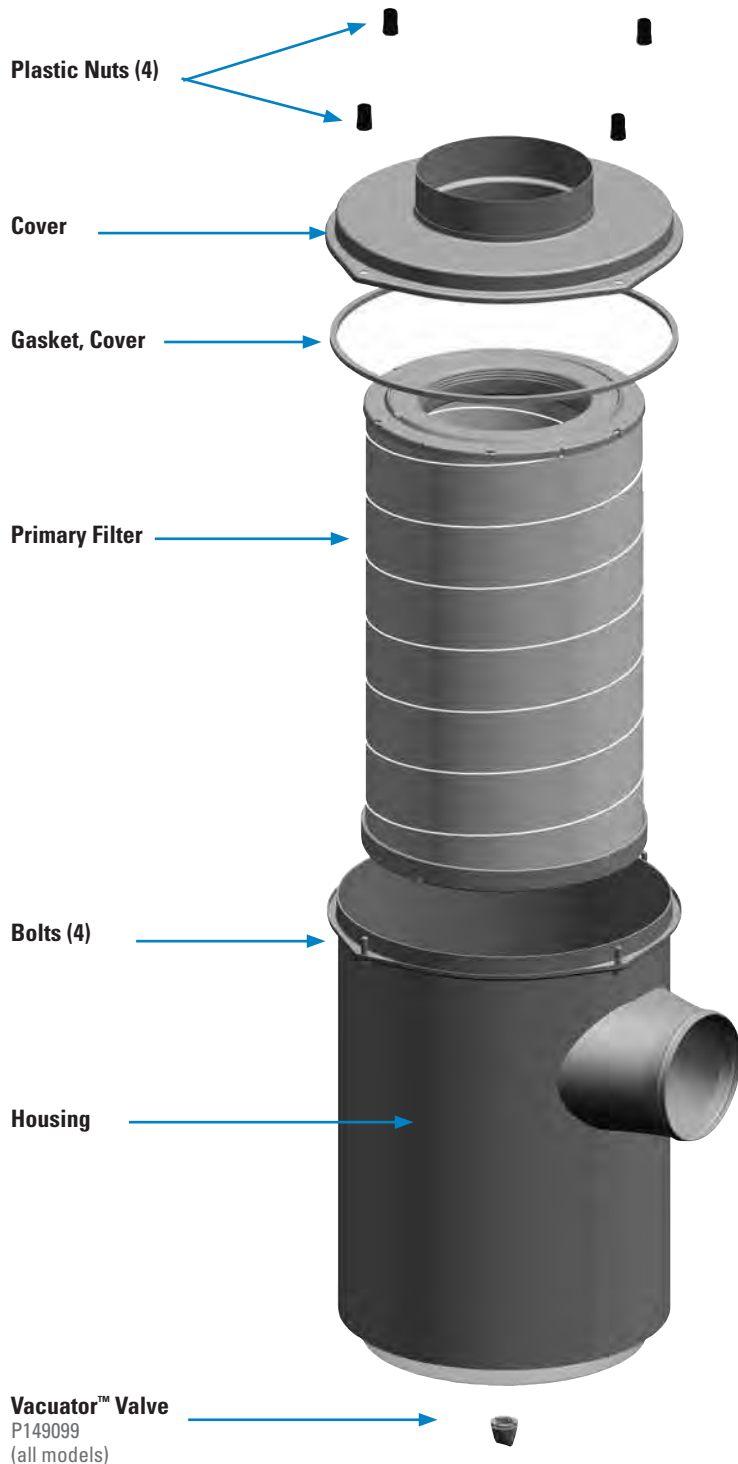

**NOTES:**  
3 = Shipped with air cleaner initially

SM = Scheduled Maintenance  
Donaldson Blue™ = High Efficiency, Extended Service

This servicing information is provided as a best practices guide. It is not intended to replace or supersede the service instructions supplied by your engine or vehicle manufacturer.

## 1 Check the Restriction

Replace the filter only when the restriction level has reached the maximum recommended by the engine or equipment manufacturer or on a regular service schedule. Restriction indicators, mounted on the air cleaner system are recommended for keeping an eye on restriction levels and indicating when servicing is due.



## 2 Remove the Filter

Unfasten or unlatch the service cover.

Because the filter fits tightly over the outlet tube to create the critical seal, there will be some initial resistance, similar to breaking the seal on a jar. Gently move the end of the filter back and forth to break the seal. Rotate while pulling the filter straight out. Avoid knocking the filter against the housing.



## 3 Check the Vacuator™ Valve

If your air cleaner is equipped with a Vacuator Valve, visually check and physically squeeze it. Make sure the valve is flexible and not inverted, damaged or plugged.

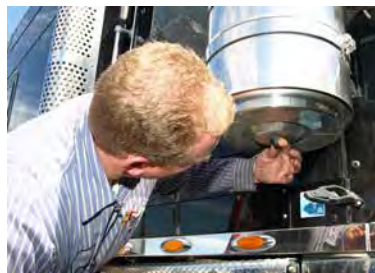

## 4 Inspect the Old Filter

Inspect the old filter for any signs of leaks. A streak of dust on the clean side of the filter is a telltale sign. Eliminate any source of air leaks before installing the new primary filter.



## 5 Clean Both Surfaces of the Outlet Tube

Use a clean damp cloth to wipe the filter sealing surface and the inside of the outlet tube. Contaminant on the sealing surface could hinder an effective seal and cause leakage.



*Continued on next page*





### 6

#### Inspect the New Filter

Visually inspect the new filter, paying special attention to the sealing area which is inside the open end. As you inspect the filter's RadialSeal™ take care not to wipe the sealing surface. The factory has placed a dry lubricant on the seal which aids in installation and removal.

NEVER install a damaged filter.



### 7

#### Insert the New Filter

Seat the filter by hand, making certain it is completely inserted into the air cleaner housing before securing the cover in place. To complete a tight seal, apply pressure by hand at the outer rim of the filter, not the flexible center. Never use the service cover to push the filter into place since no cover pressure is required to hold the seal.

Note that a cover gasket is usually supplied with ERA replacement filters. It is important that it be fitted at the same time as the new filter to ensure that the housing is airtight.

Using the cover to apply pressure could damage the housing and cover fasteners, and will void the warranty. If the new filter is not fully in place, remove the cover and push the filter further into the air cleaner with hand pressure on the outer rim. The cover should then go on with no extra force. Then, secure the service cover.



### 8

#### Check Connectors for a Tight Fit

Make sure restriction indicators are reset and in proper working order. Verify that all mounting bands, clamps, bolts, and connections in the entire air cleaner system are tight. Check for holes in piping and repair or replace as needed. Any leaks in the intake piping will admit dust directly to the engine.



**FLOW** **A** Air in the End, Out the Side

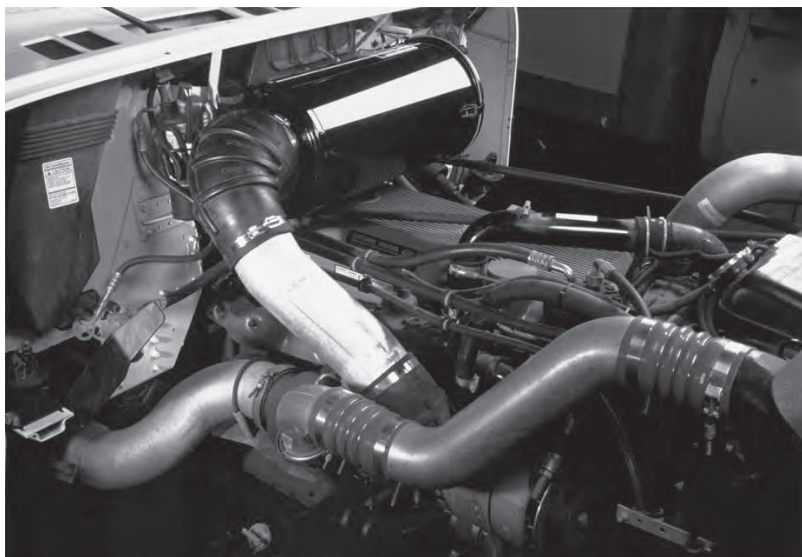
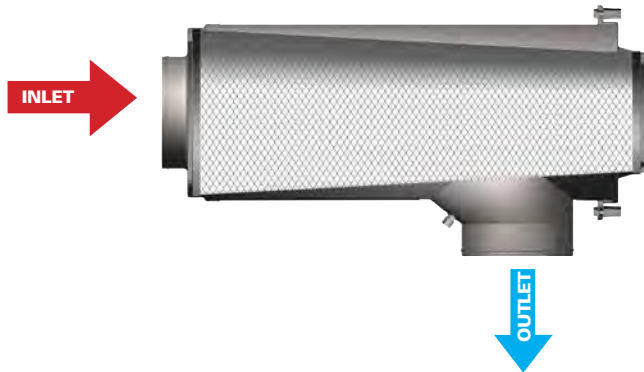

Because of the cone-shaped filter inside the housing, EBA Konepac™ is smaller in size compared to the ERA without sacrificing airflow. This allows trucks to meet width requirements in all states.

Picture of A112018 air cleaner with service cover on the opposite end of the inlet.



**Applications**

- Light-dust, single-stage air cleaner
- Typically mounted horizontally, underhood.

**When Selecting an Air Cleaner . . .**

Service parts for this axial style air cleaner may not be available due to newer filtration technology and housing designs. Donaldson now recommends RadialSeal™ style air cleaners for new applications.

If you do prefer this air cleaner style, please use the air cleaner selection steps outlined on the inside cover to determine which air cleaner is best for your engine.

**Initial Airflow Restriction\***

CFM @ "H <sub>2</sub> O			Air Cleaner Model
6"	8"	10"	
<b>STYLE KPI</b>			
1150	1300	1475	A112018
<b>STYLE KPII</b>			
875	1000	1130	A092037
1140	1300	1450	A112078
1400	1640	1850	A132001

\*Results generated using laboratory testing pursuant to ISO5011. Actual performance during use may vary depending on multiple factors, including specific product configuration, external conditions and application.

**Looking for the EBA Cylindrical models?**

The four models previously available have been replaced by a more reliable ERA RadialSeal style air cleaner design. The ERA models are a direct replacement to the older axial seal air cleaner models.

A110009 use A110052  
A150039 use A150141

A130045 use A130115  
A150128 use A150138



**EBA Konepac™ Specification Illustrations**

**Style Konepac I (KPI)**  
Service cover opposite the inlet end

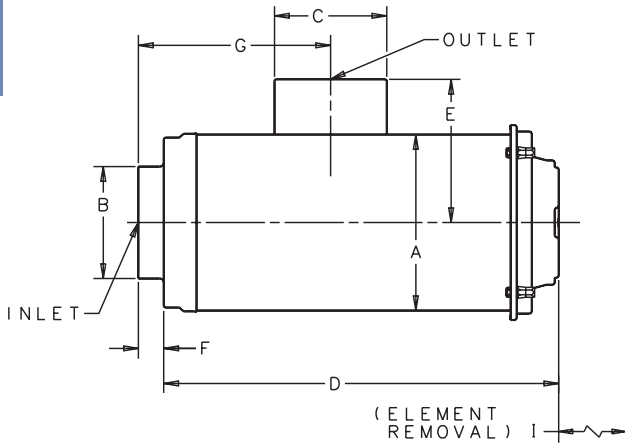

**Style Konepac II (KPII)**  
Service cover on inlet end

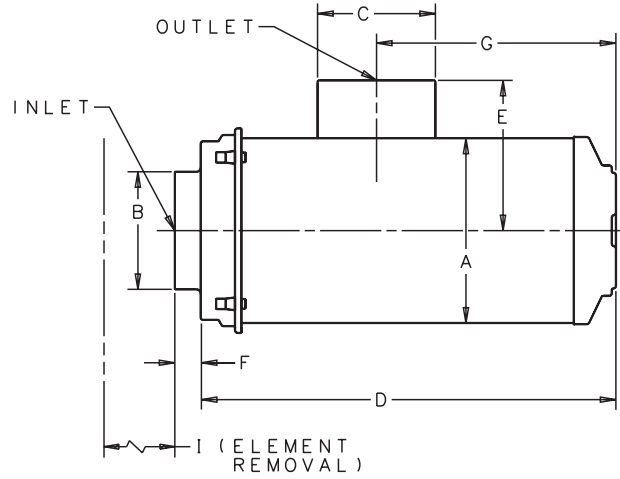

**EBA Konepac™ Specifications**

Air Cleaner Models	Body Diameter (A)		Inlet Diameter (B)		Outlet Diameter (C)		Length (D)		(E)		Inlet Length (F)		(G)		Service Clearance (I)		Service Indicator Tap	Weight	
	in	mm	in	mm	in	mm	in	mm	in	mm	in	mm	in	mm	in	mm		lbs	kg
<b>STYLE KPI</b>																			
A112018	11.00	279	7.00	178	7.00	178	28.62	727	8.95	227	1.58	40	22.20	564	28.00	711	Yes	39.0	17.8
<b>STYLE KPII</b>																			
A092037	9.00	229	6.00	152	6.00	152	28.63	727	7.85	199	1.18	30	10.00	443	27.62	702	Yes	21.5	9.5
A112078	11.00	279	7.00	178	7.00	178	28.67	728	8.95	227	1.58	40	8.00	203	28.00	711	Yes	30.0	13.6
A132001	13.00	330	8.00	203	8.00	203	28.59	726	10.00	254	2.38	60	7.50	191	28.00	711	No	42.0	19.0

**EBA Konepac Service Parts & Accessories**  
(KPII style shown)

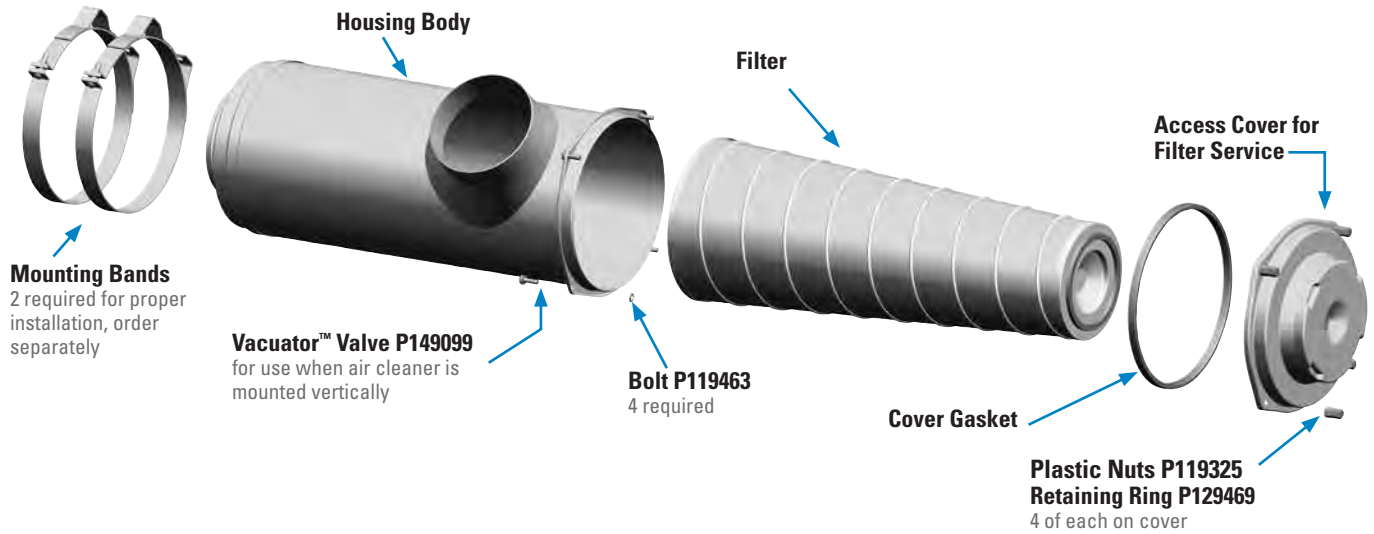

A092037	Style KPII	
Elbow, 45°		P105547
Elbow, 90°		P105535
Filter, primary		P140822
Filter, primary-Donaldson Blue®	... DBA5025	
Filter, primary treated		P129472 .....1,3
Gasket, cover		P120597
Hump hose		P105612
Informer™ indicator 25" H <sub>2</sub> O		X002277
Inlet hood, metal		H000275
Inlet hood, plastic		H000606
Mounting bands, metal		P004073
Nut, plastic		P119325
Outlet band clamp		P148347
Retaining ring		P129469
Vacuator™ Valve		P149099

A112078	EBA KPII	
Elbow, 45°		P105548
Elbow, 90°		P105536
Filter, primary		P151097
Filter, primary-Donaldson Blue®	... DBA5024	
Filter, primary treated		P129396 .....1,3
Gasket, cover		P155211
Hump hose		P105613
Informer™ indicator 25" H <sub>2</sub> O		X002277
Inlet hood, metal		H000339
Inlet hood, plastic		H000607
Mounting band, metal		P004079 .....2
Nut, plastic		P119325
Outlet band clamp		P148348
Retaining ring		P129469
Vacuator™ Valve		P149099

A112018	EBA KPI	
Elbow, 45°		P105548
Elbow, 90°		P105536
Filter, primary		P151097 .....3
Filter, primary-Donaldson Blue®	... DBA5024	
Filter, primary treated		P129396 .....1
Gasket, cover		P155211
Hump hose		P105613
Informer™ indicator 25" H <sub>2</sub> O		X002277
Inlet hood, metal		H000339
Inlet hood, plastic		H000607
Mounting band, metal		P004079 .....2
Nut, plastic		P119325
Outlet band clamp		P148348
Retaining ring		P129469
Vacuator™ Valve		P149099

A132001	EBA KPII	
Elbow, 45°		P112606
Elbow, 90°		P112605
Filter, primary		P141228 .....3
Filter, primary-Donaldson Blue®	... DBA5026	
Gasket, cover		P155264
Hump hose		P112608
Informer™ indicator 25" H <sub>2</sub> O		X002277
Inlet hood, plastic		H001053
Mounting band, metal		P013722 .....2
Nut, plastic		P119325
Outlet band clamp		P629991
Retaining ring		P129469
Vacuator™ Valve		P149099

**NOTES:**

- 1 = Filter is treated with chemical for carbon resistance and is not cleanable
- 2 = Two required for proper installation
- 3 = Shipped with air cleaner initially

Donaldson Blue® = High Efficiency, Extended Service





This servicing information is provided as a best practices guide. It is not intended to replace or supersede the service instructions supplied by your engine or vehicle manufacturer.

### 1 Check the Restriction

Measure the restriction of the air cleaner with a Donaldson filter service indicator, service gauge, or a water manometer.

Replace the filter only when the restriction level has reached the maximum recommended by the engine or equipment manufacturer or on a regular service schedule.

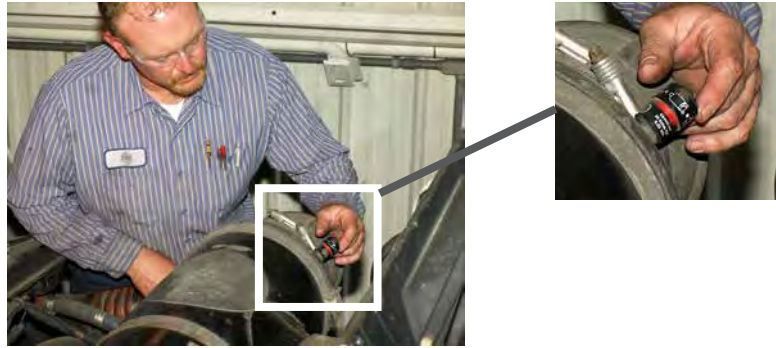

### 2 Gently Remove the Old Filter

Switch the engine off. Handle the dirty filter gently, until it is clear of the air cleaner housing. Accidental bumping will shake dirt loose inside the filter housing.



### 3 Clean the Inside of the Housing

Always clean the inside of the housing. Dirt left in the air cleaner housing can potentially damage your engine.

Use a clean, damp cloth to wipe every surface clean. Ensure that the outlet tube sealing area is clean and undamaged.



### 4 Check the Inside Visually Before Installing the Filter

Always clean the gasket sealing surface. An improper gasket seal is one of the most common causes of engine contamination. Make sure that all hardened dirt ridges are completely removed, both on the bottom and top of the air cleaner housing.

Check for uneven dirt patterns. Your old filter has valuable clues to dust leakage or gasket sealing problems. A pattern on the filter's clean side is a sign that the old filter was not firmly sealed or that a dust leak exists. Identify the cause of that leak and rectify it before installing a new filter.



## 5 Inspect the New Filter Before Installation

Check the new filter, but don't install it if it appears damaged. Check that the gasket is easily compressible and springs back promptly when finger pressure is released.



## 6 Install the New Filter

It is important to change the new supplied cover gasket with each filter service. Ensure that the filter is the correct size for the housing and install the filter, making sure the gasket seats evenly for a perfect seal. Without a proper seal, dirty air can by-pass the filter.



## 7 Ensure Air-tight Fit on All Connections and Ducts

Check that all clamps and flange joints are tight, as well as the air cleaner mounting bands. Attend to any leaks immediately to avoid dirt directly entering your engine. If the vehicle is fitted with air brakes, it is important to check the clean air supply hose which feeds the air brake compressor.







## High Airflow in Compact Size for Horizontal Installation

### Upgrade Path

To upgrade, consider the Donaldson EPG air cleaner or PSD air cleaners that use newer filtration technologies.

### Applications

- Airflow range 775 to 1600 cfm airflow throughput per air cleaner
- Horizontal installation, side inlet
- Over-highway trucks: horizontal under hood or behind cab
- Buses: under hood

### Air Cleaner Features

- Relatively small air cleaner with high airflow
- Designed for horizontal installation with side inlet
- Housing is metal and coated with a corrosion and chemical resistant polymer paint
- Direct engine mounting is not recommended due to excessive engine vibration
- All models have service access cover opposite the outlet end of the air cleaner

### Filter Features

- Cone shaped filters, which we call Konepac, allow maximum media in a small package (one filter is shipped with each air cleaner)
- Other filter performance options, including Donaldson Blue® high efficiency, extended service filters, are available on some models (see service parts list on pages 86 and 87 for part numbers)



The latched service cover on the ECG Konepac allows for easy access to the filter for change out.



ECG Konepac with Latched Service Access  
**Left:** a standard media filter, which is available with either standard or carbon-resistant media. **Middle:** the ECG Konepac™ metal air cleaner housing. **Right:** an extended service filter



ECG Konepac with Perforated Inlet — an alternative to disposable style housings. You'll get the economy of replacing the filter instead of the entire unit each time. The perforated inlet on the side of this G112417 housing (middle) is the same as the disposable's, so conversion is direct and easy. **Left:** Extended service filter. **Right:** Filter designed for scheduled maintenance.



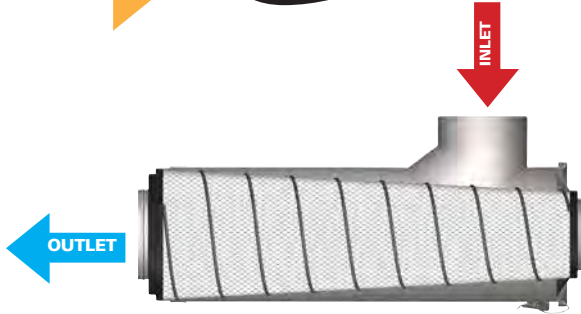

**When Selecting an Air Cleaner**

Service parts for this axial style air cleaner may not be available due to newer filtration technology and housing designs. Donaldson now recommends one of two other families — the EPG or PCD.

**Initial Airflow Restriction\***

CFM @ "H <sub>2</sub> O			Air Cleaner Model
6"	8"	10"	
<b>MODELS WITH BOLTED SERVICE ACCESS</b>			
775	880	1000	G092001
1100	1300	1425	G112001
1200	1400	1550	G132000
<b>MODELS WITH LATCHED SERVICE ACCESS</b>			
800	925	1040	G092401
1200	1400	1600	G112404
1200	1400	1600	G112417 <sup>1</sup>
1200	1400	1600	G112501
1200	1400	1600	G112504

\*Results generated using laboratory testing pursuant to ISO5011. Actual performance during use may vary depending on multiple factors, including specific product configuration, external conditions and application.

1 - No inlet tube, perforated inlet holes on side

**ECG Konepac™ Specification Illustrations**  
Bolted Service Access

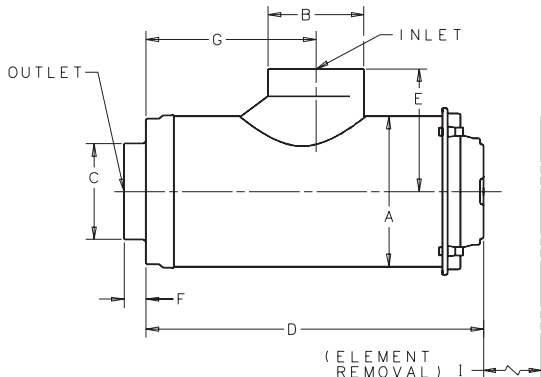

Latched Service Access

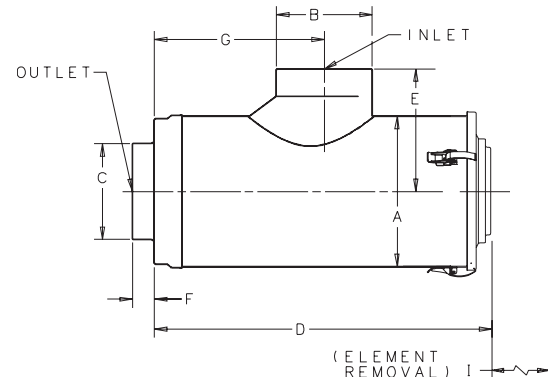

**ECG Konepac Specifications**

Air Cleaner Models	Body Diameter (A)		Inlet Diameter (B)		Outlet Diameter (C)		Overall Length (D)		(E)		Inlet Length (F)		(G)		Service Clearance		Service Indicator Tap	Weight	
	in	mm	in	mm	in	mm	in	mm	in	mm	in	mm	in	mm	in	mm		lbs	kg
<b>BOLTED SERVICE ACCESS</b>																			
G092001	9.00	229	6.00	152	6.00	152	28.63	727	7.85	199	1.18	30	18.63	473	27.62	702	No	30	14
G112001	11.00	279	7.00	178	7.00	178	28.62	727	8.95	227	1.58	40	20.62	524	27.00	686	No	38	17
G132000	13.00	330	7.00	178	7.00	178	24.59	625	9.54	242	2.38	60	18.25	464	27.62	702	No	36	16
<b>LATCHED SERVICE ACCESS</b>																			
G092401	9.00	229	6.00	152	6.00	152	28.70	729	7.86	200	1.18	30	21.75	553	27.62	702	No	30	14
G112404	11.00	279	7.00	178	7.00	178	22.70	577	8.97	228	2.00	51	12.32	313	22.00	559	Yes	33	15
G112417 <sup>1</sup>	11.00	279	--	--	7.00	178	28.70	729	--	--	2.00	51	15.11	384	28.00	711	Yes	30	14
G112501	11.00	279	7.00	178	7.00	178	28.30	719	8.97	228	2.00	51	21.22	539	28.00	711	Yes	23	10
G112504	11.00	279	7.00	178	7.00	178	22.30	566	8.97	228	2.00	51	12.32	313	22.00	559	Yes	20	9

1 - This model has no inlet tube; inlet consists of rectangular perforated holes on side of housing.

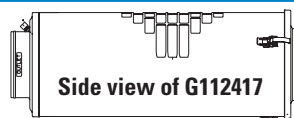





## ECG Konepac Service Parts

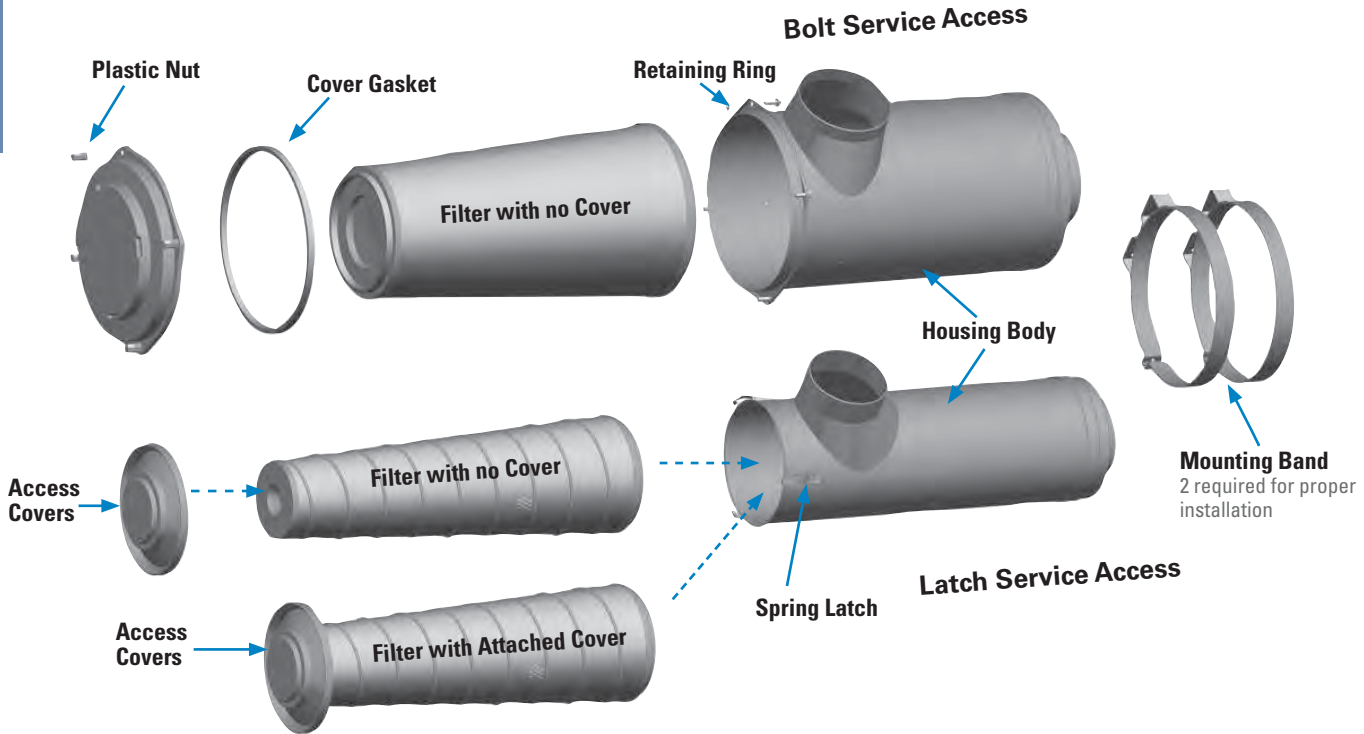

## ECG Konepac Service Parts & Accessories

### G092001 Bolted Service Cover

Elbow, 45° .....	P105547
Elbow, 90° .....	P105535
Filter, primary, no cover, treated... ..	P148044 ....1,3
Hump hose .....	P105612
Informer™ indicator 25" H <sub>2</sub> O .....	X002277
Inlet hood, metal.....	H000275
Inlet hood, plastic.....	H000606
Mounting band, metal .....	P004073 ....2
Nut, plastic .....	P119325
Outlet band clamp.....	P148347
Retaining ring.....	P129469

### G092401 Latch Service Cover

Elbow, 45° .....	P105547
Elbow, 90° .....	P105535
Filter, primary, attached cover.....	P150693 ....6
Filter, primary, no cover.....	P150692 ....3
Filter, primary, no cover, treated... ..	P148044 ....1
Hump hose .....	P105612
Informer™ indicator 25" H <sub>2</sub> O .....	X002277
Inlet hood, metal.....	H000275
Inlet hood, plastic.....	H000606
Mounting bands, metal .....	P004073
Outlet band clamp.....	P148347
Spring latch replacement kit.....	X006201

### G112001 Bolt Service Cover

Elbow, 45° .....	P105548
Elbow, 90° .....	P105536
Filter, primary, no cover, treated... ..	P148043 ....1,3
Gasket, cover.....	P155211
Hump hose .....	P105613
Informer™ indicator 25" H <sub>2</sub> O .....	X002277
Inlet hood, metal.....	H000339
Inlet hood, plastic.....	H000607
Kit.....	X006201
Mounting band, metal .....	P004079 ....2
Nut, plastic .....	P119325
Outlet band clamp.....	P148348
Retaining ring.....	P129469

### G112404 Latch Service Cover

Cover .....	P150862
Elbow, 45° .....	P105548
Elbow, 90° .....	P105536
Filter, primary, attached cover .....	P153551
Filter, primary, no cover, treated... ..	P154575 ....1,3
Gasket, cover.....	P536493
Hump hose .....	P105613
Informer™ indicator 25" H <sub>2</sub> O .....	X002277
Inlet hood, metal.....	H000339
Inlet hood, plastic.....	H000607
Mounting bands, metal .....	P004079
Outlet band clamp.....	P148348
Spring latch replacement kit.....	X006201



ECG style air cleaners have three cover latches that need to perform correctly to ensure the filter gasket is sealing properly. These latches should be checked for tightness and wear. To check

for tightness, close all three latches, then open and close them one at a time. There should be good tension and they should snap tightly when closed. If any latches seem loose or rattle, they should be replaced.

**G112417 Latch Service Cover**

Cover.....	P150862
Elbow, 45°.....	P105548
Elbow, 90°.....	P105536
Filter, primary, attached cover.....	P150695
<b>Filter, primary, attached cover</b>	
- Donaldson Blue®.....	DBA5047
Filter, primary, no cover.....	P150694.....3,5
<b>Filter, primary, no cover</b>	
- Donaldson Blue®.....	DBA5029
Gasket, cover.....	P536493
Hump hose.....	P105613
Informer™ indicator 25" H <sub>2</sub> O.....	X002277
Mounting bands, metal.....	P004079
Outlet band clamp.....	P148348
Spring latch replacement kit.....	X006201

**G112501 Latch Service Cover**

Elbow, 45°.....	P105548
Elbow, 90°.....	P105536
Filter, primary.....	P150694.....5
Filter, primary.....	P150695.....3,6
<b>Filter, primary, attached cover</b>	
- Donaldson Blue®.....	DBA5047
<b>Filter, primary, no cover</b>	
- Donaldson Blue®.....	DBA5029
Filter, primary treated.....	P148043.....1
Gasket, cover.....	P536493
Hump hose.....	P105613
Informer™ indicator 25" H <sub>2</sub> O.....	X002277
Inlet hood, metal.....	H000339
Inlet hood, plastic.....	H000607
Mounting bands, metal.....	P004079
Outlet band clamp.....	P148348
Spring latch replacement kit.....	X006201

**G112504 Latch Service Cover**

Elbow, 45°.....	P105548
Elbow, 90°.....	P105536
Filter, primary, attached cover.....	P153551.....6
<b>Filter, primary, attached cover</b>	
- Donaldson Blue®.....	DBA5053
Filter, primary, no cover, treated... ..	P154575.....1
Gasket, cover.....	P536493
Hump hose.....	P105613
Informer™ indicator 25" H <sub>2</sub> O.....	X002277
Inlet hood, metal.....	H000339
Inlet hood, plastic.....	H000607
Mounting bands, metal.....	P004079
Outlet band clamp.....	P148348
Spring latch replacement kit.....	X006201

**G132000 Bolt Service Cover**

Elbow, 45°.....	P105548
Elbow, 90°.....	P105536
Filter, primary, no cover.....	P142100.....3
<b>Filter, primary, no cover</b>	
- Donaldson Blue®.....	DBA5027
Gasket, cover.....	P120604
Hump hose.....	P105613
Informer™ indicator 25" H <sub>2</sub> O.....	X002277
Inlet hood, metal.....	H000339
Inlet hood, plastic.....	H000607
Mounting band, metal.....	P013722.....2
Nut, plastic.....	P119325
Outlet band clamp.....	P148348
Retaining ring.....	P129469

**NOTES:**

- 1 = Filter is treated with chemical for carbon resistance and is not cleanable
- 2 = Two required for proper installation
- 3 = Shipped with air cleaner initially
- 5 = Also requires access cover P150862
- 6 = Access cover is attached to filter

Donaldson Blue® = High Efficiency, Extended Service



This servicing information is provided as a best practices guide. It is not intended to replace or supersede the service instructions supplied by your engine or vehicle manufacturer.

### 1 Check the Restriction

Check the restriction of the air cleaner with a Donaldson filter service indicator, service gauge, or a water manometer.

Replace the filter only when the restriction level has reached the maximum recommended by the engine or equipment manufacturer or on a regular service schedule.

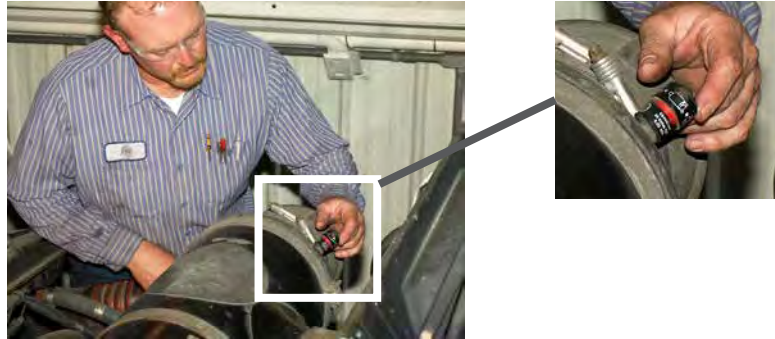

### 2 Gently Remove the Old Filter

Switch the engine off. Handle the dirty filter gently, until it is clear of the air cleaner housing. Accidental bumping will shake dirt loose inside the filter housing.



### 3 Clean the Inside of the Housing

Always clean the inside of the housing. Dirt left in the air cleaner housing can potentially damage your engine.

Use a clean, damp cloth to wipe every surface clean. Ensure that the outlet tube sealing area is clean and undamaged.



### 4 Visually Check the Inside Before Fitting the New Filter

Always clean the gasket sealing surface. An improper gasket seal is one of the most common causes of engine contamination. Make sure that all hardened dirt ridges are completely removed, both on the bottom and top of the air cleaner housing.

Check for uneven dirt patterns. Your old filter has valuable clues to dust leakage or gasket sealing problems. A pattern on the filter's clean side is a sign that the old filter was not firmly sealed or that a dust leak exists. Identify the cause of that leak and rectify it before installing a new filter.





## 5 Inspect the New Filter Before Installation

Check the new filter but don't install it if it appears damaged. Check that the gasket is easily compressible and springs back promptly when finger pressure is released.



## 6 Install the New Filter

It is important to change the new supplied cover gasket with each filter service. Ensure that the filter is the correct size for the housing and install the filter, making sure the gasket seats evenly for a perfect seal. Without a proper seal, dirty air can by-pass the filter.



## 7 Ensure Air-tight Fit on All Connections and Ducts

Check that all clamps and flange joints are tight, as well as the air cleaner mounting bands. Attend to any leaks immediately to avoid dirt entering your engine directly. If the vehicle is fitted with air brakes, it is important to check the clean air supply hose which feeds the air brake compressor.





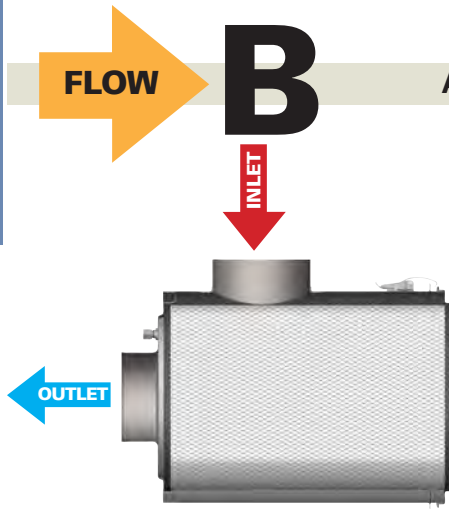

## Air in the Side, out the End (standard flow filters)

### When Selecting an Air Cleaner . . .

Determine the airflow requirements of your engine, then find the corresponding cfm airflow in the table below. The restriction numbers (shown in inches of water) indicate the approximate initial restriction of each model air cleaner at that cfm. If there are two air cleaner models that fit your parameters, choosing the one with the lower restriction will provide longer filter service life. When calculating total initial restriction of the entire air intake system, include the restriction caused by ducting, elbows, and pre-cleaners. See pages 257-258 for ducting restriction.



### Initial Airflow Restriction\*

CFM @ "H <sub>2</sub> O	Air Cleaner Model		
	6"	8"	10"
620	730	800	B120271
900	1050	1320	B140044
1360	1530	1640	B160049

\*Results generated using laboratory testing pursuant to ISO5011. Actual performance during use may vary depending on multiple factors, including specific product configuration, external conditions and application.

*When servicing the EBB, make sure to replace the cover gasket when changing filters.*

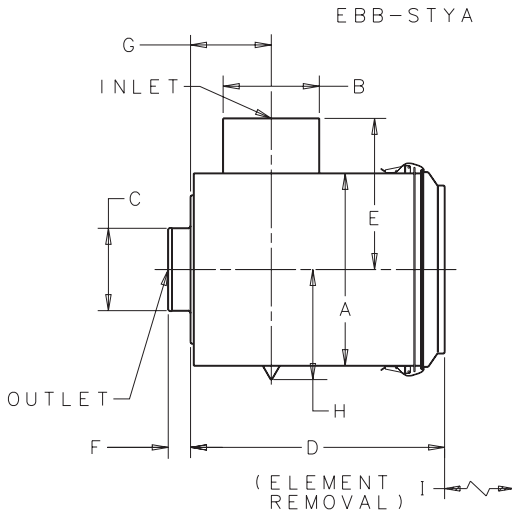

### EBB Specifications NOTE: All EBB Air Cleaners are tapped to accept a filter service indicator

Air Cleaner Models	Body Diameter (A)		Inlet Diameter (B)		Outlet Diameter (C)		Length (D)		(E)		Inlet Length (F)		(G)		(H)		Service Clearance (I)		Weight	
	in	mm	in	mm	in	mm	in	mm	in	mm	in	mm	in	mm	in	mm	in	mm	lbs	kg
B120271	11.81	300	5.50	140	5.00	127	16.42	417	7.64	194	2.00	51	5.80	147	--	--	16.0	406	16	7
B140044 <sup>1</sup>	14.00	356	7.00	178	6.00	152	18.50	470	10.90	277	1.62	41	5.88	149	8.00	203	17.5	445	19	8
B160049 <sup>2</sup>	16.00	406	8.00	203	7.00	178	18.75	476	12.91	328	2.50	64	8.84	225	--	--	18.0	457	35	16

1 - B140044 is only model with installed Vacuator™ Valve 2 - Access cover secured with bolts

**Service Parts & Accessories**

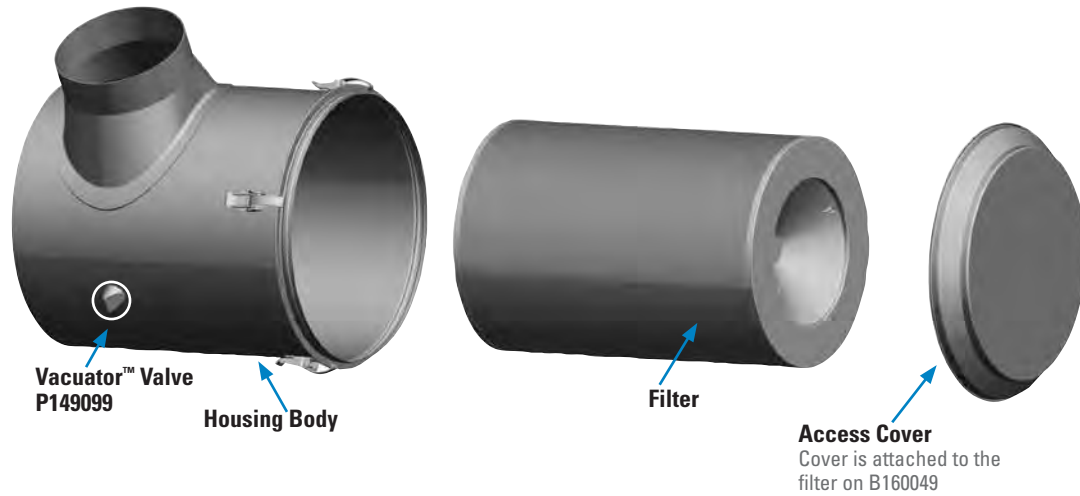

**B120271**

Elbow, 45° .....	P109021
Elbow, 90° .....	P107844
Elbow, 90° reducing .....	P143895
Filter, primary .....	P182028
Filter, primary - Donaldson Blue® .....	DBA5028
Filter, primary - SM .....	P181028 ....3
Hump hose .....	P105610
Informer™ indicator 25" H <sub>2</sub> O .....	X002277
Inlet hood, plastic .....	H000604
Mounting band, metal .....	H000349 ....2
Outlet band clamp .....	P148345

**B140044 EBB**

Elbow, 45° .....	P105547
Elbow, 90° .....	P105535
Filter, primary .....	P182015
Filter, primary - Donaldson Blue® .....	DBA5015
Filter, primary - SM .....	P181015 ....3
Hump hose .....	P105612
Informer™ indicator 25" H <sub>2</sub> O .....	X002277
Inlet hood, metal .....	H000339
Inlet hood, plastic .....	H000607
Mounting band, metal .....	H000350 ....2
Outlet band clamp .....	P148347

**B160049 EBB**

Elbow, 45° .....	P105548
Elbow, 90° .....	P105536
Filter, primary .....	P182099 ....3,6
Filter, primary - Donaldson Blue® .....	DBA5099
Filter, primary - SM .....	P181099 ....6
Hump hose .....	P105613
Informer™ indicator 25" H <sub>2</sub> O .....	X002277
Inlet hood, plastic .....	H001053
Mounting band, metal .....	H000351 ....2
Outlet band clamp .....	P148348

**NOTES:**

- 2 = Two required for proper installation
- 3 = Shipped with air cleaner initially
- 6 = Access cover is attached to filter

SM=Scheduled Maintenance  
Donaldson Blue® = High Efficiency, Extended Service



This servicing information is provided as a best practices guide. It is not intended to replace or supersede the service instructions supplied by your engine or vehicle manufacturer.

### 1 Check the Restriction

Check the restriction of the air cleaner with a Donaldson filter service indicator, service gauge, or a water manometer.

Replace the filter only when the restriction level has reached the maximum recommended by the engine or equipment manufacturer or on a regular service schedule.



### 2 Gently Remove the Old Filter

Switch the engine off. Handle the dirty filter gently, until it is clear of the air cleaner housing. Accidental bumping will shake dirt loose inside the filter housing.



### 3 Clean the Inside of the Housing

Always clean the inside of the housing. Dirt left in the air cleaner housing can potentially damage your engine.

Use a clean, damp cloth to wipe every surface clean. Ensure that the outlet tube sealing area is clean and undamaged.



### 4 Check the Inside Visually Before Installing the Filter

Always clean the gasket sealing surface. An improper gasket seal is one of the most common causes of engine contamination. Make sure that all hardened dirt ridges are completely removed, both on the bottom and top of the air cleaner housing.

Check for uneven dirt patterns. Your old filter has valuable clues to dust leakage or gasket sealing problems. A pattern on the filter's clean side is a sign that the old filter was not firmly sealed or that a dust leak exists. Identify the cause of that leak and rectify it before installing a new filter.





## 5 Inspect the New Filter Before Installation

Check the new filter but don't install it if it appears damaged. Check that the gasket is easily compressible and springs back promptly when finger pressure is released.

Note: Air cleaners with over center latches do not require gaskets.



## 6 Install the New Filter

It is important to change the newly supplied cover gasket, if included in shipment with filter, with each filter service. Ensure that the filter is the correct size for the housing and install the filter, making sure the gasket seats evenly for a perfect seal. Without a proper seal, dirty air can by-pass the filter.



## 7 Ensure Air-tight Fit on All Connections and Ducts

Check that all clamps, flange joints and air cleaner mounting bands are tight. Attend to any leaks immediately to avoid dirt entering your engine directly. If the vehicle is fitted with air brakes, it is important to check the clean air supply hose that feeds the air brake compressor.



### Reset the Indicator

If your system has a remote indicator, don't forget to reset it after filter service.



Total Filtration Solutions  
Vehicles • Engines • Equipment

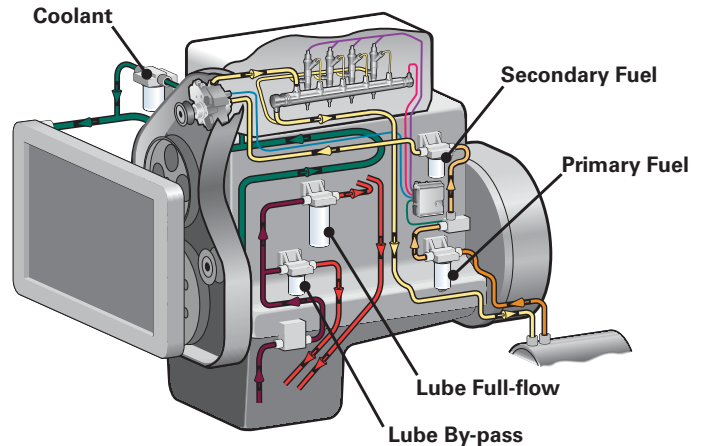
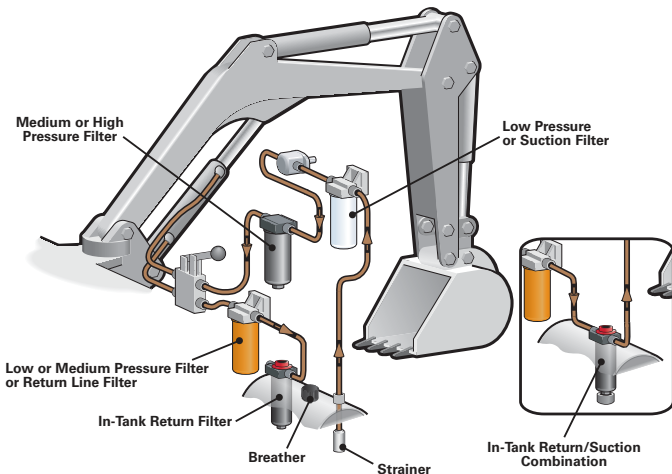
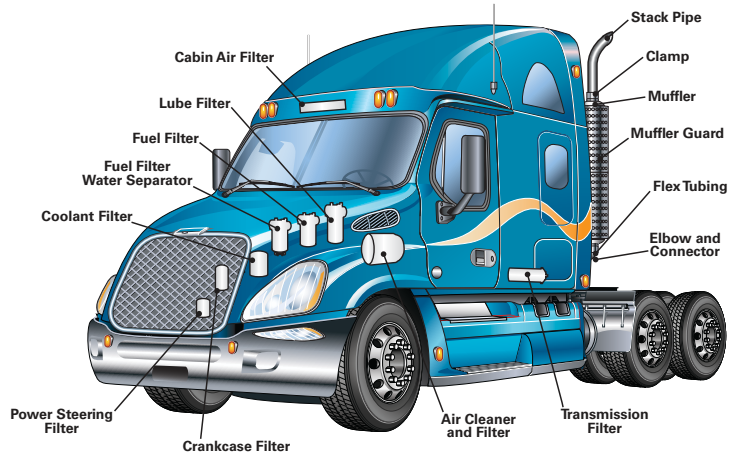
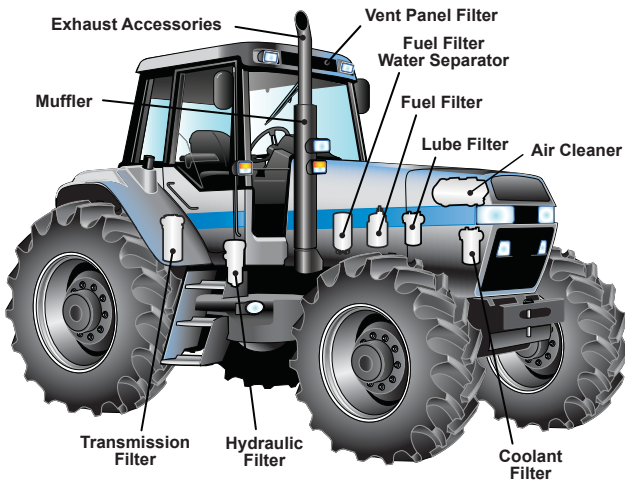
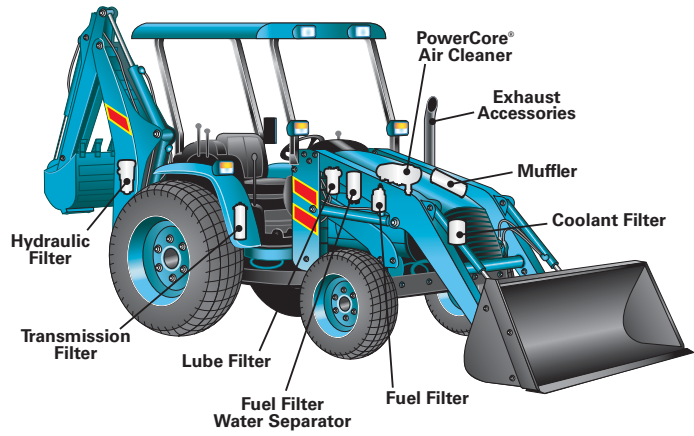
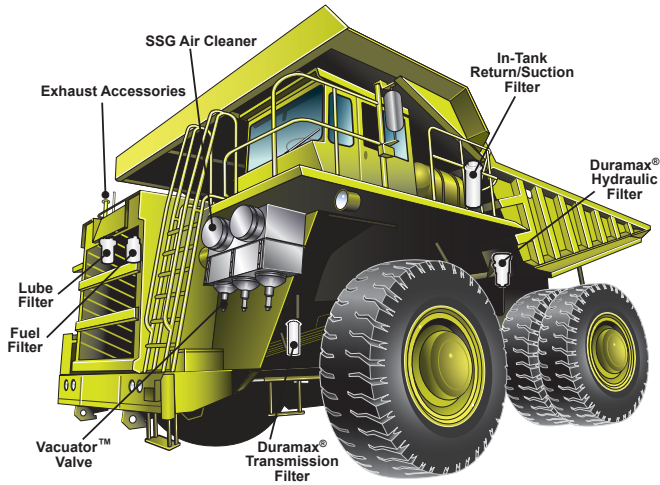

### Powerful Two-Stage Filtration for Diesel Engines Operating in Medium to Heavy Dust Conditions

The air cleaners featured in this section offer reliable two-stage filtration designs that have been proven by years of service in medium dust environments such as light construction, mining, agriculture, trucks, gen sets, compressors and industrial applications.



**If you're looking for a new two-stage air cleaner, check out the PowerCore® and PowerPleat™ Air cleaner sections first!**



**PowerCore**  
A Donaldson Filtration Technology  
**page 29**



**PowerPleat™**  
A Donaldson Filtration Technology  
**page 53**

### Section Index

- FKB .....96
  - Service Instructions..... 101
- XRB .....104
  - Service Instructions.....109
- FPG & FPG Alexin™ .....112
  - Service Instructions.....123
- FRG.....125
  - Service Instructions.....136
- FTG .....139
  - Service Instructions.....142
- FVG Cycloflow™ .....144
  - Service Instructions.....142

### Looking for FHG or FWG Air Cleaner Families?

Older FHG	FPG Model	--- FRG Model --- Style A    Style B	PowerPleat PSD
G052558	G065424	G052686	
G052559	G065424	G052686	
G052560	G057511	G052685	G052742
G052561	G057511	G052685	G052742
G065104	G065432	G065541	
G065113	G065432	G065541	
G065212	G065432	G065541	
G065360	G065432	G065551	
G080147	G070019	G080582	
G080195	G082528	G080585	

**Consult upgrade table in the Service Parts Listing/Upgrade section on page 239.**



## Smaller, Lightweight Alternative Two-Stage Air Cleaner Designed for horizontal installation

The FKB series is a family of two-stage air cleaners for medium dust conditions.

Compared to other air cleaner styles, this new air cleaner family delivers the performance of competitive larger air cleaners in a compact, rugged design.

With heavy-duty plastic construction and non-metal filters, the air cleaner is lighter, more efficient, and easier to install and replace than competing products.

Another key design feature is the built-in mounting brackets. There's no need for additional mounting support.

The two-stage design features a built-in pre-cleaner that separates up to 85% of airborne contaminants.



FKB air cleaners are smaller in diameter compared to competitive brands with similar airflow.

Cummins and Fleetguard are registered trademarks of Cummins, Inc. Mann+Hummel is a registered trademark of Mann+Hummel GMBH

The FKB's plastic housing and durable construction enables installation in all types of operating environments and temperature ranges from -40 °C to 82 °C, operating in medium dust conditions with engine air flow from 70 to 207 cfm (2 to 5.9 m<sup>3</sup>/min).

FKB air cleaners effectively reduce contaminants flowing into the air intake system, provide a high level of engine protection from harmful contaminants and increase engine performance and fuel efficiency.

The air cleaner models ship with both the primary and safety filters.



## Built-in Mounting Brackets and Filter Indicator Port Easy to service with non-metal filters

### Applications

- Off-road equipment operating in medium-dust conditions with engine airflow range of 70 to 207 cfm (2 to 5.9 m<sup>3</sup>/min)
- Installs horizontally. Mounting the air cleaner directly to the engine is not recommended; excessive engine vibration can cause premature air cleaner structural failure
- Sustained temperature tolerance: -40 °F to 180 °F / -40 °C to 82 °C. Do not install next to components that exceed the maximum temperature (180 °F / 82 °C); like a turbocharger, muffler, exhaust pipe or other high temperature component

### Air Cleaner Features

- Smaller in diameter compared to competitive brands with similar airflow
- Improved handling and maintenance — lighter and smaller, changing filters is a snap
- Product design includes:
  - primary filter
  - safety filter
  - filter service indicator port
- Improved filter disposal ease — no metal
- Cover latch position allows for minimum service clearance and eases filter service
- Built-in mounting brackets in air cleaner body eliminate need for mounting bands

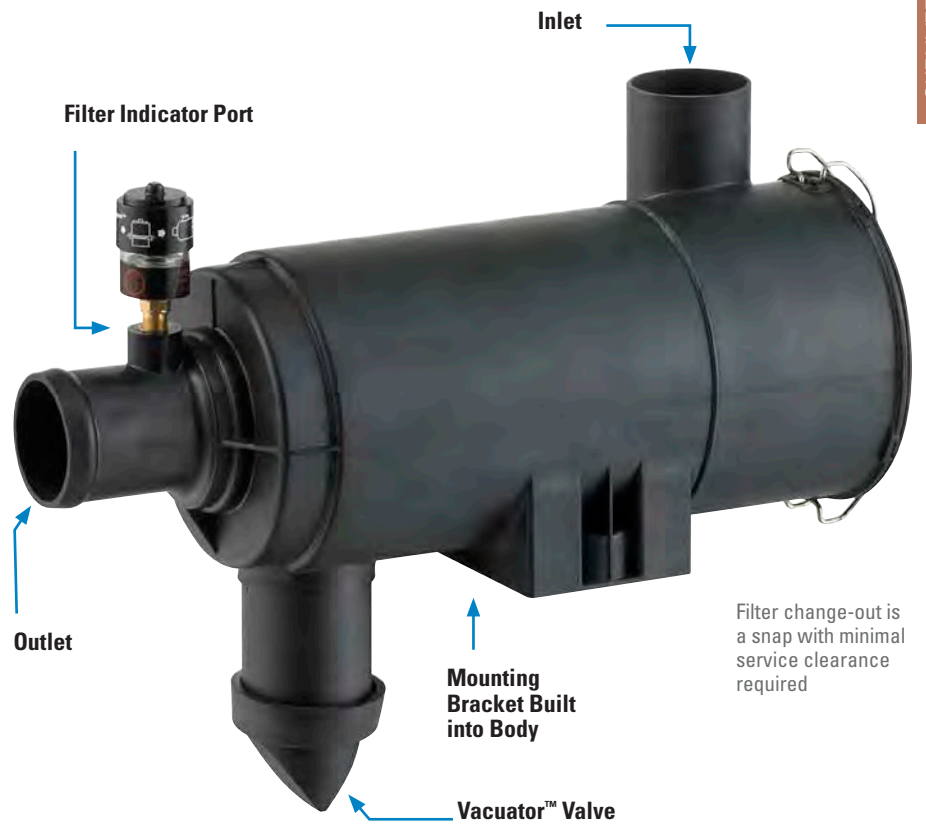

Filter change-out is a snap with minimal service clearance required

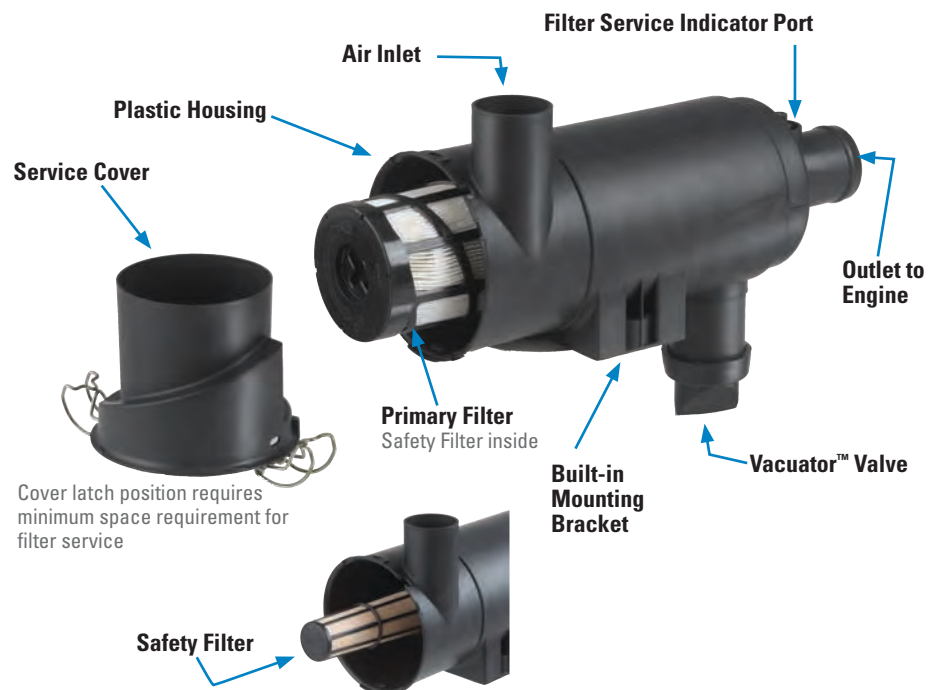

Cover latch position requires minimum space requirement for filter service



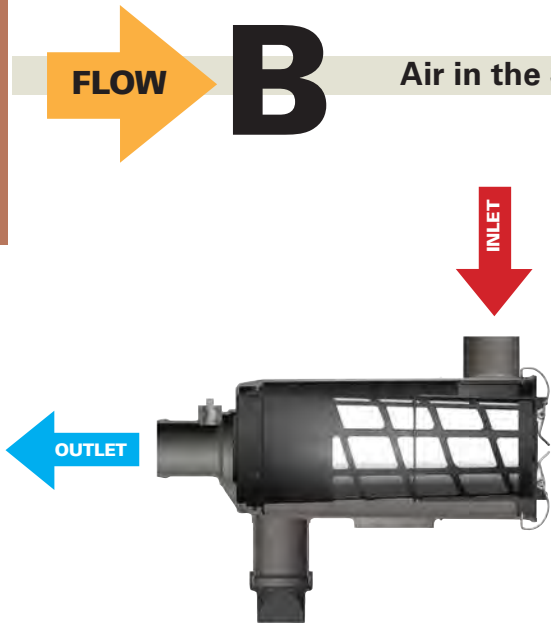

**Air in the Side, out the End** (standard flow filters)

### When spec'ing an Air Cleaner . . .

Determine the airflow requirements of your engine, then find the corresponding cfm airflow in the table at right. The restriction numbers (shown in inches of water) indicate the approximate initial restriction of each model air cleaner at that cfm. If there are two air cleaner models that fit your parameters, choosing the one with the lower restriction will provide longer filter service life. When calculating total initial restriction of the entire air intake system, include the restriction caused by ducting, elbows, pre-cleaners, etc. See pages 257-258 for ducting restriction estimates.

### Initial Airflow Restriction

CFM@ H <sub>2</sub> O			Air Cleaner Model
6"	8"	10"	
70	84	95	<b>B045008</b>
116	137	154	<b>B055006</b>
155	185	207	<b>B065045</b>

## FKB Air Cleaner Performance Curves (Restriction & Dust Capacity)\*

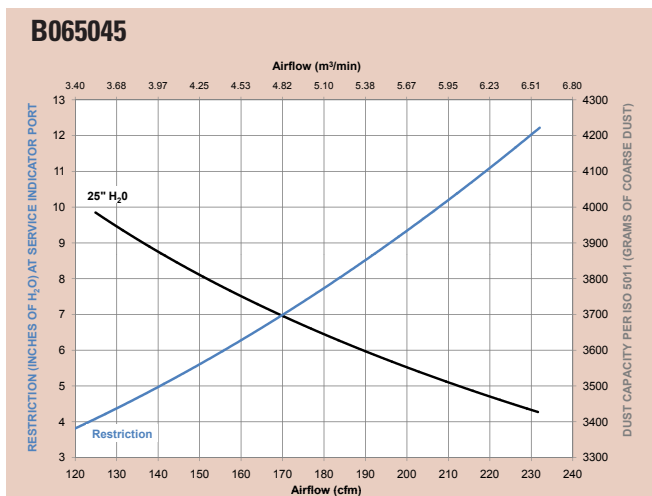
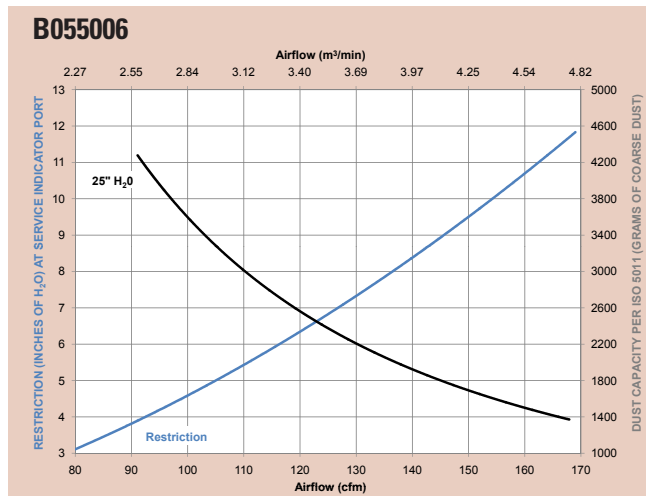
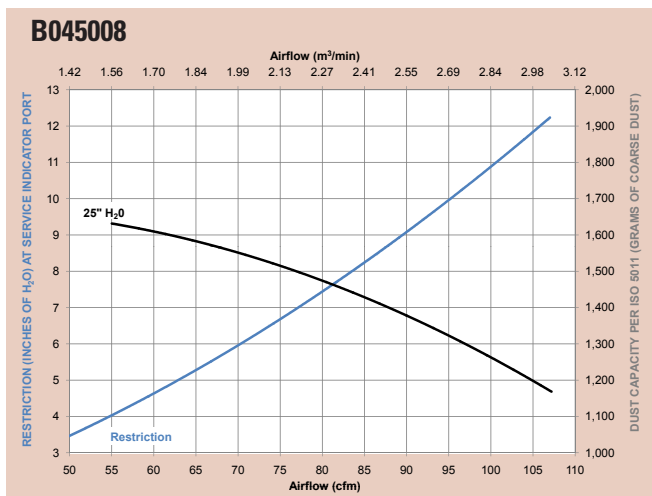

\*Results generated using laboratory testing pursuant to ISO5011. Actual performance during use may vary depending on multiple factors, including specific product configuration, external conditions and application.

**FKB Specification Illustrations**

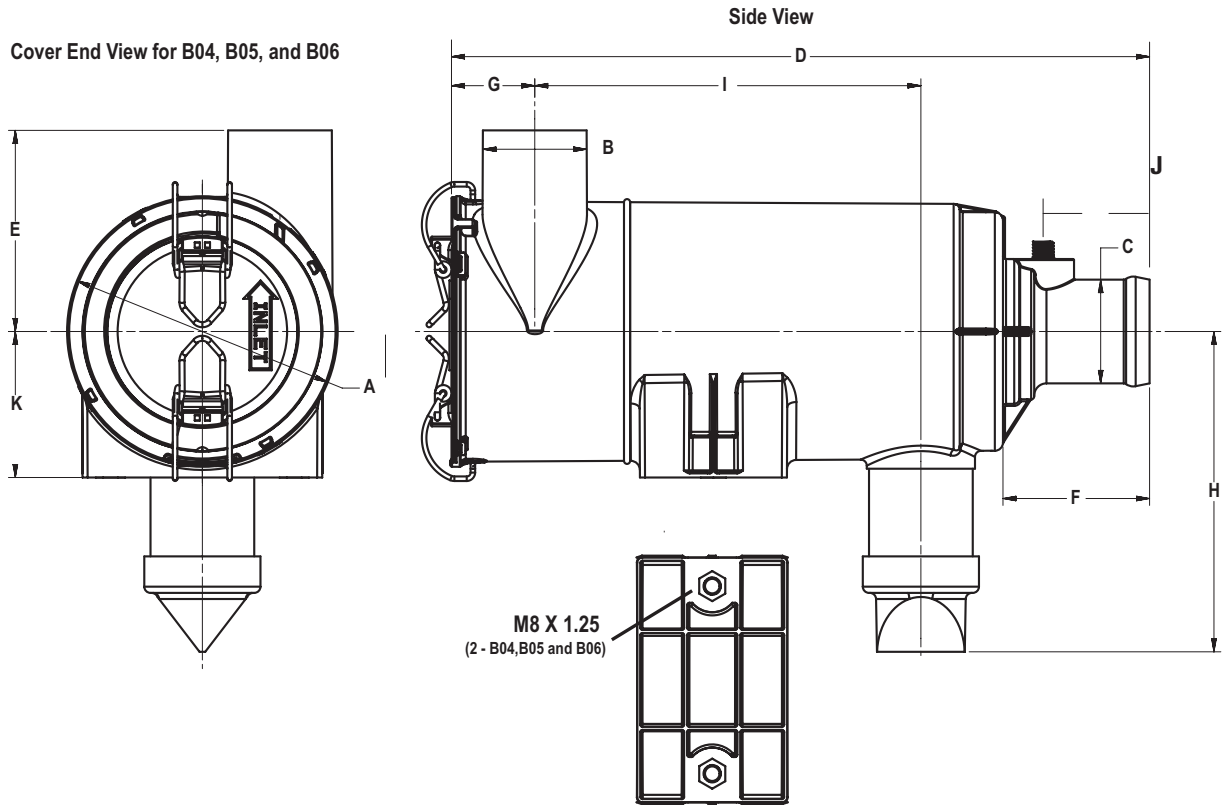

**FKB Specifications**

Air Cleaner Models	Body Dia. (A)	Inlet Dia. (B)	Outlet Dia. (C)	Housing Length (D)	Inlet Height (E)	Outlet Length (F)	Inlet Location (G)	Center Line to Valve (H)	Service Clear. (I)	Weight	Restr. Tap Loc. (J)	Mounting Bracket Height (K)
B045008	5.22" 133mm	2.00" 51mm	2.00" 51mm	13.46" 342mm	3.88" 99mm	2.83" 72mm	1.60" 41mm	6.18" 157mm	7.44" 189mm	2.1 lb 1.0 kg	2.02" 52mm	2.82" 72mm
B055006	5.97" 152mm	2.50" 64mm	2.50" 64mm	15.89" 404mm	3.88" 99mm	2.88" 73mm	1.93" 49mm	6.18" 157mm	9.61" 244mm	3.2 lb 1.4 kg	2.05" 52mm	3.03" 77mm
B065045	7.09" 180mm	3.00" 76mm	3.00" 76mm	16.06" 408mm	4.72" 120mm	2.87" 73mm	2.07" 53mm	7.41" 188mm	9.50" 241mm	3.7 lb 1.7 kg	2.05" 52mm	3.54" 90mm

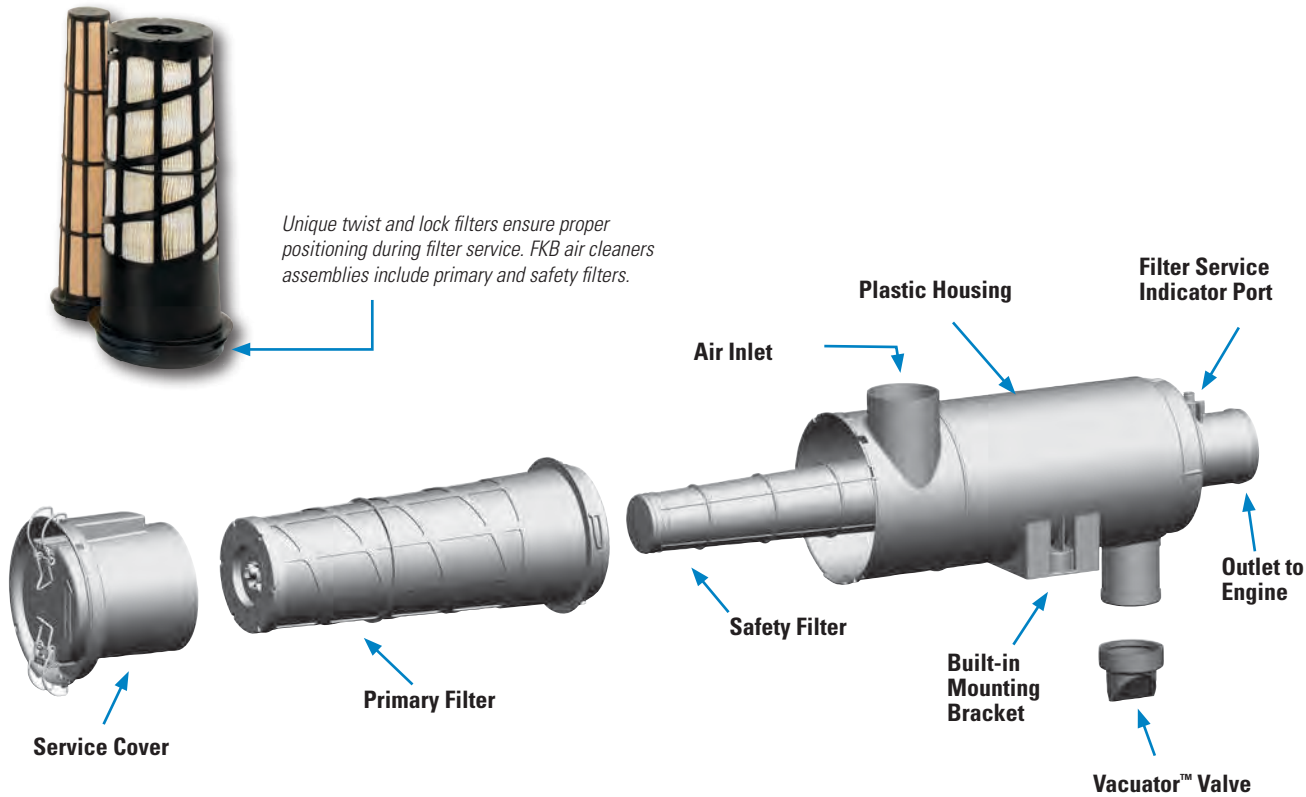

## FKB Service Parts & Accessories

B045008	FKB	B055006	FKB	B065045	FKB
Cover .....	P606497	Cover .....	P609219	Cover .....	P608592
Filter, primary .....	P604457 .....3	Filter, primary .....	P609218 .....3	Elbow, 45° .....	P105544
Filter, safety .....	P603729 .....3	Filter, safety .....	P602427 .....3	Elbow, 90° .....	P105532
Vacuator™ Valve .....	P158914	Vacuator™ Valve .....	P158914	Elbow, 90° reducing .....	P123462
Elbow, 45° .....	P105541	Elbow, 45° .....	P105543	Filter, primary .....	P609221 .....3
Elbow, 90° .....	P105529	Elbow, 90° .....	P105531	Filter, safety .....	P608599 .....3
Informer™ indicator 25" H <sub>2</sub> O .....	X002277	Informer™ indicator 25" H <sub>2</sub> O .....	X002277	Hump hose .....	P105608
Inlet hood, plastic .....	H001377	Inlet hood, plastic .....	H001378	Informer™ indicator 25" H <sub>2</sub> O .....	X002277
Outlet band clamp .....	P148337	Outlet band clamp .....	P148339	Inlet hood, plastic .....	H001379
				Outlet band clamp .....	P148341
				Vacuator™ Valve .....	P158914

**NOTES:**  
3 = Shipped with air cleaner initially

## Installation Recommendations

- Shut off your engine.
- Air cleaner orientation is horizontal, with the drop tube pointing down — within +/- 15°. For service clearance, allow the entire length of the filter for removal and 35mm for service cover latches.
- Mounting is M8 x 1.25, with a maximum torque of 15 ft•lb.
- Connections: Inlet/Outlet maximum torque 40 in•lb. Indicator port maximum torque 1.5 ft•lb.
- **Inlet accessory note:** The air cleaner housing can accommodate a plastic inlet hood or plastic TopSpin™ pre-cleaner, but not a metal pre-cleaner or accessory.

**This servicing information is provided as a best practices guide. It is not intended to replace or supersede the service instructions supplied by your engine or vehicle manufacturer.**

## 1 Check the Restriction

Measure the restriction of the air cleaner with a Donaldson filter service indicator, service gauge, or a water manometer. Replace the filter only when the restriction level has reached the maximum recommended by the engine or equipment manufacturer or on a regular service schedule.



## 2 Clean out the Vacuator™ Valve

Remove the Vacuator Valve and clean out any dust found in the drop tube. Reinstall Vacuator Valve or replace it if it is worn or damaged.



## 3 Remove the Primary Filter

Unlatch and remove the service cover on the FKB air cleaner.

To remove the primary filter, press and rotate the filter counter-clockwise until free. Then extract the primary filter by slowly pulling it out of the housing.



*Note: Avoid dislodging contaminant from the filter as it is removed from the air cleaner housing.*

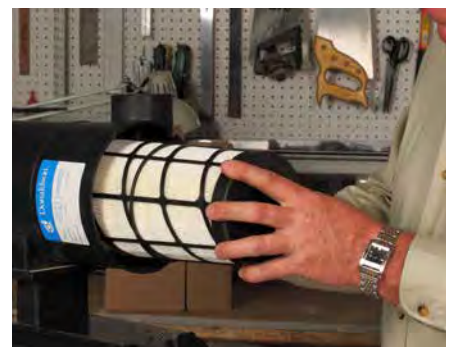

*Continued on next page*





### 4 Remove the Safety Filter or Liner

Next remove the safety filter (replace at every third primary filter change) or support liner by pulling it straight out. This allows necessary access to properly clean the primary filter's seal surface.

Inspect the seal surface and housing for any damage. Replace the complete air cleaner if damage is present.

It is not necessary to replace the support liner unless it is damaged. If you are reusing the safety filter keep it clean while servicing the housing to avoid contamination.



*Note: If a safety filter or liner is not present, check to see if it has attached itself to the inside of the primary filter during removal.*

*To properly service this small diameter air cleaner, you will need to remove the safety filter or liner upon each filter service.*

### 5 Clean the Inside Surface

Block the outlet tube of the air cleaner using a small dampened towel prior to cleaning the seal and locking surfaces to avoid contaminating the induction system.

With a clean damp cloth, thoroughly clean the inside surface of the housing, seal and lock surfaces.



*Note: Failure to clean the inside surface may cause contaminants to be introduced to the outlet tube or onto the seal area of the primary filter during reinstallation resulting in a leak for dirty air.*

### 6 Inspect the New Filters

Inspect the new primary and safety filters for any damage, voids, cuts, tears, or indentations in the media or urethane sealing surfaces.



### 7 Install the Safety Filter

Remove the dampened towel from the outlet tube that was used to protect the induction system during servicing. Install the safety filter or support liner by pressing it firmly in place until seated. When properly fitted, it should fit snugly inside the outlet tube.



## 8 Install the Primary Filter

Install the new primary filter by pressing and rotating the filter clockwise until fully fitted against the stop.

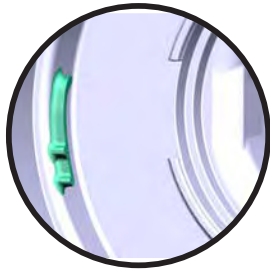

Close-up of Filter Stop

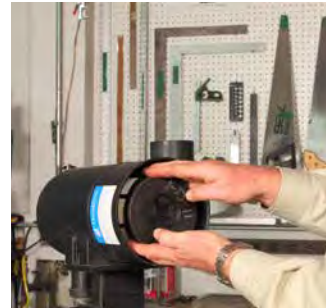

*Note: If you perform filter maintenance service on a schedule vs. using service indicators, you may want to write the service date on the filter end cap.*



## 9 Fasten the Service Cover

The "INLET" arrow on the cover should line up with the air cleaner inlet.

Do not force the cover onto the air cleaner. It should go on easily with no extra force.



Re-fasten the latches which secure the cover. Make sure that latches penetrate the slots in both the body and the cover.



*Note: If the cover does not fit flush to the body, the primary filter is not properly seated in the housing. Recheck the primary and safety filter installation following the proper installation procedure so they become fully seated.*

## 10 Reset the Filter Indicator and Inspect the Air Cleaner System

If your system has a restriction indicator, reset the device.

Inspect and torque all clamps, bolts and connections in the entire air intake system. Check for holes in piping, and repair if needed.







## Compact, RadialSeal™, Medium-Duty Air Cleaner Designed for Horizontal Installation



*Donaldson XRB air cleaners are built with Donaldson technologies.*

The XRB air cleaner family is smaller in size compared to competitive models with similar airflow operating ranges.

XRB air cleaners effectively reduce contaminants flowing into the air intake system, provide a high level of engine protection from harmful contaminants and increase engine performance and fuel efficiency.

The XRB's plastic housing and durable construction enables installation in all types of operating environments and temperature ranges from -40 °F to 180 °F / -40 °C to 82 °C, operating in medium-dust conditions with engine airflow from 265 to 630 cfm.

The B080080 has non-metal primary and safety filters. The primary filters for the B100127 and B120420 have metal outer liners. The air cleaner models ship with both the primary and safety filters.

Like our FKB and PSD models, these air cleaners feature built-in mounting brackets. There's no need for additional mounting support.



*Built-in mounting brackets on air cleaner body eliminate the need for mounting bands.*



*Cover latch position allows for minimum service clearance and eases filter service.*



*Air cleaners are equipped with the Donaldson Vacuator™ Valve.*

## Built-in Mounting Brackets and Filter Indicator Port Easy to Service with Non-metal Filters

### Applications

- On- and off-road equipment operating in medium-dust conditions with engine airflow range of 255 to 630 cfm (7.5 to 17.8 m<sup>3</sup>/min)
- Installs horizontally. Mounting the air cleaner directly to the engine is not recommended; excessive engine vibration can cause premature air cleaner structural failure.
- Sustained temperature tolerance: -40 °F to 180 °F / -40 °C to 82 °C. Do not install next to components that exceed the maximum temperature (180 °F / 82 °C) like a turbocharger, muffler, exhaust pipe or other high temperature component

### Air Cleaner Features

- Smaller in diameter compared to competitive brands with similar airflow
- Improved handling and maintenance — lighter and smaller, changing filters is a snap
- Product design includes:
  - primary filter
  - safety filter
  - filter service indicator port
- Cover latch position allows for minimum service clearance and eases filter service
- Built-in mounting brackets on air cleaner body eliminate the need for mounting bands

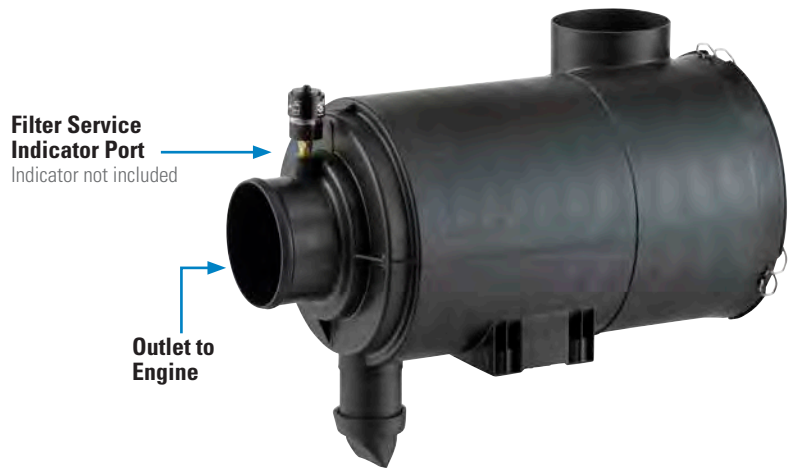
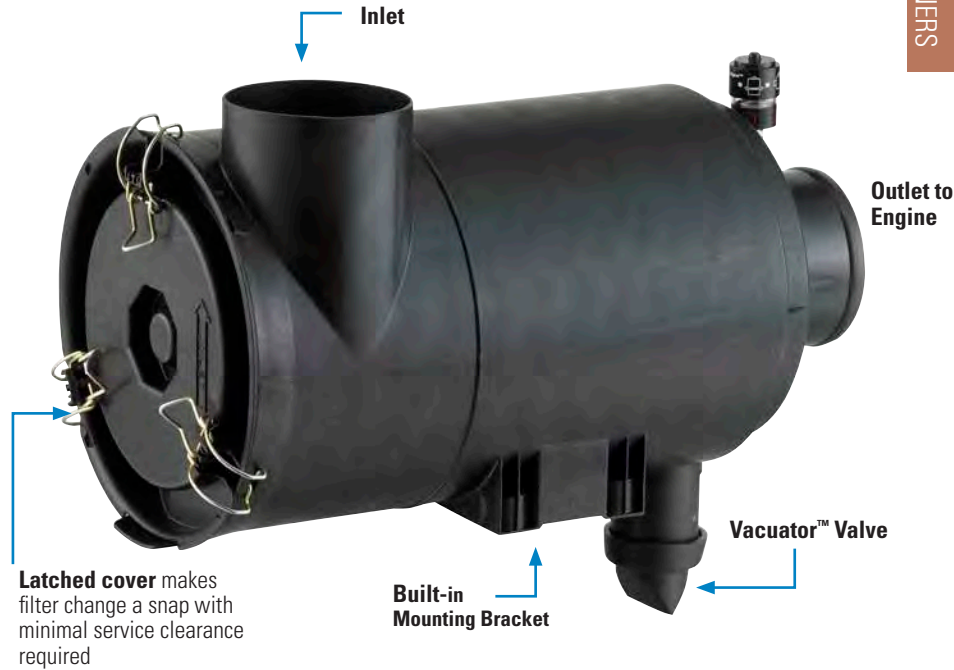

Primary and safety filters for XRБ housings.

### Installation Recommendations

- Air cleaner orientation is horizontal, with the drop tube pointing down — within +/- 15°. For service clearance, allow the entire length of the filter for removal and 1.38" (35mm) for service cover latches.
- Mounting is M8 x 1.25, with a maximum torque of 15 ft•lb.
- Connections: Inlet/Outlet maximum torque 40 in•lb.
- **Inlet accessory note:** The air cleaner housing can accommodate a plastic inlet hood or plastic TopSpin™ pre-cleaner, but not a metal pre-cleaner or accessory.
- Filter Service Indicator port arrives with plug/cap. Order filter service indicator separately. See accessories section. Indicator port maximum torque 1.5 ft•lb.



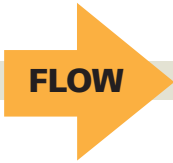

**Flow** Air in the Side, out the End (standard flow filters)

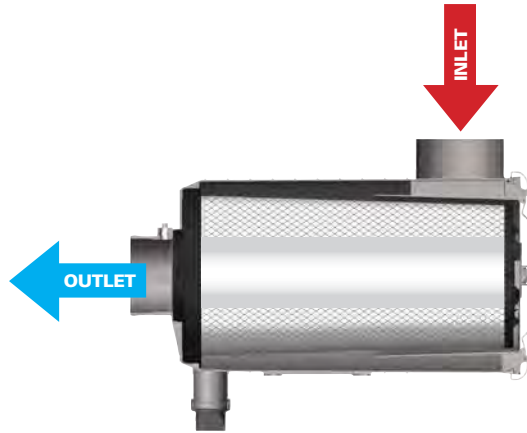

**When Selecting an Air Cleaner . . .**

Determine the airflow requirements of your engine, then find the corresponding cfm airflow in the table at right. The restriction numbers (shown in inches of water) indicate the approximate initial restriction of each model air cleaner at that cfm. If there are two air cleaner models that fit your parameters, choosing the one with the lower restriction will provide longer filter service life. When calculating total initial restriction of the entire air intake system, include the restriction caused by ducting, elbows, and pre-cleaners. See pages 257-258 for ducting restriction estimates.

**Initial Airflow Restriction**

CFM @ H <sub>2</sub> O			Air Cleaner Model
6"	8"	10"	
265	315	360	B080080
330	405	475	B100127
475	555	630	B120470

**XR Air Cleaner Performance Curves (Restriction & Dust Capacity)\***

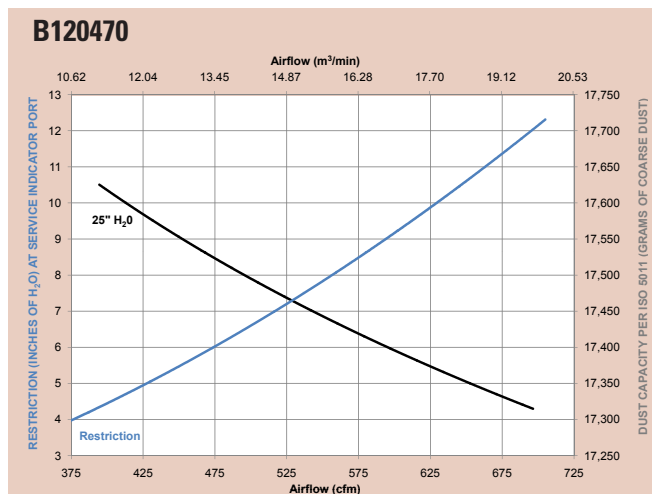
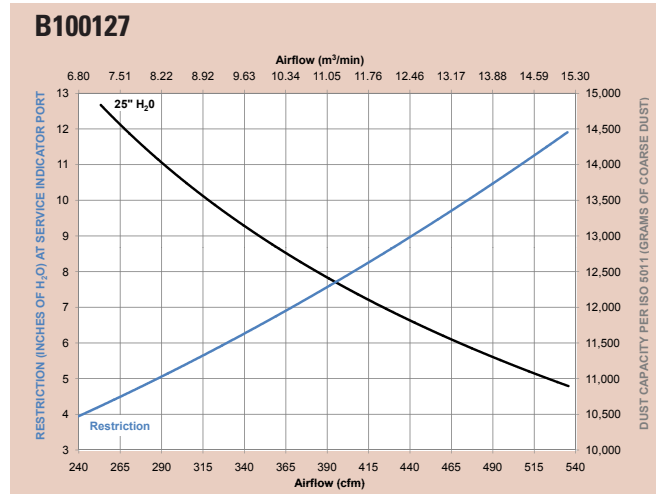
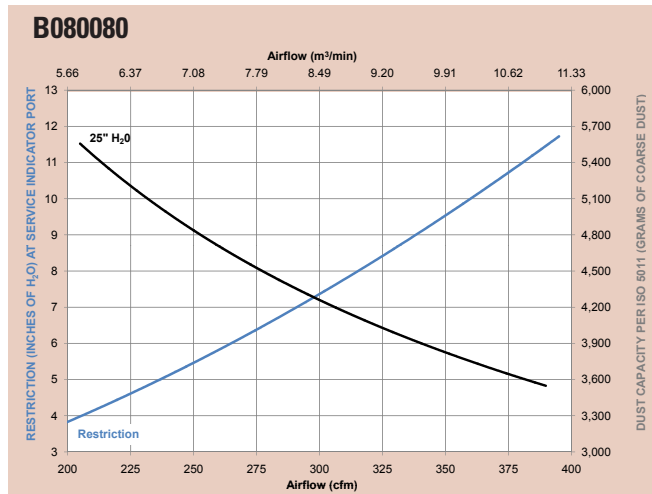

\*Results generated using laboratory testing pursuant to ISO5011. Actual performance during use may vary depending on multiple factors, including specific product configuration, external conditions and application.

**XRB Specification Illustration**

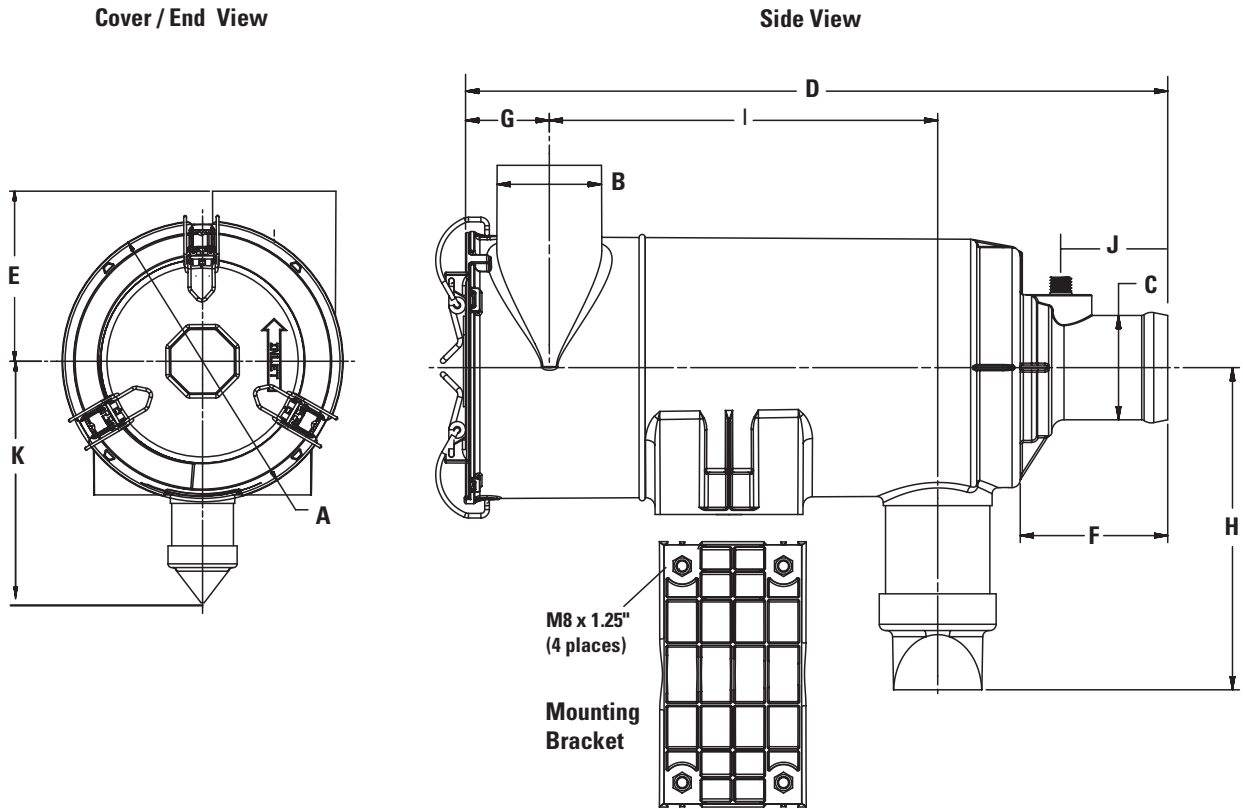

**XRB Specifications**

Air Cleaner Models	Body Dia. (A)	Inlet Dia. (B)	Outlet Dia. (C)	Housing Length (D)	Inlet Height (E)	Outlet Length (F)	Inlet Location (G)	Center Line to Valve (H)	Service Clear. (I)	Weight	Restr. Tap Loc. (J)	Mounting Bracket Height (K)
B080080	9.11" 231.3mm	4.00" 102mm	4.00" 102mm	16.75" 425mm	5.50" 140mm	2.40" 61mm	3.14" 80mm	7.78" 198mm	14.76" 375mm	5.52lb 2.5kg	1.57" 40mm	4.33" 110mm
B100127	11.31" 287mm	5.00" 127mm	4.50" 114mm	22.25" 565mm	7.80" 198mm	2.82" 72mm	3.47" 88mm	8.85" 225mm	19.41" 493mm	13.00lb 5.95kg	1.97" 50mm	5.71" 145mm
B120470	13.00" 330mm	6.00" 152mm	5.00" 128mm	23.68" 601mm	8.58" 218mm	2.81" 71mm	3.95" 100mm	9.63" 245mm	20.71" 526mm	20.00lb 9.07kg	1.97" 50mm	6.50" 165mm



## 8" Models (B080080)

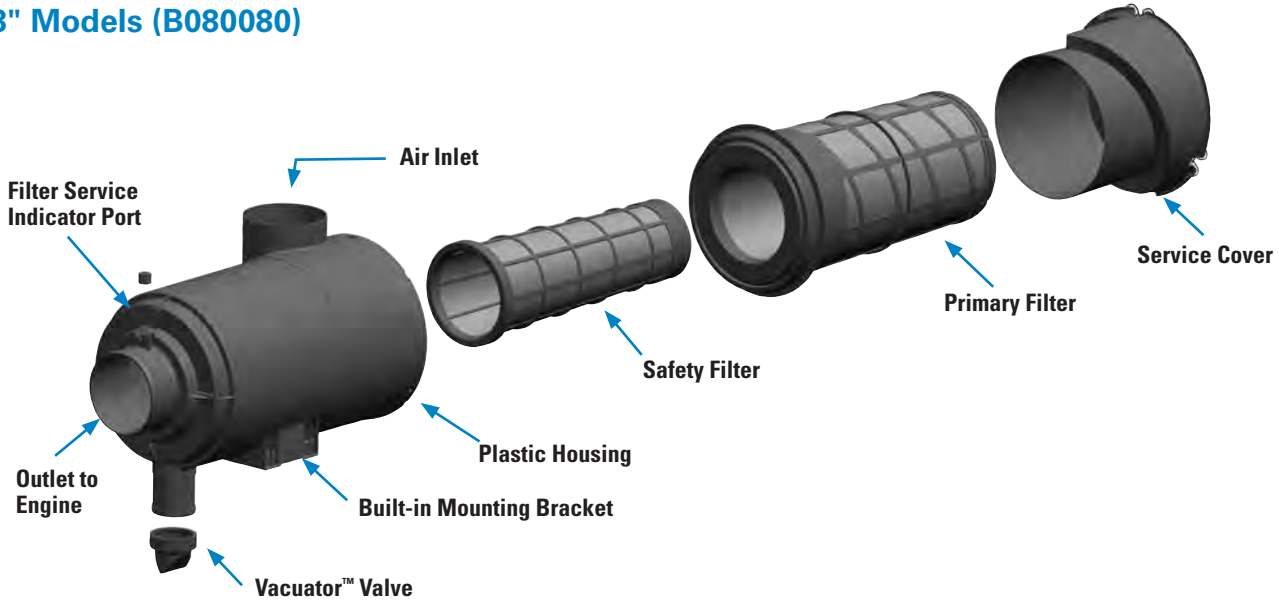

## 10" and 12" Models (B100127, B120470)

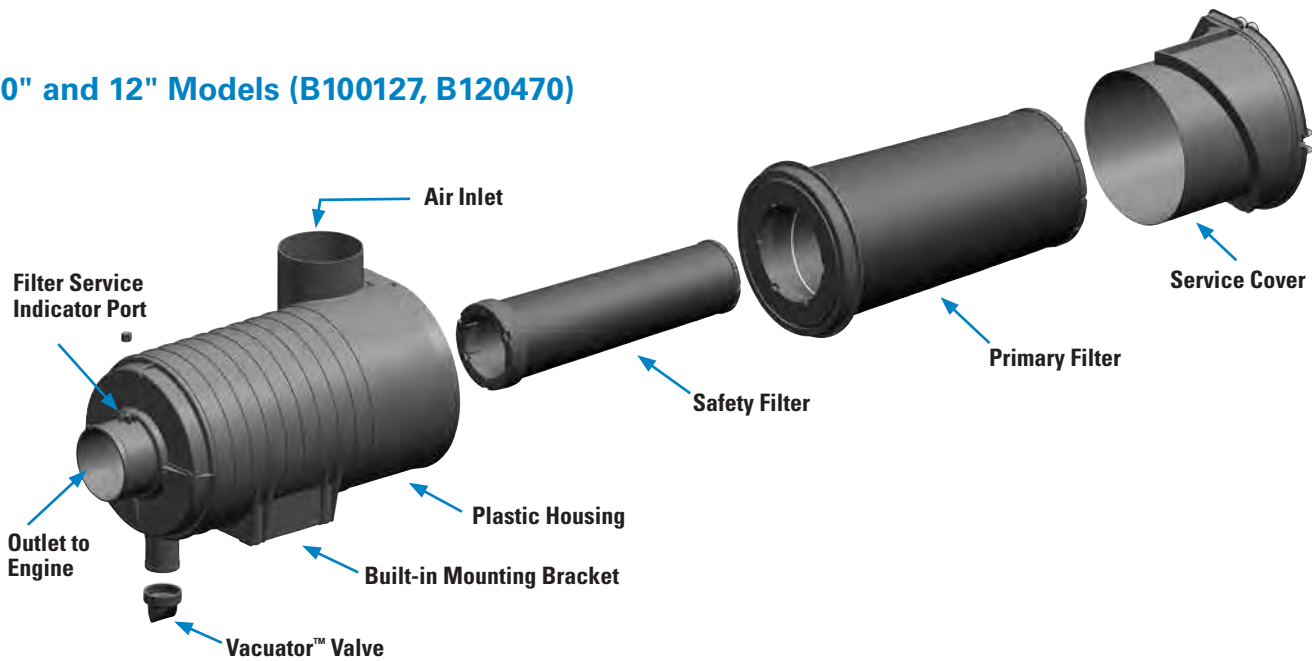

## Service Parts & Accessories

B080080	XRB	
Cover		P605731
Elbow, 45°		P105545
Elbow, 90°		P105533
Elbow, 90° reducing		P121482
Filter, primary (non metal)		P611190.....3
Filter, safety		P611189.....3
Hump hose		P105609
Informer™ indicator 25" H <sub>2</sub> O		X002277
Inlet hood, plastic		H000467
Outlet band clamp		P148343
Vacuator™ Valve		P158914

B100127	XRB	
Cover		P609942
Elbow, 45°		P114316
Elbow, 90°		P113733
Filter, primary (metal liner)		P611539.....3
Filter, safety		P611540.....3
Hump hose		P114317
Informer™ indicator 25" H <sub>2</sub> O		X002277
Inlet hood, metal		H000165
Inlet hood, plastic		H000469
Outlet band clamp		P148344
Vacuator™ Valve		P158914

B120470	XRB	
Cover		P608117
Elbow, 45°		P109021
Elbow, 90°		P107844
Elbow, 90° reducing		P143895
Filter, primary (metal liner)		P608116.....3
Filter, safety		P608391.....3
Hump hose		P105610
Informer™ indicator 25" H <sub>2</sub> O		X002277
Inlet hood, metal		H000275
Inlet hood, plastic		H000606
Outlet band clamp		P148345
Vacuator™ Valve		P158914

**NOTES:**  
3 = Shipped with air cleaner initially

This servicing information is provided as a best practices guide. It is not intended to replace or supersede the service instructions supplied by your engine or vehicle manufacturer.

## 1 Check the Restriction

Replace the filter only when the restriction level has reached the maximum recommended by the engine or equipment manufacturer or on a regular service schedule.



## 2 Clean out the Vacuator™ Valve

Remove the Vacuator Valve and clean out any dust found in the drop tube. Reinstall Vacuator Valve or replace if it is worn or damaged.



## 3 Remove Service Cover

Unlatch and remove the service cover on the air cleaner to access the filters.



## 4 Remove the Primary Filter

The primary filter makes such a tight seal, that you will encounter some initial resistance, similar to breaking the seal on a jar. To break the seal, grab the end of the filter and gently move the filter from side-to-side and pull it out of the housing.

*Application Note: Avoid dislodging contaminant from the filter when it is removed from the air cleaner housing.*



Continued on next page





### 5 Remove the Safety Filter

Replace the safety filter with every third primary filter change unless excessive dust has settled on it during servicing. If you are reusing the safety filter keep it clean while servicing the housing to avoid contamination.

Remove the safety filter by pulling it straight out — giving you easy access to properly clean the primary filter's seal surface.

Block the outlet tube of the air cleaner, using a small dampened towel, prior to cleaning the seal surface to avoid contaminating the induction system.



*If a safety filter is not present, check to see it has attached itself to the inside of the primary filter during removal. Inspect the seal surface and housing for any damage. Replace the complete air cleaner if damage is present.*

### 6 Clean the Inside Surface

With a second clean damp cloth, thoroughly clean the inside of the housing and seal surface.



*Failure to clean the surface may cause contaminants to be introduced to the outlet tube or onto the seal area of the primary filter during reinstallation, resulting in a dirty air leaks.*

### 7 Inspect the Primary and Safety Filters

Inspect new filters for any damage, voids, cuts, tears or indentations in the media or urethane sealing surface. If the filter is damaged, do not install.



### 8 Install the Safety Filter

Remove the dampened towel from the outlet tube that was used to protect the induction system during servicing.

Install the safety filter by pressing it firmly in place until seated. When properly fitted it should fit snugly inside the outlet tube.



## 9 Install the Primary Filter

Install the new primary filter by gently sliding it over the safety filter and pressing it into place until fully seated. When installing, apply pressure by hand at the outer rim of the filter, not in the center, to complete a tight seal. Continue pushing the filter into the outlet tube until it stops. The critical sealing area will compress slightly, adjust itself, and distribute the sealing pressure evenly.



*If you perform filter maintenance service on a schedule versus using service indicators, you may want to write the service date on the filter end cap.*

## 10 Fasten the Service Cover

Replace the service cover, with the "INLET" arrow lined up with the air cleaner inlet. Do not force the cover onto the air cleaner or use the service cover to push the filter into place.

Refasten latches to secure the cover and make sure that the latches penetrate the slots in both the body and the cover.

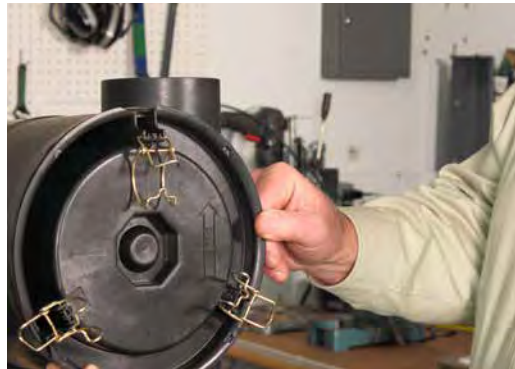

*If the cover does not fit flush to the body, the primary filter is not properly seated in the housing. Recheck the primary and safety filter installation, following the proper installation procedure so they become fully seated. The cover will then go on easily. Using the cover to push the filters could cause damage to the housing and will void the warranty.*

## 11 Inspect the Air Cleaner System

Inspect and torque all clamps, bolts and connections in the entire air intake system. Check for holes in piping and repair if needed.

Reset the filter service indicator if applicable.







## Advanced Sealing Technology in Compact Two-Stage Design For the Most Reliable Engine Protection

The FPG Air Cleaner series is a two-stage engine air cleaner operating in medium to heavy dust conditions. The FPG series offers improved reliability and durability with reduced weight and costs.

Ever since Donaldson developed the first air cleaner in 1915, we have worked closely with original equipment manufacturers to provide filtration solutions to meet changing design and specification requirements for diesel engines.

Because they are made of injection molded high-strength plastic, FPG air cleaners offer the flexibility to overcome space limitations for underhood air cleaners. Donaldson employs innovative plastic materials and production techniques that result in air cleaners that are corrosion-free and lighter in weight than traditional metal air cleaners — yet without sacrificing sturdiness. Our extensive vibration testing reveals this to be a more durable design than most metal air cleaners.

The filter inside the air cleaner is also quite different from the traditional design: one-piece molded urethane endcaps encase the ends of the media and filter liners, eliminating the metal caps and plastisol potting compound that were traditionally used. The glued-on gasket found on Axial filters is gone — now, the inside surface of the open end is actually the RadialSeal™ sealing surface.

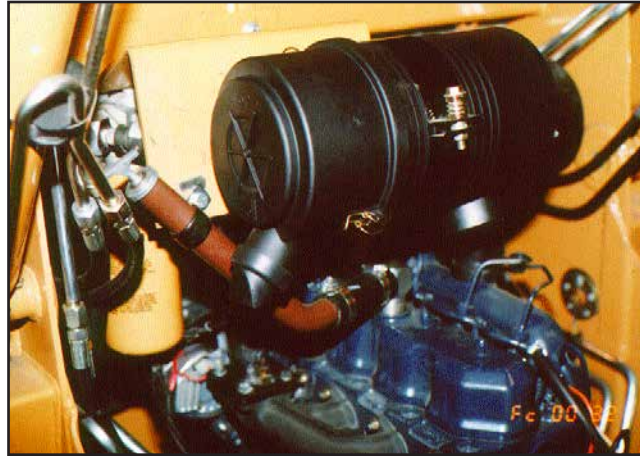

*Despite its compact size, the FPG Air Cleaner offers complete engine air protection — removing 99.9% of the dust and dirt particulate that enters the engine airstream.*



*FPG and FPG Alexin™ Air Cleaners, with RadialSeal™ Sealing Technology, provide thorough two-stage cleaning of incoming engine air on industrial and construction vehicles operating in medium to heavy dust environments.*

## Small, Durable and Corrosion-Free The Easiest Air Cleaner to Service!

### Applications

- Provides up to 346 cfm airflow per air cleaner — double throughput by using two units
- Installation can be horizontal, vertical, or even at an angle (as long as Vacuator™ Valve points down)
- Temperature tolerance: 180 °F / 83 °C sustained (Do not install next to turbocharger, muffler, exhaust pipes, or other high-temp component.)

### Ideal for

- Compressors and generator sets
- Construction and in-plant vehicles
- On- and off-highway vehicles
- Marine and offshore equipment

### Air Cleaner Features

- Easy to service. No tools needed. Usually done in 5 minutes or less.
- Durable plastic housing — corrosion-free and lightweight
- Two-stage air filtration. Built-in, tangential pre-cleaner ahead of primary filter removes up to 85% of incoming dust.
- Choose 90° or straight outlet to fit your application.
- Easy-to-fasten latches retain dust cup/cover. Four (larger) models have twist-off cover.
- Tapped to accept filter service indicator.
- A plastic inlet hood and stack (up to 18" /457mm tall) may be added.

### Filter Features

- Filters have RadialSeal™ Sealing Technology that creates a reliable, critical seal and makes servicing easy.
- One piece, molded urethane endcaps encase the filter media and liners.
- Safety filter protects engine during in-field filter change outs. All FPG models can accept safety filters. Specification table shows which air cleaner models ship with a safety filter installed.
- High efficiency, extended service, Donaldson Blue® filters are available on some models (see service parts list on page 121 for part numbers)



Try PowerPleat™ for the 5" see page 53.





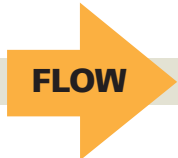

# G

**Air in the Side, Out the End** (standard flow filters)

## When Selecting an Air Cleaner . . .

Determine the airflow requirements of your engine, then find the corresponding cfm airflow in the table at right. The restriction numbers (shown in inches of water) indicate the approximate initial restriction of each model air cleaner at that cfm. If there are two air cleaner models that fit your parameters, choosing the one with the lower restriction will provide longer filter service life. When calculating total initial restriction of the entire air intake system, include the restriction caused by ducting, elbows, and pre-cleaners. See pages 257-258 for ducting restriction estimates.

## Initial Airflow Restriction

Airflow CFM @ H <sub>2</sub> O			Air Cleaner Model	
6"	8"	10"	90°	Straight
<b>MODELS WITH PRIMARY FILTER ONLY</b>				
55	65	70	G042545	G042544
80	95	105	G057514	G057513
120	135	155	G065433	G065432
150	170	190	G070020	G070019
205	245	275	G082528	G082527
<b>MODELS WITH PRIMARY &amp; SAFETY FILTER</b>				
65	80	90	G057512	G057511
110	125	145	G065411	G065424
125	145	165	G070018	G070017
165	190	215	G082526	G082525
247	282	314	G100317 <sup>1</sup>	
259	297	328		G100319 <sup>1</sup>
265	300	335		G090225 <sup>1</sup>
256	317	346	G090219 <sup>1</sup>	

1 - Models with twist-off cover design (no latches)

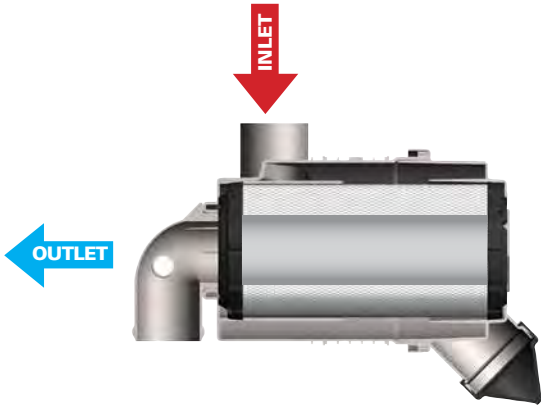

## FPG Air Cleaner Performance Curves\*

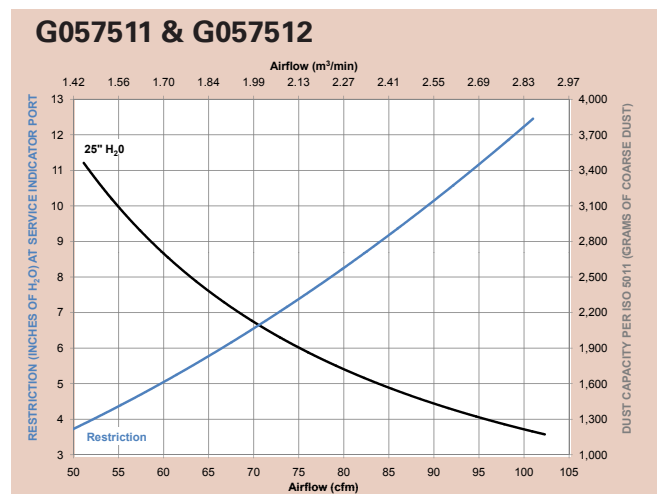
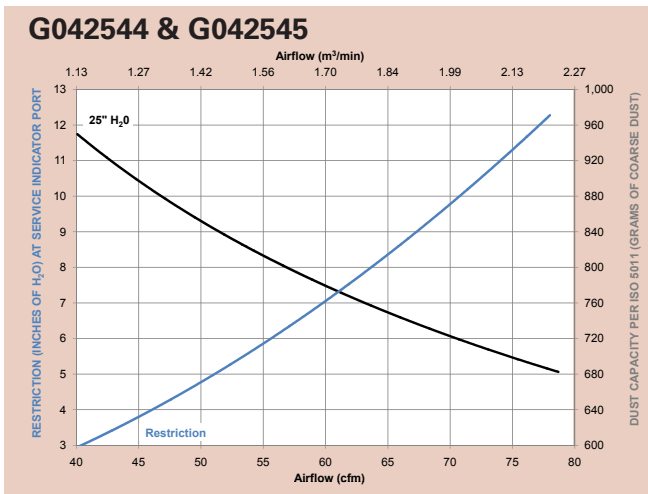

\*Results generated using laboratory testing pursuant to ISO5011. Actual performance during use may vary depending on multiple factors, including specific product configuration, external conditions and application.

continued — FPG Air Cleaner Performance Curves (Restriction & Dust Capacity)

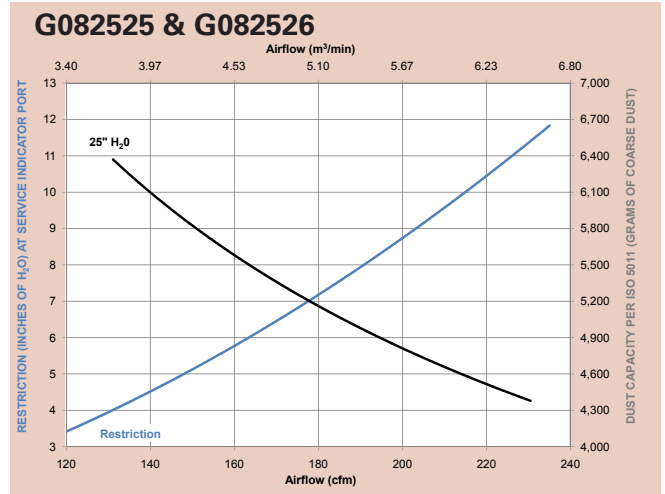
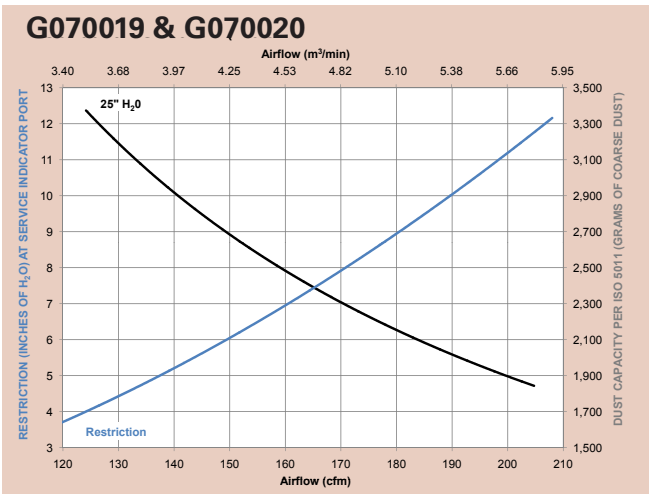
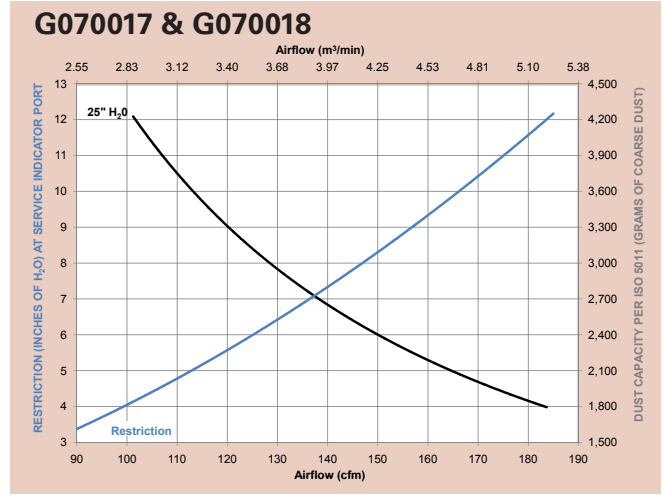
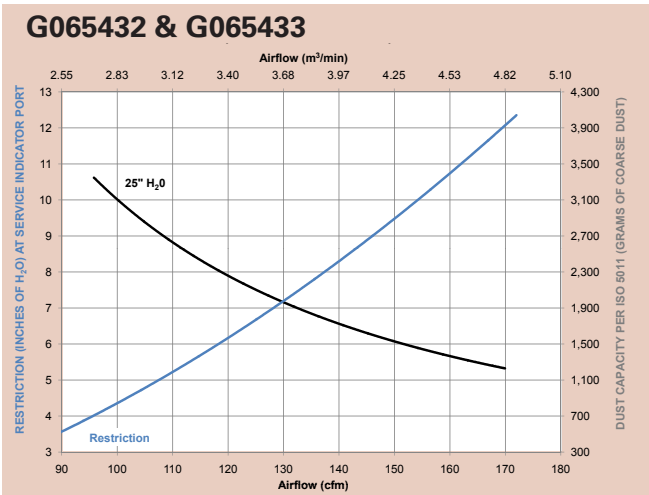
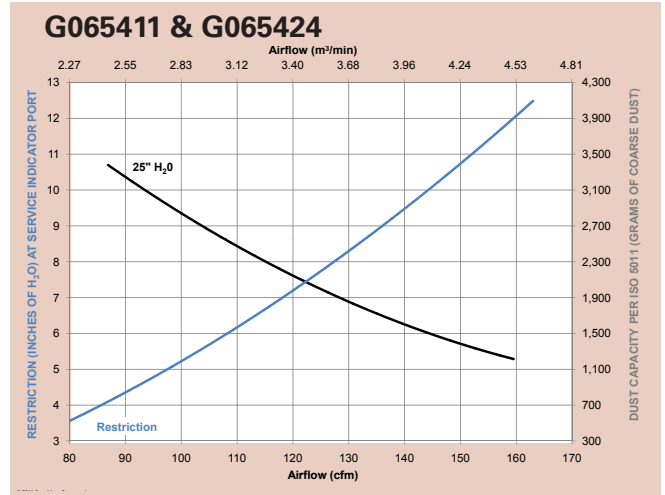
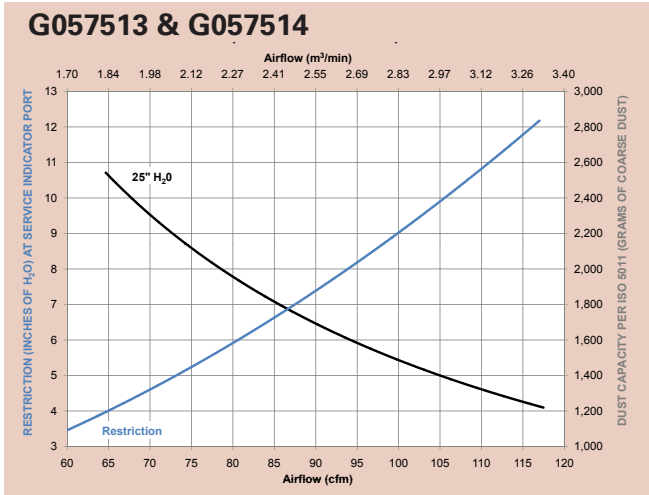



continued — FPG Air Cleaner Performance Curves (Restriction & Dust Capacity)

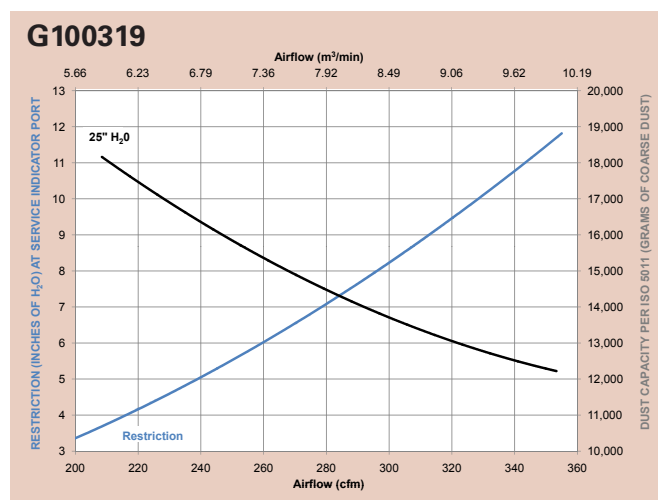
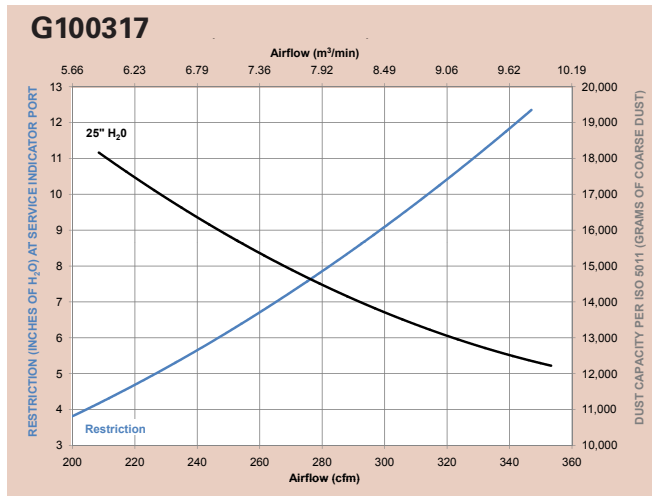
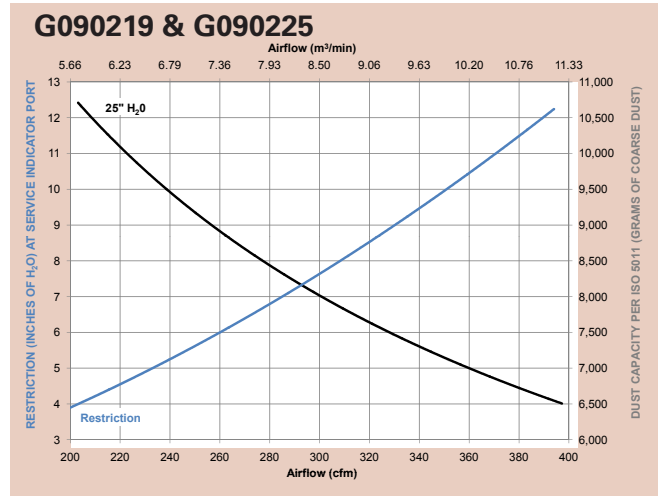
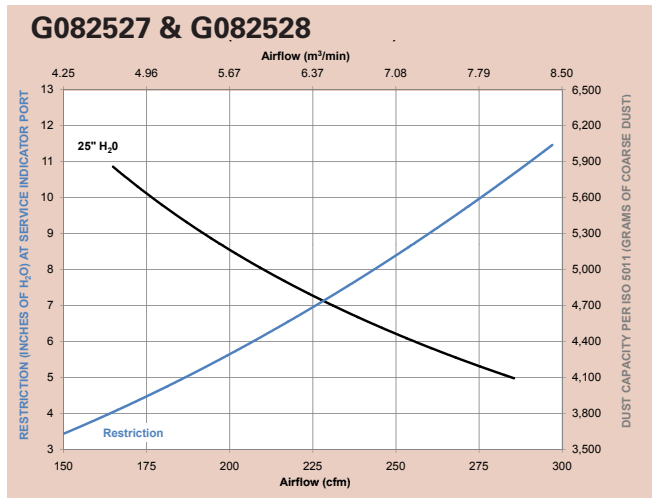

**FPG Specification Illustrations**

90° Elbow Outlet Model

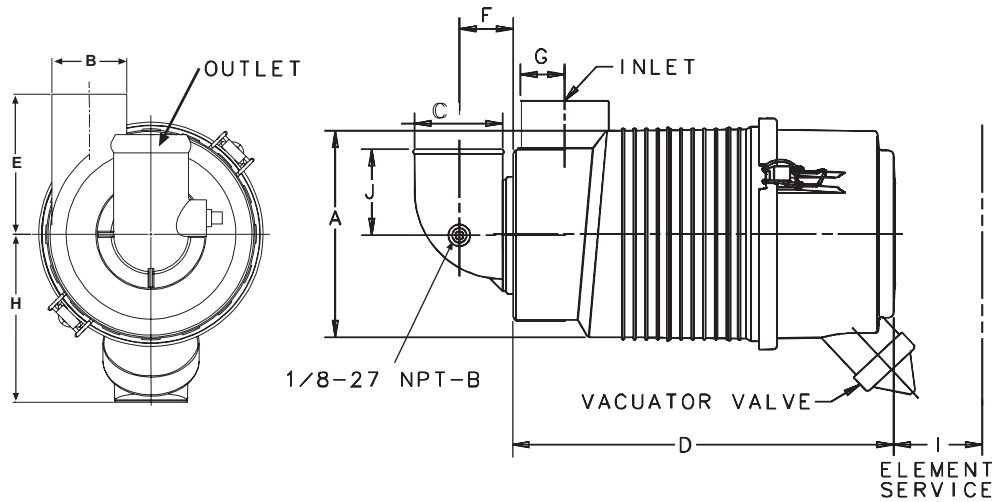

**FPG Specifications**

Air Cleaner Models	with Safety Filter?	Body Dia. (A)	Inlet Dia. (B)	Outlet Dia. (C)	Housing Length (D)	Inlet Height (E)	Outlet Length (F)	Inlet Location (G)	Center Line to Valve (H)	Service Clear. (I)	Weight lbs kg	Restr. Tap Loc. (J)
<b>MODELS WITH 90° ELBOW OUTLET TUBE</b>												
G042545	no	4.80" 122mm	1.75" 44mm	1.75" 44mm	7.45" 189mm	3.27" 83mm	1.23" 31mm	1.48" 38mm	3.96" 101mm	5.39" 137mm	1.3 lbs 0.6 kg	1.94" 48mm
G057512	yes	5.75" 146mm	2.00" 51mm	2.00" 51mm	10.96" 278mm	3.82" 97mm	1.36" 35mm	1.65" 42mm	4.66" 118mm	10.68" 271mm	2.5 lbs 1.1 kg	2.60" 66mm
G057514	no	5.75" 146mm	2.00" 51mm	2.00" 51mm	10.96" 278mm	3.82" 97mm	1.36" 35mm	1.65" 42mm	4.66" 118mm	7.95" 202mm	2.2 lbs 1.0 kg	2.60" 66mm
G065411	yes	6.74" 171mm	2.50" 64mm	2.50" 64mm	12.61" 320mm	4.41" 112mm	1.60" 41mm	1.70" 43mm	5.35" 136mm	12.24" 311mm	3.9 lbs 1.8 kg	3.06" 78mm
G065433	no	6.74" 171mm	2.50" 64mm	2.50" 64mm	12.61" 320mm	4.41" 112mm	1.60" 41mm	1.70" 43mm	5.35" 136mm	8.50" 216mm	3.5 lbs 1.6 kg	3.06" 78mm
G070018	yes	7.19" 183mm	3.00" 76mm	3.00" 76mm	13.09" 332mm	4.88" 124mm	1.88" 48mm	1.72" 44mm	5.45" 137mm	12.50" 318mm	4.3 lbs 1.9 kg	3.62" 92mm
G070020	no	7.19" 183mm	3.00" 76mm	3.00" 76mm	13.09" 332mm	4.88" 124mm	1.88" 48mm	1.72" 44mm	5.45" 137mm	8.87" 225mm	3.8 lbs 1.7 kg	3.62" 92mm
G082526	yes	8.35" 212mm	3.75" 95mm	3.50" 89mm	14.23" 361mm	5.43" 138mm	2.11" 54mm	2.11" 54mm	6.01" 153mm	13.91" 353mm	5.8 lbs 2.6 kg	4.13" 105mm
G082528	no	8.35" 212mm	3.75" 95mm	3.50" 89mm	14.23" 361mm	5.43" 138mm	2.11" 54mm	2.10" 53mm	6.01" 153mm	9.57" 243mm	5.2 lbs 2.3 kg	4.13" 105mm

**Application Notes**

- 1) Safety filters: All FPG models can accept safety filters. This table shows which air cleaner models are shipped with a safety filter installed. If you want to add a safety filter to an existing model that did not originally have one, order the safety filter listed in the Service Parts table.
- 2) Mounting band specifications and ordering information are on page 119.
- 3) Inlet Accessories: A plastic inlet hood, a plastic TopSpin™ pre-cleaner, and/or a stack up to 18" (457mm) tall may be added to the inlet. See the Accessories section for information on optional inlet hoods and TopSpin pre-cleaners.
- 4) Service Indicators. See the Accessories section for information on filter service indicators.





## FPG Specification Illustrations

### Straight Outlet Tube Model

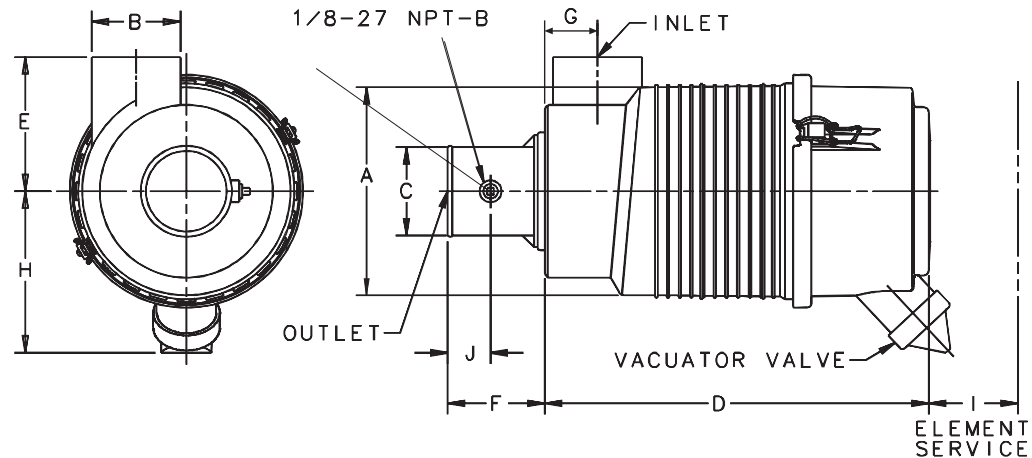

## FPG Specifications

Air Cleaner Models	with Safety Filter?	Body Dia. (A)	Inlet Dia. (B)	Outlet Dia. (C)	Housing Length (D)	Inlet Height (E)	Outlet Length (F)	Inlet Location (G)	Center Line to Valve (H)	Service Clear. (I)	Weight lbs kg	Restr. Tap Loc. (J)
<b>MODELS WITH STRAIGHT OUTLET TUBE</b>												
G042544	no	4.80" 122mm	1.75" 44mm	1.75" 44mm	7.45" 189mm	3.27" 83mm	3.24" 82mm	1.48" 38mm	3.96" 101mm	5.39" 137mm	1.3 lbs 0.6 kg	1.88" 48mm
G057511	yes	5.75" 146mm	2.00" 51mm	2.00" 51mm	10.87" 276mm	3.82" 97mm	3.25" 83mm	1.65" 42mm	4.66" 118mm	10.68" 271mm	2.5 lbs 1.1 kg	1.88" 48mm
G057513	no	5.75" 146mm	2.00" 51mm	2.00" 51mm	10.87" 276mm	3.82" 97mm	3.25" 83mm	1.65" 42mm	4.66" 118mm	7.95" 202mm	2.2 lbs 1.0 kg	1.88" 48mm
G065424	yes	6.74" 171mm	2.50" 64mm	2.50" 64mm	12.61" 320mm	4.41" 112mm	3.23" 82mm	1.70" 43mm	5.35" 136mm	12.24" 311mm	3.9 lbs 1.8 kg	1.63" 41mm
G065432	no	6.74" 171mm	2.50" 64mm	2.50" 64mm	12.61" 320mm	4.41" 112mm	3.23" 82mm	1.70" 43mm	5.35" 136mm	8.48" 216mm	3.5 lbs 1.6 kg	1.63" 41mm
G070017	yes	7.19" 183mm	3.00" 76mm	3.00" 76mm	13.09" 332mm	4.88" 124mm	3.26" 83mm	1.72" 44mm	5.45" 138mm	12.50" 318mm	4.3 lbs 1.9 kg	1.88" 48mm
G070019	no	7.19" 183mm	3.00" 76mm	3.00" 76mm	13.09" 332mm	4.88" 124mm	3.26" 83mm	1.72" 44mm	5.45" 138mm	8.87" 225mm	3.8 lbs 1.7 kg	1.88" 48mm
G082525	yes	8.35" 212mm	3.75" 95mm	3.50" 89mm	14.23" 361mm	5.43" 138mm	3.27" 83mm	2.10" 53mm	6.01" 153mm	13.91" 353mm	5.8 lbs 2.6 kg	1.91" 49mm
G082527	no	8.35" 212mm	3.75" 95mm	3.50" 89mm	14.23" 361mm	5.43" 138mm	3.27" 83mm	2.10" 53mm	6.01" 153mm	9.57" 243mm	5.2 lbs 2.3 kg	1.91" 49mm

## Application Notes

- 1) Safety filters: All FPG models can accept safety filters. This table shows which air cleaner models are shipped with a safety filter installed. If you want to add a safety filter to an existing model that did not originally have one, order the safety filter listed in the Service Parts table.
- 2) Mounting band specifications and ordering information are on the next page.
- 3) Inlet Accessories: A plastic inlet hood, a plastic TopSpin™ pre-cleaner, and/or a stack up to 18' (457mm) tall may be added to the inlet. See the Accessories section for information on optional inlet hoods and TopSpin pre-cleaners.
- 4) Service Indicators. See the Accessories section for information on filter service indicators.

## Mounting Bands Designed Exclusively for the FPG Series

**WARNING:** Do not use any other mounting bands or straps with FPG air cleaners. Use of an unapproved mounting band voids warranty.

### Polymer Mounting Band

The one-piece, high tech polymer mounting band will securely hold the housing in position. The band has tabs on the inside circumference which fit exactly into notches on the FPG housing. Donaldson polymer bands are completely non-corrosive, lightweight, easy to install, and economical.

The band tightens around the air cleaner when the base of the band is bolted to a support, providing a fixed, stable mounting — even in high vibration applications.

Use on G04 and G05 FPG Air Cleaners.



Use on G06-G10 FPG and Alexin Air Cleaners  
Bands have spring-loaded screws

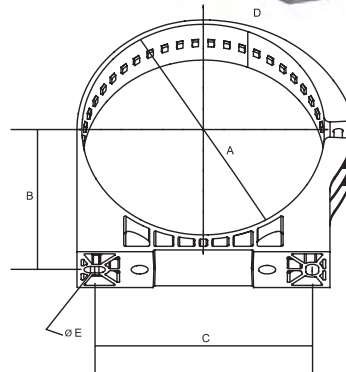
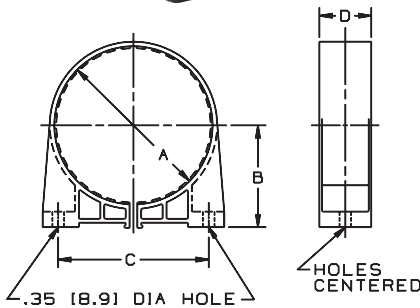

### Metal Mounting Band

The metal mounting band has a spring-loaded bolt at the top to maintain a constant hold on the housing throughout high and low temperature extremes.

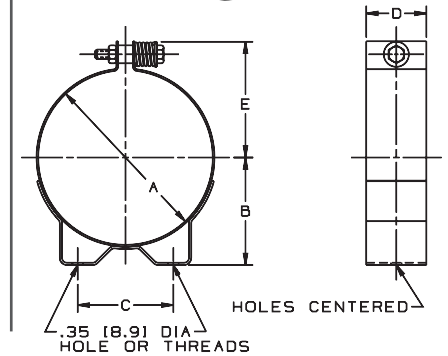

### Maximum Torque

Polymer Bands:  
11 lbs-ft / 14.8 N•m

Metal Bands:  
12 lbs-ft / 16.2 N•m

### Application Note:

To accommodate even hard-to-fit applications, polymer bands allow the air cleaner housings to be rotated and positioned at various increments, depending upon the size:

Housing Diameter	Increment
4.80" (122mm)	11°
5.75" (146mm)	10°
6.74" (171mm)	7.5°
7.19" (183mm)	7.5°
8.35" (212mm)	5°

### FPG Mounting Bands (Order one band per FPG air cleaner)

Part Number	A		B		C		D		E		Weight	
	in	mm	in	mm	in	mm	in	mm	in	mm	lbs	kg
<b>POLYMER BANDS</b>												
P777151	4.80	122	3.09	79	4.56	116	1.57	40	n/a		0.26	118
P777730	5.75	146	3.52	90	5.35	136	1.99	51	n/a		0.37	167
P778810 <sup>1</sup>	6.79	173	3.94	100	6.00	154	1.99	51	n/a		0.40	182
P777731 <sup>1</sup>	7.17	182	4.11	105	6.50	165	1.99	51	n/a		0.45	206
P777732 <sup>1</sup>	8.35	212	4.70	120	7.48	190	1.99	51	n/a		0.56	253
P780532 <sup>1</sup>	9.48	241	5.47	136	5.63	143	1.99	51	n/a			
P780594 <sup>1</sup>	10.55	268	5.90	150	5.63	143	3.15	80	n/a			
<b>METAL BANDS</b>												
H008442	4.80	122	3.07	78	2.76	70	1.57	40	3.34	85	0.70	317
H008443	5.75	146	3.54	90	3.15	80	1.99	51	3.83	97	1.30	590
H008441 <sup>2</sup>	6.79	173	3.94	100	3.54	90	1.99	51	4.35	111	1.40	635
H008444	6.79	173	3.94	100	3.54	90	1.99	51	4.35	111	1.40	635
H002070	7.19	183	4.09	104	3.74	95	1.99	51	4.55	116	1.50	680
H002023	8.35	212	4.72	120	4.33	110	1.99	51	5.14	131	1.60	726

1 - Mounting bands (with spring-loaded screws) for FPG09 and FPG10 models with twist-off cover  
2 - Model H008441 has 8mm threads



## Alexin™ Twist-Off Cover Model

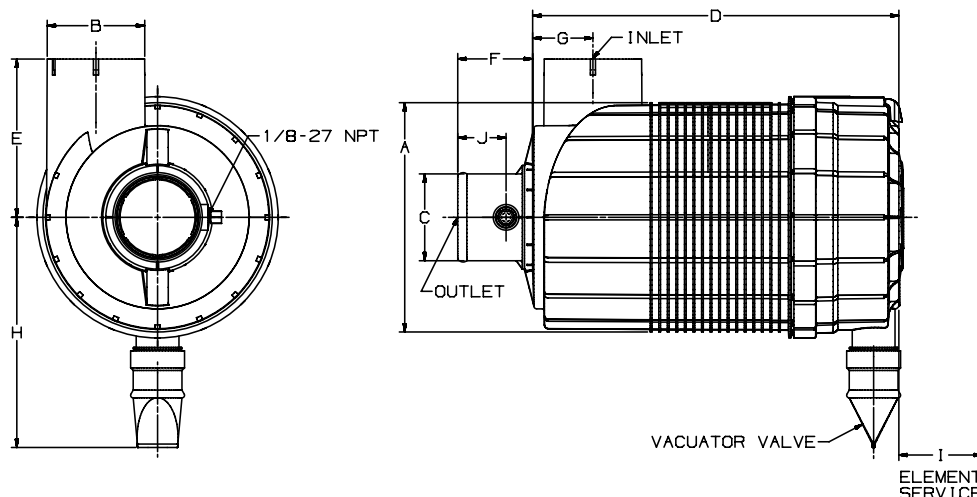

### FPG ALEXIN™

Air Cleaner Models	with Safety Filter?	Body Dia. (A)	Inlet Dia. (B)	Outlet Dia. (C)	Housing Length (D)	Inlet Height (E)	Outlet Length (F)	Inlet Location (G)	Center Line to Valve (H)	Service Clear. (I)	Weight lbs kg	Restr. Tap Loc. (J)
<b>FPG ALEXIN™ MODELS WITH TWIST-OFF COVER (90° AND STRAIGHT OUTLET TUBES)</b>												
G090219 <sup>1</sup>	yes	9.53" 242mm	4.50" 114mm	3.50" 89mm	15.75" 400mm	6.69" 170mm	2.11" 54mm	2.42" 62mm	10.44" 260mm	12.79" 325mm	8.8 lbs 4.0 kg	4.13" 105mm
G100317 <sup>1</sup>	yes	10.55" 268mm	4.50" 114mm	4.00" 102mm	16.85" 428mm	7.28" 185mm	2.37" 60mm	2.85" 73mm	10.60" 269mm	13.98" 355mm	11.1 lbs 5.1 kg	4.72" 120mm
G090225 <sup>2</sup>	yes	9.53" 242mm	4.50" 114mm	4.00" 102mm	15.75" 400mm	6.69" 170mm	3.43" 87mm	2.42" 62mm	10.04" 260mm	12.79" 325mm	8.7 lbs 3.9 kg	2.22" 57mm
G100319 <sup>2</sup>	yes	10.55" 268mm	4.50" 114mm	4.00" 102mm	16.85" 428mm	7.28" 185mm	3.45" 88mm	2.85" 73mm	10.60" 269mm	13.98" 355mm	10.9 lbs 4.9 kg	2.22" 57mm

1 - FPG Alexin Models with 90° outlet tube

2 - FPG Alexin models with straight outlet tube

### FPG Service Parts

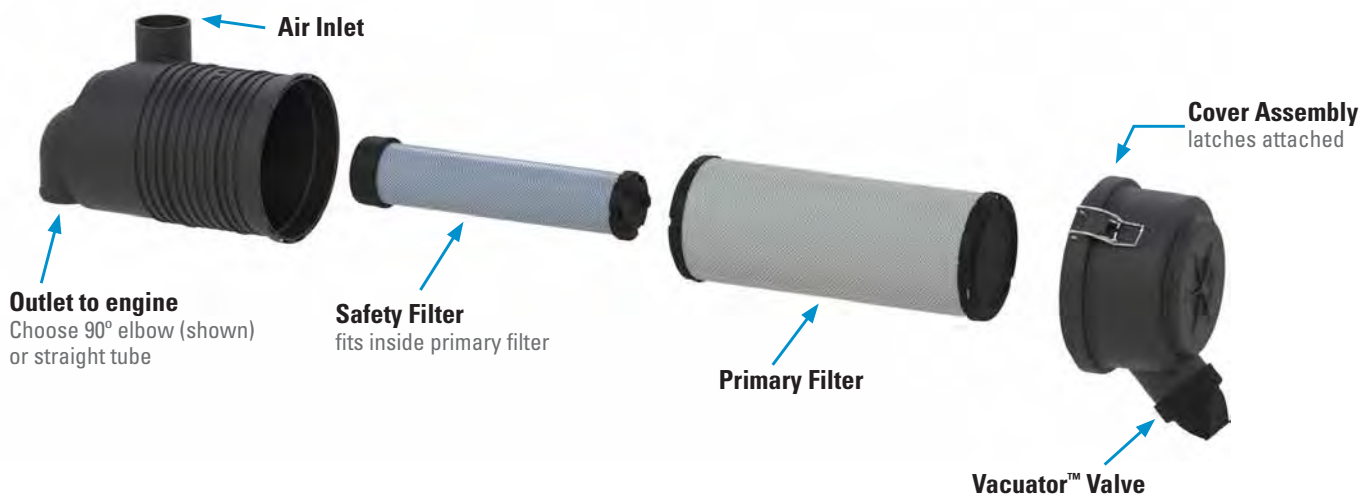

**FPG Service Parts & Accessories**

<b>G042544 &amp; G042545 FPG</b>	
Cover.....	P533685 .....8
Filter, primary.....	P822686 .....3
Filter, safety.....	P535396 .....4
Informer™ indicator 25" H <sub>2</sub> O.....	X002277
Inlet hood, plastic.....	H002068
Latch.....	P538928
Mounting bands, metal.....	H008442
Mounting Bands, plastic.....	P777151
Outlet band clamp.....	P115200
Vacuator™ Valve.....	P522958

<b>G057511 &amp; G057512 FPG</b>	
Cover.....	P533761 .....8
Elbow, 45°.....	P105541
Elbow, 90°.....	P105529
Filter, primary.....	P821575 .....3
Filter, safety.....	P822858 .....3
Informer™ indicator 25" H <sub>2</sub> O.....	X002277
Inlet hood, plastic.....	H001377
Latch.....	P538928
Mounting bands, metal.....	H008443
Mounting Bands, plastic.....	P777730
Outlet band clamp.....	P148337
Vacuator™ Valve.....	P522958

<b>G057513 &amp; G057514 FPG</b>	
Cover.....	P533761 .....8
Elbow, 45°.....	P105541
Elbow, 90°.....	P105529
Filter, primary.....	P821575 .....3
Filter, safety.....	P822858 .....4
Informer™ indicator 25" H <sub>2</sub> O.....	X002277
Inlet hood, plastic.....	H001377
Latch.....	P538928
Mounting bands, metal.....	H008443
Mounting Bands, plastic.....	P777730
Outlet band clamp.....	P148337
Vacuator™ Valve.....	P522958

<b>G065411 &amp; G065424 FPG</b>	
Cover.....	P539422 .....8
Elbow, 45°.....	P105543
Elbow, 90°.....	P105531
Filter, primary.....	P822768 .....3
Filter, safety.....	P822769 .....3
Informer™ indicator 25" H <sub>2</sub> O.....	X002277
Inlet hood, plastic.....	H001378
Latch.....	P538928
Mounting bands, metal.....	H008441 or H008444
Mounting Bands, plastic.....	P778810
Outlet band clamp.....	P148339
Vacuator™ Valve.....	P158914

<b>G065432 &amp; G065433 FPG</b>	
Cover.....	P539422 .....8
Elbow, 45°.....	P105543
Elbow, 90°.....	P105531
Filter, primary.....	P822768 .....3
Filter, safety.....	P822769 .....4
Informer™ indicator 25" H <sub>2</sub> O.....	X002277
Inlet hood, plastic.....	H001378
Latch.....	P538928
Mounting bands, metal.....	H008441 or H008444
Mounting Bands, plastic.....	P778810
Outlet band clamp.....	P148339
Vacuator™ Valve.....	P158914

<b>G070017 &amp; G070018 FPG</b>	
Cover.....	P536202 .....8
Elbow, 45°.....	P105544
Elbow, 90°.....	P105532
Elbow, 90° reducing.....	P123462
Filter, primary-Donaldson Blue®.....	DBA5225
Filter, primary.....	P827653 .....3
Filter, safety.....	P829332 .....3
Hump hose.....	P105608
Informer™ indicator 25" H <sub>2</sub> O.....	X002277
Inlet hood, plastic.....	H001379
Latch.....	P538928
Mounting bands, metal.....	H002070
Mounting Bands, plastic.....	P777731
Outlet band clamp.....	P148341
Vacuator™ Valve.....	P158914

<b>G070019 &amp; G070020 FPG</b>	
Clamp.....	P003951
Cover.....	P536202 .....8
Elbow, 45°.....	P105544
Elbow, 90°.....	P105532
Elbow, 90° reducing.....	P123462
Filter, primary-Donaldson Blue®.....	DBA5225
Filter, primary.....	P827653 .....3
Filter, safety.....	P829332 .....4
Hump hose.....	P105608
Informer™ indicator 25" H <sub>2</sub> O.....	X002277
Inlet hood, plastic.....	H001379
Latch.....	P538928
Mounting bands, metal.....	H002070
Mounting Bands, plastic.....	P777731
Outlet band clamp.....	P148341
Vacuator™ Valve.....	P158914

<b>G082525 &amp; G082526 FPG</b>	
Cover.....	P534048 .....8
Elbow, 45°.....	P109331
Elbow, 90°.....	P114318
Filter, primary-Donaldson Blue®.....	DBA5227
Filter, primary.....	P828889 .....3
Filter, safety.....	P829333 .....3
Hump hose.....	P114319
Informer™ indicator 25" H <sub>2</sub> O.....	X002277
Inlet hood, plastic.....	H000466
Latch.....	P538928
Mounting bands, metal.....	H002023
Mounting Bands, plastic.....	P777732
Outlet band clamp.....	P148342
Vacuator™ Valve.....	P158914

<b>G082527 &amp; G082528 FPG</b>	
Clamp.....	P102025
Cover.....	P534048 .....8
Elbow, 45°.....	P109331
Elbow, 90°.....	P114318
Filter, primary-Donaldson Blue®.....	DBA5227
Filter, primary.....	P828889 .....3
Filter, safety.....	P829333 .....4
Hump hose.....	P114319
Informer™ indicator 25" H <sub>2</sub> O.....	X002277
Inlet hood, plastic.....	H000466
Latch.....	P538928
Mounting bands, metal.....	H002023
Mounting Bands, plastic.....	P777732
Outlet band clamp.....	P148342
Vacuator™ Valve.....	P158914

<b>G090219 &amp; G090225* FPG</b>	
Cover.....	P780524
Elbow, 45°.....	P105545
Elbow, 90°.....	P105533
Elbow, 90° reducing.....	P121482
Filter, primary-Donaldson Blue®.....	DBA5226
Filter, primary.....	P780522
Filter, safety.....	P780523 .....3
Hump hose.....	P105609
Informer™ indicator 25" H <sub>2</sub> O.....	X002277
Inlet hood, metal.....	H000170
Inlet hood, plastic.....	H000468
Mounting Bands, plastic.....	P780532 .....10
Outlet band clamp.....	P148343
Vacuator™ Valve.....	P776008

<b>G100317 &amp; G100319* FPG</b>	
Cover.....	P780578
Elbow, 45°.....	P105545
Elbow, 90°.....	P105533
Elbow, 90° reducing.....	P121482
Filter, primary-Donaldson Blue®.....	DBA5228
Filter, primary.....	P781039
Filter, safety.....	P777639 .....3
Hump hose.....	P105609
Informer™ indicator 25" H <sub>2</sub> O.....	X002277
Inlet hood, metal.....	H000170
Inlet hood, plastic.....	H000468
Mounting Bands, plastic.....	P780594 .....10
Outlet band clamp.....	P148343
Vacuator™ Valve.....	P776008

**NOTES:**

- 3 = Shipped with air cleaner initially
- 4 = Safety filter is designed to fit this air cleaner, but was not originally shipped with it (note that adding a safety filter will decrease the maximum airflow throughput)
- 8 = Cover assembly includes latches but no Vacuator™ Valve
- 10 = This air cleaner requires two mounting bands

Donaldson Blue® = High Efficiency, Extended Service

\* = FPG Alexin models with twist off cover design (no latches)





## UL Listed Air Cleaners

### UL Listed FPG Air Cleaners

Air Cleaner Size	Part Number	Primary Element	Secondary Element	Outlet Tube Type
FPG04	G042547	P831520	–	Straight
FPG04	G042549	P831520	–	90°
FPG05	G057517	P831424	–	Straight
FPG05	G057516	P831424	–	90°
FPG06	G065427	P532410	–	Straight
FPG06	G065426	P532410	–	90°
FPG07	G070070	P535770	P542711	Straight
FPG07	G070026	P535770	–	Straight
FPG07	G070027	P535770	–	90°
FPG08	G082731	P604996	P604997	Straight
FPG08	G080599	P604996	–	Straight
FPG08	G082710	P604996	P604997	90°
FPG08	G082755	P604996	–	90°



### What is UL?



UL is an American worldwide safety consulting and certification company. It maintains offices in 46 countries, and was established in 1894.

UL most notably aided in the public adoption of electricity. It now has hundreds of standards covering a wide range of products.

UL has certified that the Donaldson air cleaners listed in the table above meet specifications for UL558, which covers the fire safety aspects of industrial trucks with internal combustion engines. These air cleaners have been specifically verified as backfire deflectors.

Please contact Donaldson for UL Listed FPG Air Cleaner availability.

This servicing information is provided as a best practices guide. It is not intended to replace or supersede the service instructions supplied by your engine or vehicle manufacturer.

## 1 Check the Restriction

Replace the filter only when the restriction level has reached the maximum recommended by the engine or equipment manufacturer or on a regular service schedule.



## 2 Clean Out the Vacuator™ Valve

If your air cleaner is equipped with a Vacuator™ Valve, visually check and physically squeeze it. Make sure the valve is flexible and not inverted, damaged or plugged.

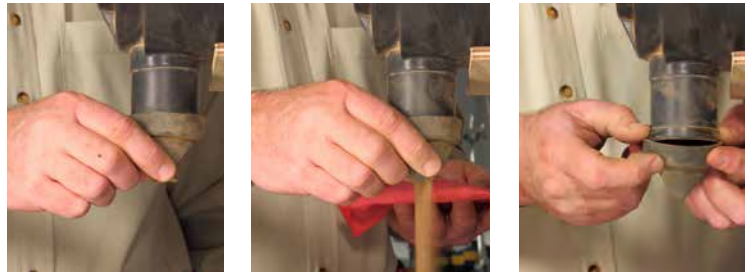

## 3 Remove the Primary filter

Shut off the engine. Unfasten or unlatch the service cover. For the FPG Alexin™ models, the cover is unlocked with a yellow "finger," twisted to the left and removed from the filter housing.

The RadialSeal™ filter fits tightly over the outlet tube and there will be some initial resistance, similar to breaking the seal on a jar. Gently move the end of the filter back and forth to break the seal, then rotate while pulling straight out. Avoid knocking the filter against the housing.



## 4 Visually Check the Safety Filter and Clean Both Surfaces of the Outlet Tube

If your air cleaner has a safety filter, visually check it while in place for signs of damage. Do not remove the safety filter unless it is damaged or due for replacement. Also verify that the safety filter is properly seated in the housing.

The safety filter should be replaced every three primary filter changes. Use a clean damp cloth to wipe both the filter sealing surface and the inside of the outlet tube. Ensure that the outlet tube sealing area is undamaged.

Contaminant on the sealing surface could hinder an effective seal and cause leakage. If the safety filter is to be replaced, avoid leaving the outlet tube exposed to the air. If there is to be a delay in installing the new safety filter, cover the air cleaner outlet tube to avoid admitting any dust.



*Continued on next page*



## 5 Inspect the Old Filter

Inspect the old filter for any signs of leaks. A streak of dust on the clean side of the filter is a telltale sign. Eliminate any source of air leaks before installing the new primary filter.

## 6 Inspect the New Filter

Inspect the new filter for any damage that may have occurred through mishandling. NEVER install a damaged filter. Visually check the inside of the open end, which is the sealing area.

Do not wipe the filter RadialSeal™ sealing area. Donaldson RadialSeal™ filters have an invisible dry lubricant on the seal to aid installation.



## 7 Insert the New Filter

First, if you're servicing the safety filter at this change-out, seat it properly into position before installing the primary filter. Insert new filters carefully. Seat the primary filter by hand, making certain it is inserted completely into the air cleaner housing. To complete a tight seal, apply pressure by hand at the outer rim of the filter, not the flexible center.

No cover pressure is required to hold the seal in place and you should NEVER use the service cover to apply pressure. This could damage the housing and fasteners and void the warranty. If the service cover presses against the filter before the cover is fully in place, remove the cover. With the cover off, push the filter farther into the air cleaner by hand and then the cover will go on with no extra force. Once the filter is in place, secure the service cover.

For FPG Alexin™ models, twist the cover to the right until it stops, then push the yellow "finger" in to lock.



*If you perform filter maintenance service on a schedule versus using service indicators, you may want to write the service date on the end cap of both filters.*

## 8 Check Connectors for Tight Fit

Make sure service indicators are reset and in proper working order. Check that all mounting bands, clamps, bolts, and connections in the entire air cleaner system are tight. Check for holes in piping and repair or replace as needed. Any leaks in the intake piping will admit dust directly to the engine. Reset the filter service indicator.





## Superior Protection for Larger Engines

### RadialSeal™ Sealing Technology Means Reliable Filtration and Quicker Service

The Donaldson two-stage FRG RadialSeal™ air cleaners provide improved reliability, better durability and reduced weight compared to axial seal style air cleaner designs. Choose from more than 20 air cleaners that work in airflow ranges of 82 to 1600 cfm.

### Two-Stage Filtration

Both Style A and B have an integral pre-cleaning stage that separates up to 85% of the incoming dust. The primary filter stops the rest, resulting in engine air that is 99.99% free of dust.

**Try PowerPleat™ for 11" Style B and 13" Style B. See page 53.**



Donaldson FRG Air Cleaners and Duramax hydraulics filters deliver superior filtration to pump-and-engine rigs used in the oil and gas industry.



The two-stage FRG Air Cleaner in operation on a Prentice 490 Skidder.



The FRG Air Cleaner on this Tyler Ag Sprayer eliminates 99.99% of the dirt from the engine airstream, while providing up to 945 cfm airflow to the engine.





## Durable, Vibration Resistant Variety of Sizes in Two Separate Housing Styles

### Applications

- Horizontal installation
- Medium and heavy dust environments
- **Style A** — From 82 to 795 cfm airflow throughput per air cleaner in body diameters ranging from 5" to 16" (127 – 406mm)
- **Style B** — From 270 to 1390 cfm airflow throughput per air cleaner in body diameters ranging from 10" to 18" (254 – 457mm)

### Ideal for

- Construction equipment
- Agricultural machinery
- Mining equipment
- Off-highway vehicles

### Air Cleaner Features

- Two-stage filter system: the first stage removes up to 85% of incoming dust
  - The first stage in the Style A uses the angled vanes on the primary filter
  - The first stage in the Style B has a tangential air inlet
- Inlet on side, outlet on end (G flow)
- Already tapped to accept filter service indicator
- Vacuator™ Valve automatically releases the pre-cleaned dust
- Recommended Vacuator Valve orientation angle is  $\pm 30^\circ$
- Durable, long-lasting finish
  - Style A housing is metal and coated with a black, corrosion- and chemical-resistant polymer paint (service cover is accessed with clamp and bolt)
  - Style B is comprised of two materials: injection molded, high strength polymer service cover and a metal body (the service cover is accessed by latches)
- Mounting the unit directly to the engine is not recommended; excessive engine vibration can cause premature air cleaner structural failure

#### FRG Style A

The FRG Style A series replaces Donaldson's obsolete FHG series in size and airflow capacity.



While it looks like an axial seal air cleaner on the outside, this new style housing is equipped with a RadialSeal™ style primary filter and an optional safety filter. Easy to service; one wing-bolt clamp to undo to access filter(s).

#### FRG Style B

The FRG Style B series replaces Donaldson's obsolete FTG series in size and airflow capacity.



Injection-molded endcap, made of specially-engineered resins for high strength and durability, serves as the service cover. Filter change out is easier than ever — just unsnap the latches to access the filter.

### Filter Features

The RadialSeal™ filter inside the air cleaner is also quite different from Axial filters. Its one-piece, molded urethane endcaps encase the filter media and liners, thereby reducing the number of components and increasing sealing reliability.



The inside surface of the filter's open end is the sealing surface, which eliminates the glued-on gasket found on the metal end cap of Axial filters. For added engine protection during filter service, consider a model with a safety filter.

High efficiency, extended service, Donaldson Blue® filters are available on some models (see service parts list on pages 134 and 135 for part numbers)

### FRG Mounting Bands

- Two mounting bands are required for proper FRG installation (see service parts listing in this section).
- Durable, corrosion resistant, galvanized steel construction.
- Engineered and tested to resist the adverse effects of vibration.
- Mounting band feet are designed to continuously ensure maximum torque pressure.
- Dimensional information for mounting bands can be found in the accessories section.



### Accessories

Donaldson intake accessories for your FRG Air Cleaner can help overcome or prevent various problems. For instance:

- If the installed air cleaner will be exposed to rain, snow or debris, an **inlet cap** can prevent moisture ingestion.
- A **filter service indicator** measures the airflow restriction across the filter and indicates when to replace the filter (see Accessories section of this catalog).
- **Mounting bands** for FRGs must be ordered separately.

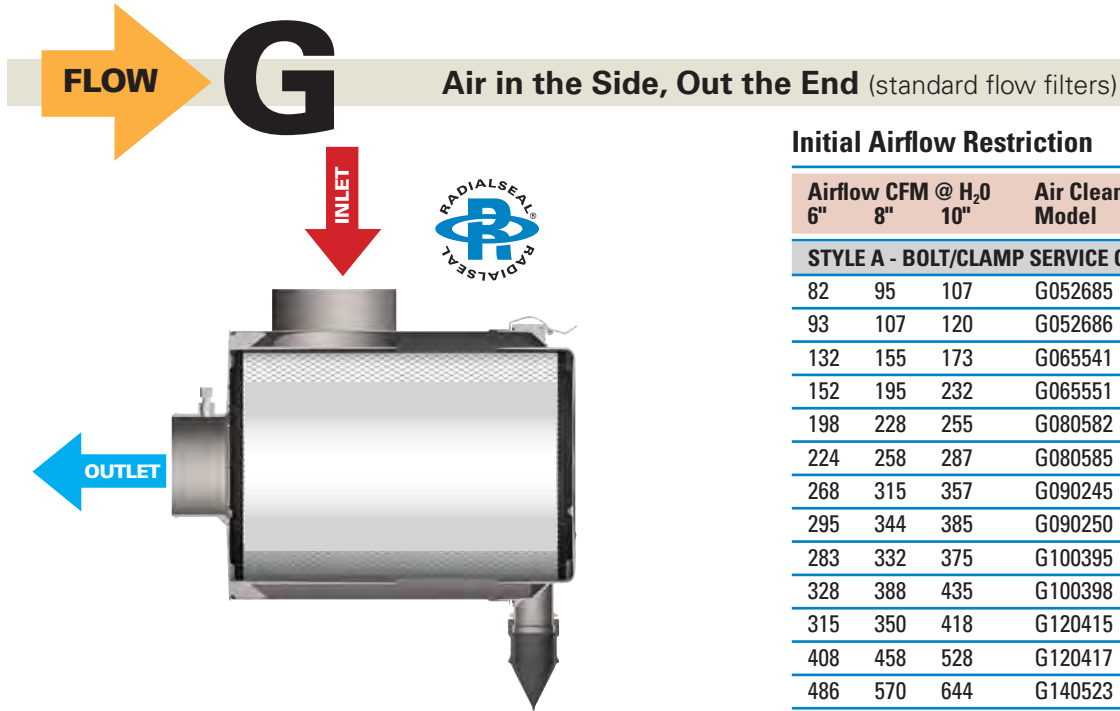

**Initial Airflow Restriction**

Airflow CFM @ H <sub>2</sub> O		Air Cleaner Model	Weight		
6"	8"		lbs	kg	
<b>STYLE A - BOLT/CLAMP SERVICE COVER</b>					
82	95	107	G052685	5.5	2.5
93	107	120	G052686	5.2	2.4
132	155	173	G065541	7.6	3.4
152	195	232	G065551	7.1	3.2
198	228	255	G080582	11.0	5.0
224	258	287	G080585	10.5	4.8
268	315	357	G090245	13.1	5.9
295	344	385	G090250	12.1	5.5
283	332	375	G100395	30.1	13.7
328	388	435	G100398	28.6	13.0
315	350	418	G120415	26.5	12.0
408	458	528	G120417	28.1	12.7
486	570	644	G140523	34.9	15.8
560	657	742	G140526	33.3	15.1
590	700	795	G160679	41.7	18.9
<b>STYLE B - LATCH SERVICE COVER</b>					
270	305	340	G100297	12.0	5.4
300	360	400	G110214	13.1	5.9
370	430	490	G110206	17.5	8.0
440	510	570	G130107	20.6	9.3
520	590	655	G130097	25.0	11.4
715	805	945	G150092	30.0	13.6
1040	1230	1390	G180031	44.0	20.0

**When Selecting an Air Cleaner . . .**

Determine the airflow requirements of your engine, then find the corresponding cfm airflow in the table at right. The restriction numbers (shown in inches of water) indicate the approximate initial restriction of each model air cleaner at that cfm. If there are two air cleaner models that fit your parameters, choosing the one with the lower restriction will provide longer filter service life. When calculating total initial restriction of the entire air intake system, include the restriction caused by ducting, elbows, and pre-cleaners. See pages 257-258 for ducting restriction estimates.

**FRG Air Cleaner Performance Curves (Restriction & Dust Capacity)\***

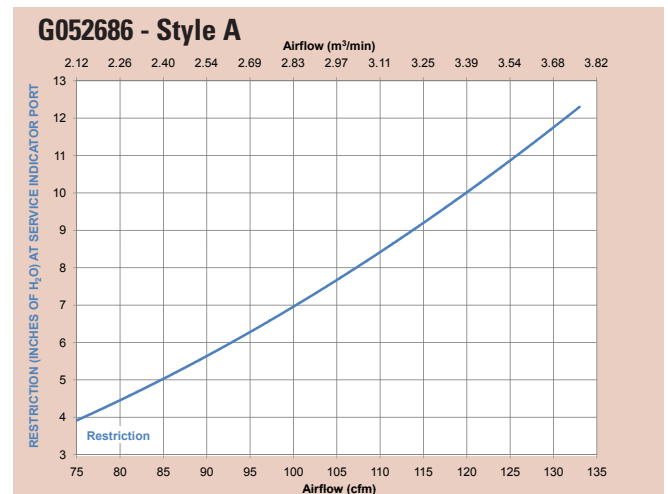
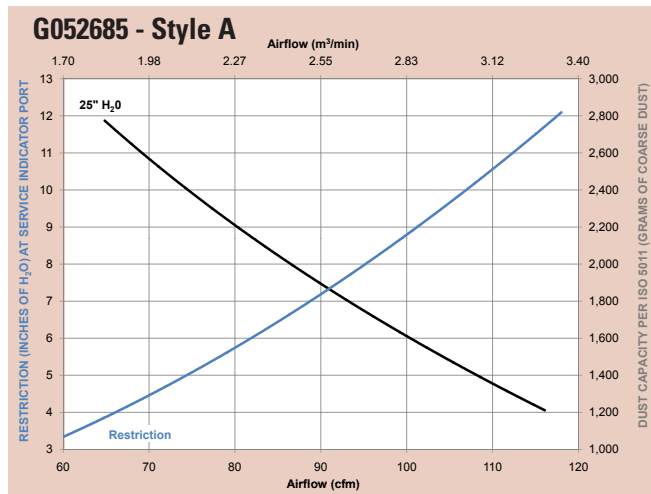

\*Results generated using laboratory testing pursuant to ISO5011. Actual performance during use may vary depending on multiple factors, including specific product configuration, external conditions and application.



continued – FRG Air Cleaner Performance Curves (Restriction & Dust Capacity)

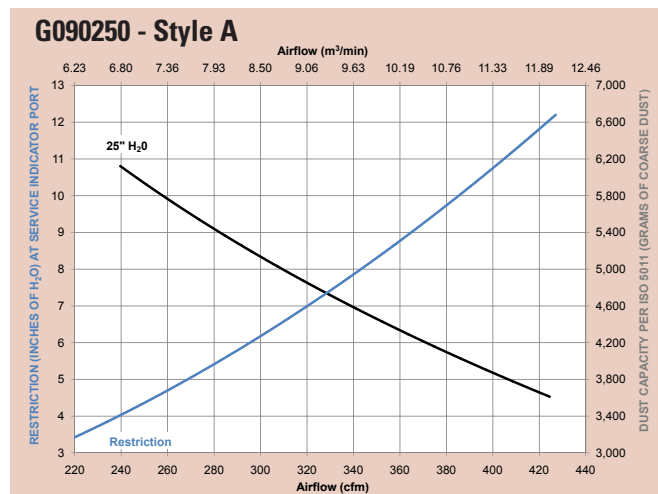
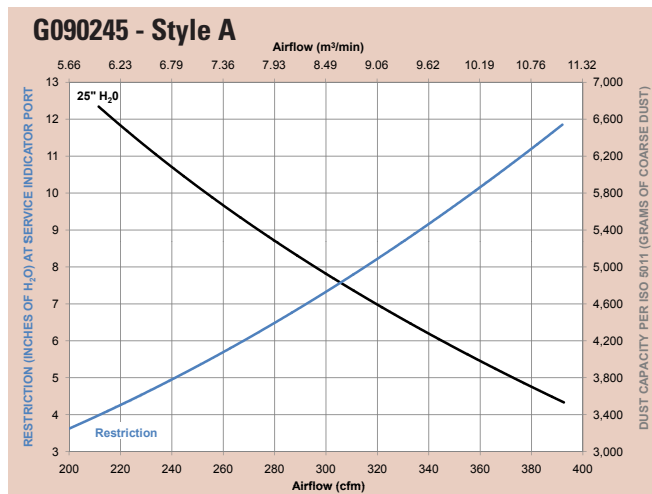
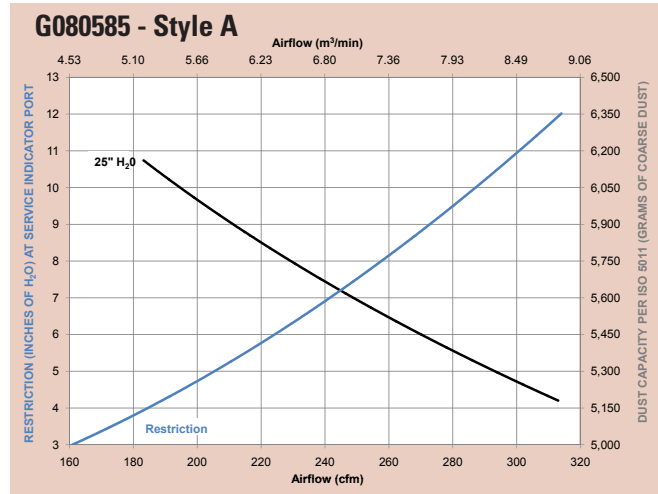
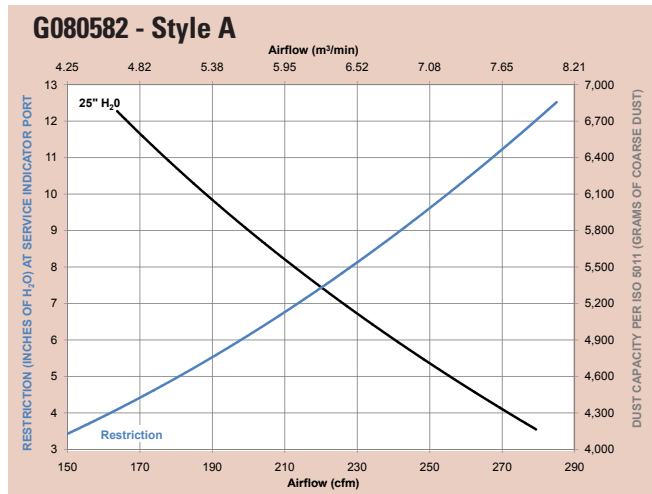
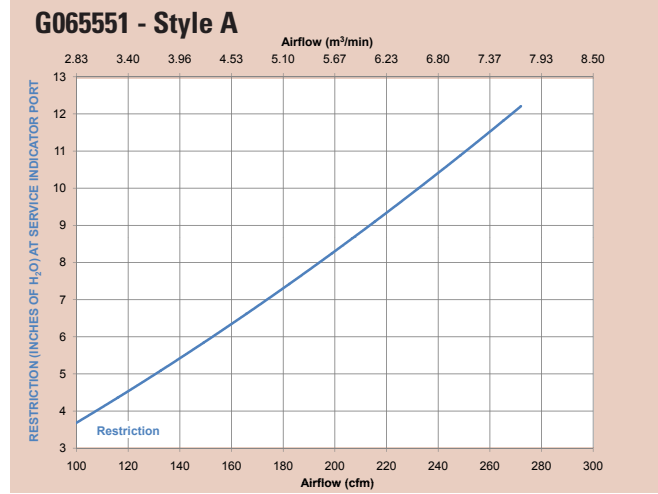
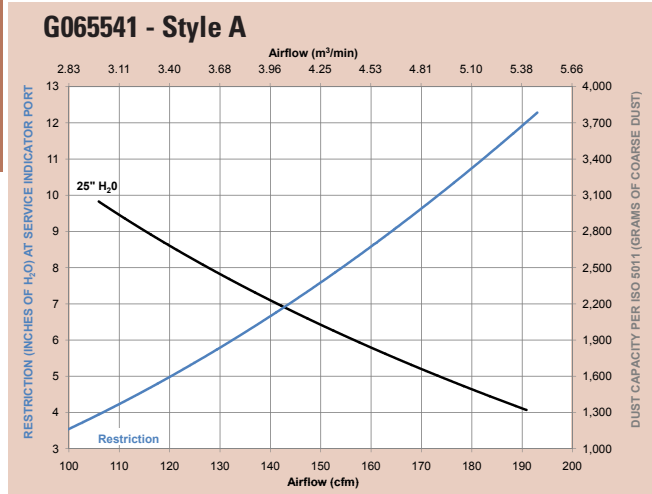

continued — FRG Air Cleaner Performance Curves (Restriction & Dust Capacity)

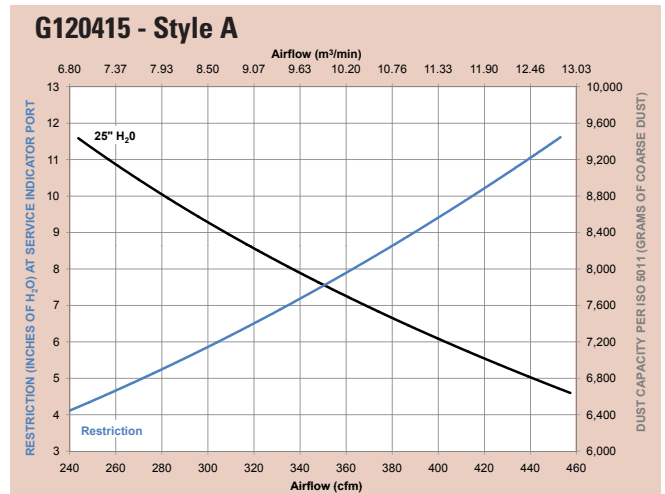
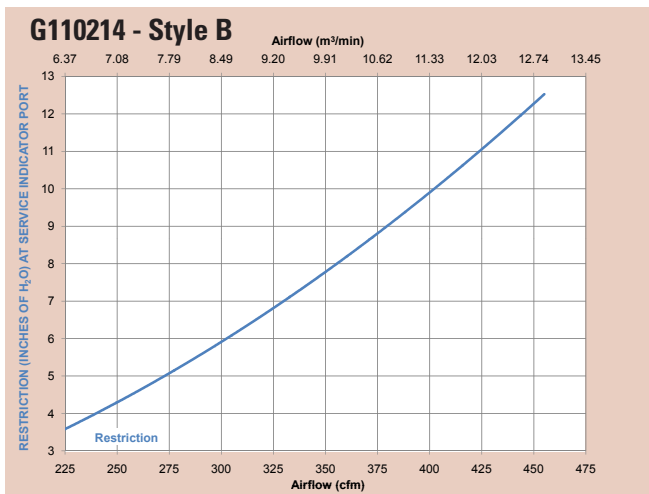
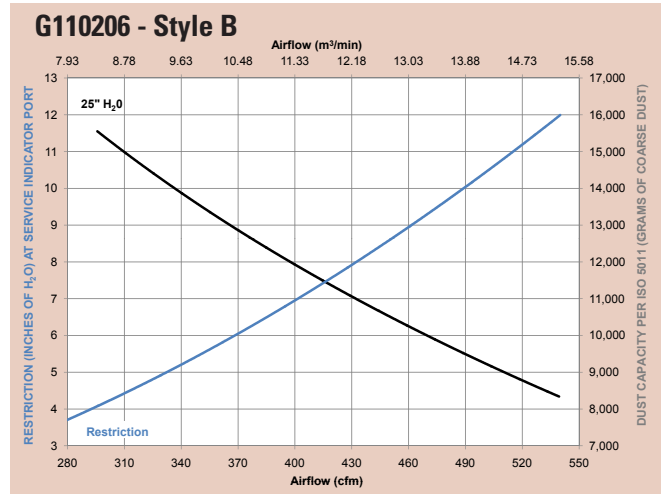
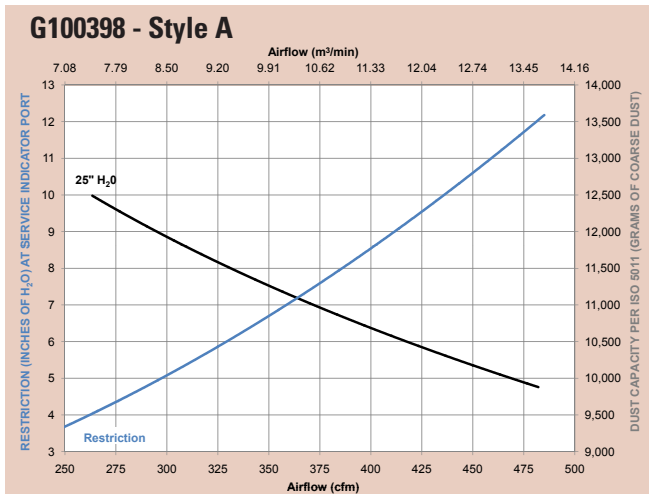
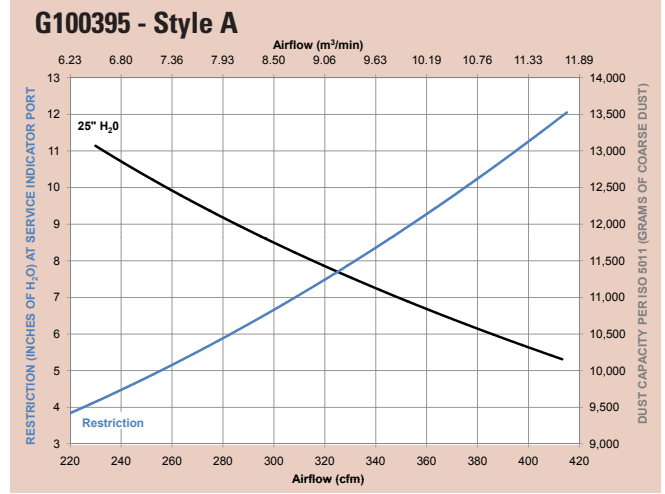





continued — FRG Air Cleaner Performance Curves (Restriction & Dust Capacity)

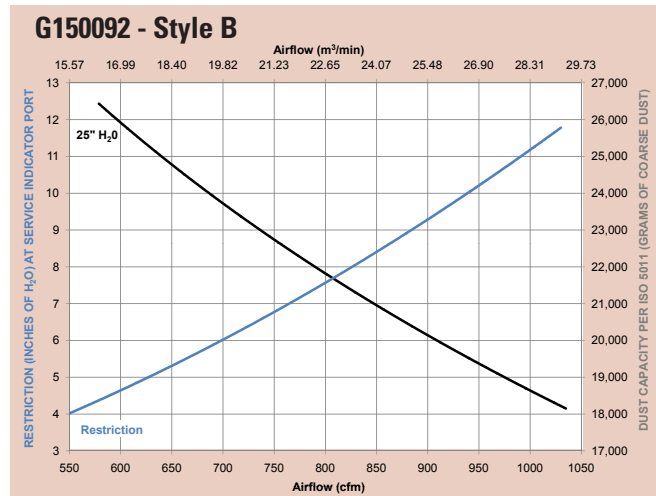
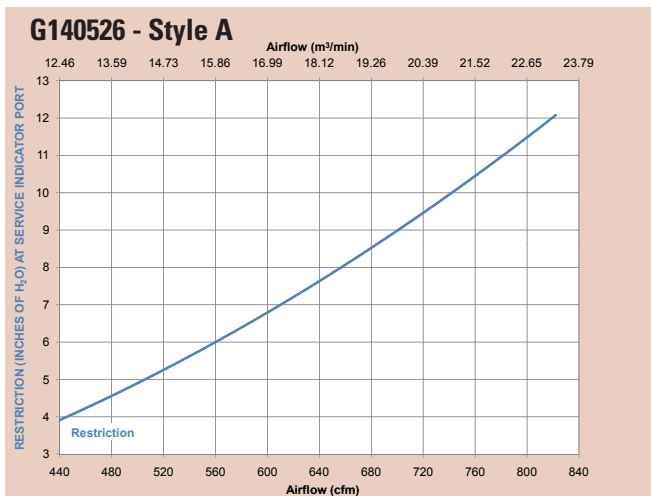
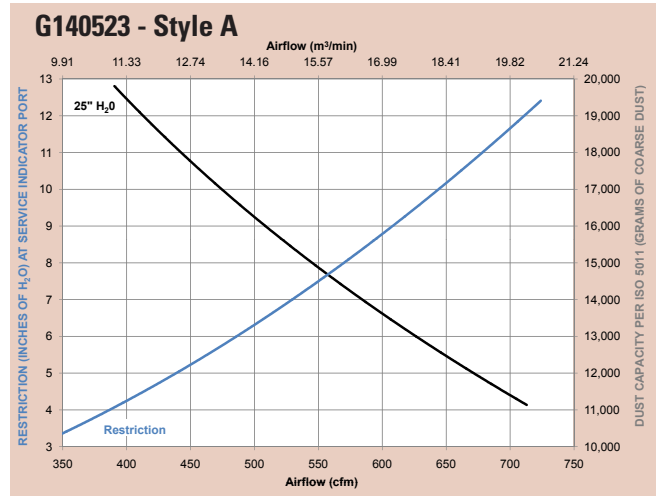
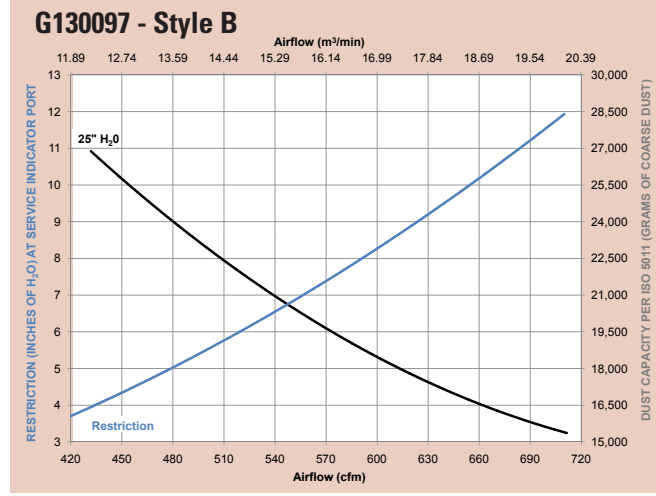
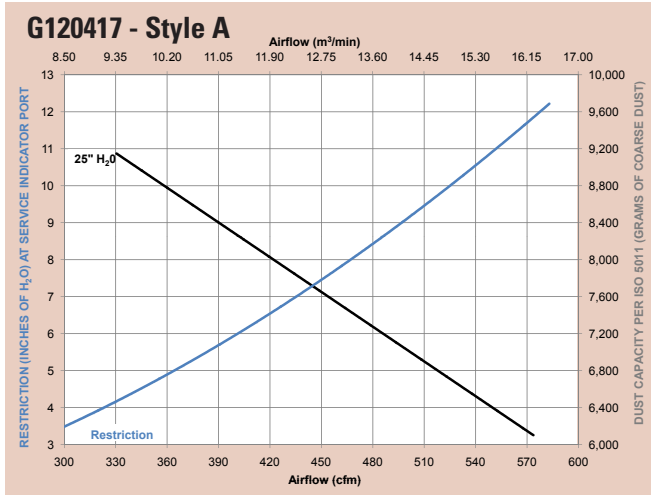

continued — FRG Air Cleaner Performance Curves (Restriction & Dust Capacity)

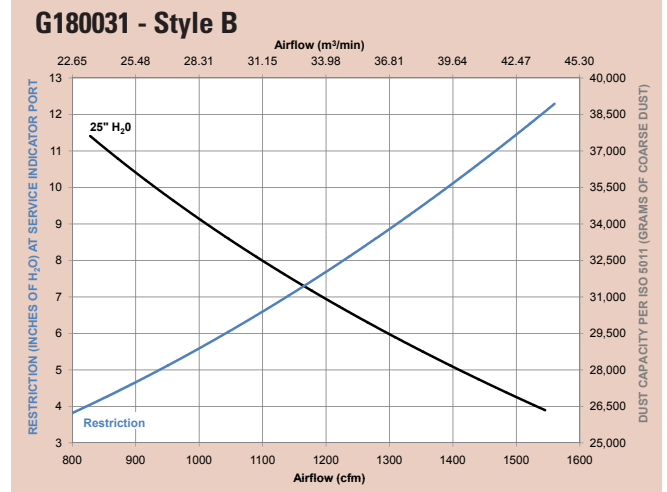
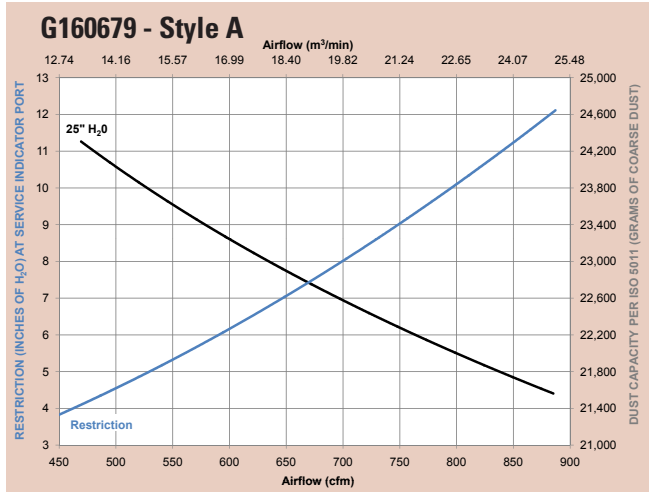

**FRG Specification Illustrations**

Style B — Latch Service Cover (Style A on next page)

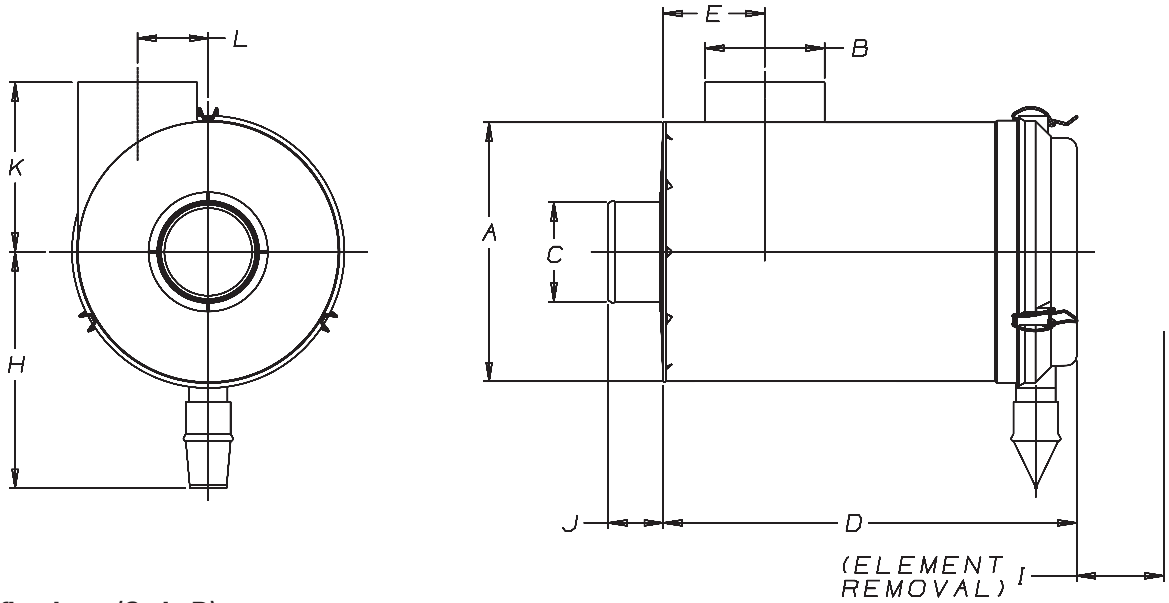

**FRG Specifications (Style B)**

Air Cleaner Models	Body Diameter (A)		Inlet Diameter (B)		Outlet Diameter (C)		Housing Length (D)		Inlet Location (E)		Center Line to Valve (H)		Service Clearance (I)		Outlet Length (J)		Inlet Length (K)		Offset Inlet Location (L)	
	in	mm	in	mm	in	mm	in	mm	in	mm	in	mm	in	mm	in	mm	in	mm	in	mm
<b>STYLE B - LATCH SERVICE COVER</b>																				
G100297	10.2	259	4.5	114	4.0	102	16.93	430	3.54	90	10.63	270	15.00	373	2.59	66	8.07	205	2.81	72
G110214	11.0	279	5.0	127	4.5	114	13.78	350	4.13	105	10.81	275	17.00	428	2.64	67	7.50	191	2.96	75
G110206	11.0	279	5.0	127	4.5	114	19.28	490	4.13	105	10.81	275	17.00	428	2.64	67	7.50	191	2.96	75
G130107	13.0	330	6.0	152	5.0	127	16.73	425	5.22	132	11.85	301	18.00	450	2.64	67	8.50	216	3.54	90
G130097	13.0	330	6.0	152	5.0	127	20.87	530	5.22	132	11.85	301	18.00	450	2.64	67	8.50	216	3.54	90
G150092	15.0	381	7.0	178	6.0	152	20.87	530	5.51	140	13.31	338	19.00	482	2.75	70	9.50	241	4.03	102
G180031	18.0	457	8.0	203	8.0	203	25.60	650	5.04	128	15.80	402	28.62	600	3.35	85	11.42	290	5.05	128



## FRG Specification Illustrations

### Style A — Bolt/Clamp Service Cover

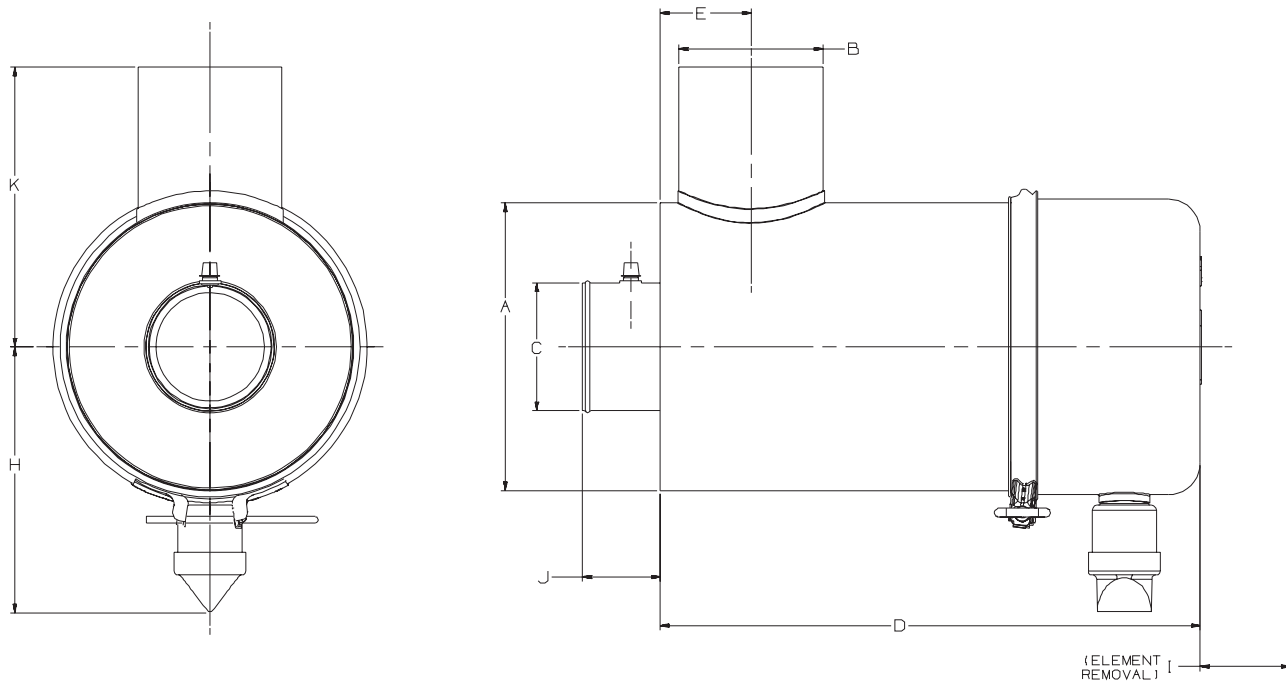

### FRG Specifications (Style A)

Air Cleaner Models	Body Diameter (A)		Inlet Diameter (B)		Outlet Diameter (C)		Housing Length (D)		Inlet Location (E)		Center Line to Valve (H)		Service Clearance (I)		Outlet Length (J)		Inlet Length (K)	
	in	mm	in	mm	in	mm	in	mm	in	mm	in	mm	in	mm	in	mm	in	mm
<b>STYLE A - BOLT/CLAMP SERVICE COVER</b>																		
G052685	5.25	133	2.50	64	2.50	64	14.76	375	2.06	52	6.36	162	9.80	249	2.30	58	4.97	126
G052686	5.25	133	2.50	64	2.50	64	14.76	375	2.06	52	6.36	162	9.80	249	2.30	58	4.97	126
G065541	6.55	166	3.00	76	3.00	76	15.44	392	1.92	49	6.28	160	12.31	313	2.22	56	6.38	162
G065551	6.55	166	3.00	76	3.00	76	15.44	392	1.92	49	6.28	160	12.31	313	2.22	56	6.38	162
G080582	8.00	203	3.75	95	3.50	89	15.84	402	2.38	60	7.96	202	12.44	316	2.46	62	7.25	184
G080585	8.00	203	3.75	95	3.50	89	15.84	402	2.38	60	7.96	202	12.44	316	2.46	62	7.25	184
G090245	9.00	229	4.50	114	4.00	102	16.90	429	2.84	72	8.27	210	16.90	429	2.43	62	8.75	222
G090250	9.00	229	4.50	114	4.00	102	16.90	429	2.84	72	8.27	210	16.90	429	2.43	62	8.75	222
G100395	10.19	259	4.50	114	5.00	127	21.03	534	3.38	86	8.96	228	13.06	332	2.10	53	8.09	205
G100398	10.19	259	4.50	114	5.00	127	21.03	534	3.38	86	8.96	228	13.06	332	2.10	53	8.09	205
G120415	12.00	305	5.00	127	5.00	127	19.06	484	4.69	119	9.62	244	9.10	231	2.28	58	8.92	227
G120417	12.00	305	5.00	127	5.00	127	19.06	484	4.69	119	9.62	244	9.10	231	2.28	58	8.92	227
G140523	14.00	356	6.00	152	6.00	152	22.06	560	5.28	134	10.72	272	12.10	307	2.26	57	10.12	257
G140526	14.00	356	6.00	152	6.00	152	22.06	560	5.28	134	10.72	272	12.10	307	2.26	57	10.12	257
G160679	16.00	406	7.00	178	7.00	178	24.04	611	5.76	146	11.72	298	14.10	358	2.29	58	12.00	305

**FRG Service Parts**

**Style A — Bolt/Clamp Service Cover**

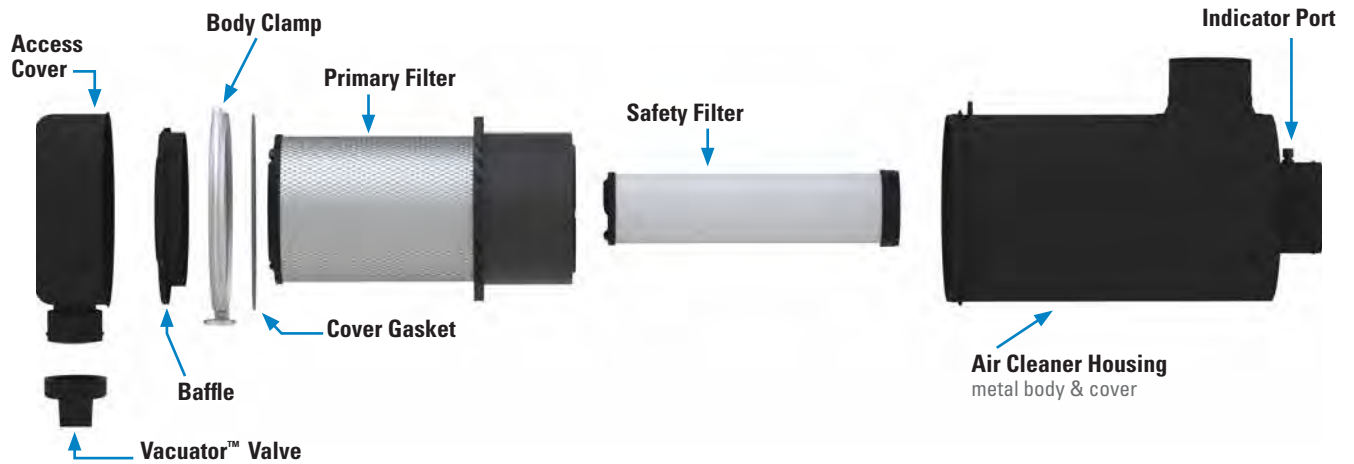

**Style B — Latch Service Cover**

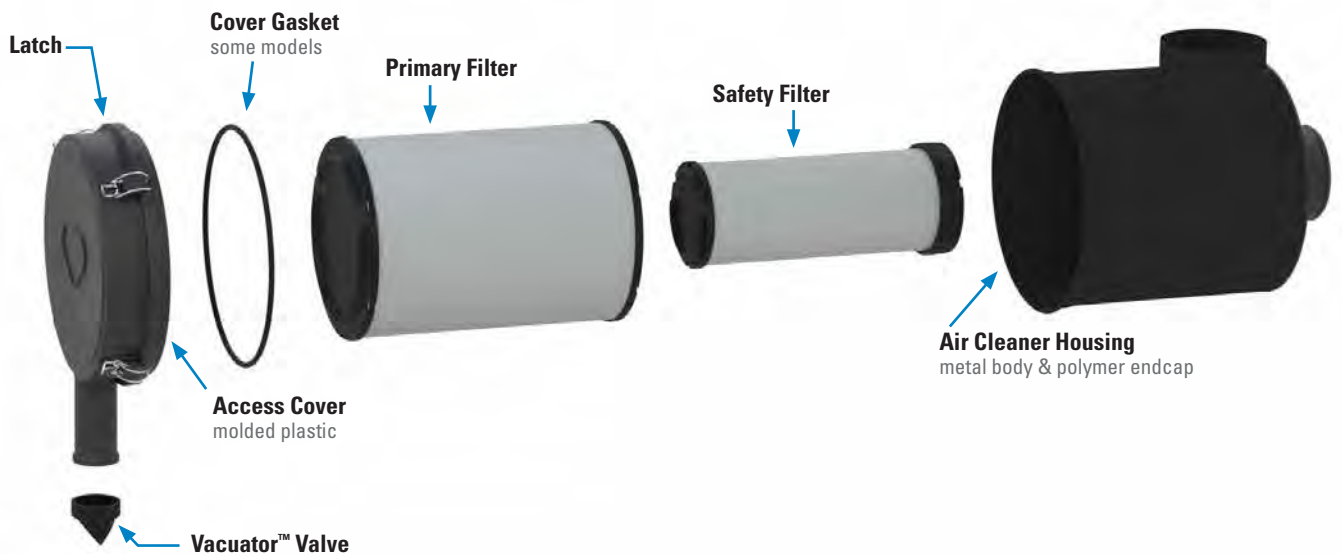

**FRG Service Parts & Accessories**

**G052685 FRG Style A**

Clamp .....	P002904
Cover .....	P120279
Elbow, 45° .....	P105543
Elbow, 90° .....	P105531
Filter, primary .....	P600043 .....3
Filter, safety .....	P600047 .....3
Informer™ indicator 25" H <sub>2</sub> O .....	X002277
Inlet hood, plastic .....	H001378
Mounting band .....	P002348 .....2
Mounting bands, metal .....	P002348
Outlet band clamp .....	P148339
Vacuator™ Valve .....	P158914

**G052686 FRG Style A**

Clamp .....	P002904
Cover .....	P120279
Elbow, 45° .....	P105543
Elbow, 90° .....	P105531
Filter, primary .....	P600043 .....3
Filter, safety (optional) .....	P600047
Informer™ indicator 25" H <sub>2</sub> O .....	X002277
Inlet hood, plastic .....	H001378
Mounting band .....	P002348 .....2
Outlet band clamp .....	P148339
Vacuator™ Valve .....	P158914

**SERVICE PARTS NOTES:**

- 2 = Two required for proper installation
- 3 = Shipped with air cleaner initially
- 8 = Cover assembly includes latches but no Vacuator™ Valve
- Donaldson Blue® = High Efficiency, Extended Service



**G065541 FRG Style A**

Clamp	P002940
Cover	P522133
Elbow, 45°	P105544
Elbow, 90°	P105532
Elbow, 90° reducing	P123462
Filter, primary	P549271 .....3
Filter, safety	P549277 .....3
Hump hose	P105608
Informer™ indicator 25" H <sub>2</sub> O	X002277
Inlet hood, plastic	H001379
Mounting band	P007191 .....2
Outlet band clamp	P148341
Vacuator™ Valve	P158914

**G065551 FRG Style A**

Clamp	P002940
Cover	P522133
Elbow, 45°	P105544
Elbow, 90°	P105532
Elbow, 90° reducing	P123462
Filter, primary	P549271 .....3
Filter, safety (optional)	P549277
Hump hose	P105608
Informer™ indicator 25" H <sub>2</sub> O	X002277
Inlet hood, plastic	H001379
Mounting band	P007191 .....2
Outlet band clamp	P148341
Vacuator™ Valve	P158914

**G080582 FRG Style A**

Clamp	P003951
Cover	P600321
Elbow, 45°	P109331
Elbow, 90°	P114318
Filter, primary-Donaldson Blue®	DBA5223
Filter, primary	P601437 .....3
Filter, safety	P601476 .....3
Hump hose	P114319
Informer™ indicator 25" H <sub>2</sub> O	X002277
Inlet hood, plastic	H000466
Mounting band	P004307 .....2
Outlet band clamp	P148342
Vacuator™ Valve	P158914

**G080585 FRG Style A**

Cover	P600321
Elbow, 45°	P109331
Elbow, 90°	P114318
Filter, primary-Donaldson Blue®	DBA5223
Filter, primary	P601437 .....3
Filter, safety (optional)	P601476
Hump hose	P114319
Informer™ indicator 25" H <sub>2</sub> O	X002277
Inlet hood, plastic	H000466
Mounting band	P004307 .....2
Outlet band clamp	P148342
Vacuator™ Valve	P158914

**G090245 FRG Style A**

Clamp	P102025
Cover	P600657
Elbow, 45°	P105545
Elbow, 90°	P105533
Elbow, 90° reducing	P121482
Filter, primary-Donaldson Blue®	DBA5224
Filter, primary	P601280 .....3
Filter, safety	P601286 .....3
Hump hose	P105609
Informer™ indicator 25" H <sub>2</sub> O	X002277
Inlet hood, metal	H000170
Inlet hood, plastic	H000468
Mounting band	P004073 .....2
Outlet band clamp	P148343
Vacuator™ Valve	P158914

**G090250 FRG Style A**

Cover	P600657
Elbow, 45°	P105545
Elbow, 90°	P105533
Elbow, 90° reducing	P121482
Filter, primary-Donaldson Blue®	DBA5224
Filter, primary	P601280 .....3
Filter, safety (optional)	P601286
Hump hose	P105609
Informer™ indicator 25" H <sub>2</sub> O	X002277
Inlet hood, metal	H000170
Inlet hood, plastic	H000468
Mounting band	P004073 .....2
Outlet band clamp	P148343
Vacuator™ Valve	P158914

**G100297 FRG Style B**

Cover	P538200 .....8
Elbow, 45°	P105545
Elbow, 90°	P105533
Elbow, 90° reducing	P121482
Filter, primary-Donaldson Blue®	DBA5228
Filter, primary	P781039 .....3
Filter, safety	P777639 .....3
Gasket, cover	P537308
Hump hose	P105609
Informer™ indicator 25" H <sub>2</sub> O	X002277
Inlet hood, plastic	H000468
Latch	P777366
Mounting band	P004076 .....2
Outlet band clamp	P148343
Vacuator™ Valve	P776008

**G100395 FRG Style A**

Baffle, metal	P602211
Clamp	P106071
Dust cup/cover	P103827
Elbow, 45°	P109021
Elbow, 90°	P107844
Elbow, 90° reducing	P143895
Filter, primary-Donaldson Blue®	DBA5222
Filter, primary	P601790 .....3
Filter, safety (optional)	P777639 .....3
Hump hose	P105610
Informer™ indicator 25" H <sub>2</sub> O	X002277
Inlet hood, metal	H000170
Inlet hood, plastic	H000468
Mounting band	P004076 .....2
O-ring	P101401
Outlet band clamp	P148345
Vacuator™ Valve	P103198

**G100398 FRG Style A**

Baffle, metal	P602211
Clamp	P106071
Dust cup/cover	P103827
Elbow, 45°	P109021
Elbow, 90°	P107844
Elbow, 90° reducing	P143895
Filter, primary-Donaldson Blue®	DBA5222
Filter, primary	P601790 .....3
Filter, safety (optional)	P777639
Hump hose	P105610
Informer™ indicator 25" H <sub>2</sub> O	X002277
Inlet hood, metal	H000170
Inlet hood, plastic	H000468
Mounting band	P004076 .....2
Mounting bands, metal	P004076
O-ring	P101401
Outlet band clamp	P148345
Vacuator™ Valve	P103198

**G110206 FRG Style B**

Cover	P538452 .....8
Elbow, 45°	P114316
Elbow, 90°	P113733
Filter, primary-Donaldson Blue®	DBA5105
Filter, primary - SM	P532966 .....3
Filter, safety	P533781 .....3
Gasket, cover	P526676
Hump hose	P114317
Informer™ indicator 25" H <sub>2</sub> O	X002277
Inlet hood, metal	H000165
Inlet hood, plastic	H000469
Latch	P536439
Mounting band	P004079 .....2
Outlet band clamp	P148344
Vacuator™ Valve	P158914

**G110214 FRG Style B**

Cover	P538452 .....8
Elbow, 45°	P114316
Elbow, 90°	P113733
Filter, primary-Donaldson Blue®	DBA5230
Filter, primary	P536457 .....3
Filter, safety	P536492 .....3
Gasket, cover	P526676
Hump hose	P114317
Informer™ indicator 25" H <sub>2</sub> O	X002277
Inlet hood, metal	H000170
Inlet hood, plastic	H000468
Latch	P536439
Mounting band	P004079 .....2
Outlet band clamp	P148344
Vacuator™ Valve	P158914



## G120415 FRG Style A

Baffle, metal.....	P106329
Clamp.....	P121067
Dust cup/cover.....	P109296
Elbow, 45°.....	P109021
Elbow, 90°.....	P107844
Elbow, 90° reducing.....	P143895
Filter, primary-Donaldson Blue®... DBA5231	
Filter, primary.....	P601767 .....3
Filter, safety.....	P601774 .....3
Hump hose.....	P105610
Informer™ indicator 25" H <sub>2</sub> O.....	X002277
Inlet hood, metal.....	H000165
Inlet hood, plastic.....	H000469
Mounting band.....	H000349 .....2
O-ring.....	P017804
Outlet band clamp.....	P148345
Vacuator™ Valve.....	P103198

## G120417 FRG Style A

Baffle, metal.....	P106329
Clamp.....	P121067
Dust cup/cover.....	P109296
Elbow, 45°.....	P109021
Elbow, 90°.....	P107844
Elbow, 90° reducing.....	P143895
Filter, primary-Donaldson Blue®... DBA5231	
Filter, primary.....	P601767 .....3
Filter, safety (optional).....	P601774
Hump hose.....	P105610
Informer™ indicator 25" H <sub>2</sub> O.....	X002277
Inlet hood, metal.....	H000165
Inlet hood, plastic.....	H000469
Mounting band.....	H000349 .....2
O-ring.....	P017804
Outlet band clamp.....	P148345
Vacuator™ Valve.....	P103198

## G130097 FRG Style B

Cover.....	P538259 .....8
Elbow, 45°.....	P109021
Elbow, 90°.....	P107844
Elbow, 90° reducing.....	P143895
Filter, primary-Donaldson Blue®... DBA5221	
Filter, primary.....	P537876 .....3
Filter, safety.....	P537877 .....3
Gasket, cover.....	P537699
Hump hose.....	P105610
Informer™ indicator 25" H <sub>2</sub> O.....	X002277
Inlet hood, metal.....	H000275
Inlet hood, plastic.....	H000606
Latch.....	P776033
Mounting band.....	P013722 .....2
Outlet band clamp.....	P148345
Vacuator™ Valve.....	P776008

## G130107 FRG Style B

Cover.....	P538259 .....8
Elbow, 45°.....	P109021
Elbow, 90°.....	P107844
Elbow, 90° reducing.....	P143895
Filter, primary-Donaldson Blue®... DBA5220	
Filter, primary.....	P532503 .....3
Filter, safety.....	P532504 .....3
Gasket, cover.....	P537699
Hump hose.....	P105610
Informer™ indicator 25" H <sub>2</sub> O.....	X002277
Inlet hood, metal.....	H000275
Inlet hood, plastic.....	H000606
Latch.....	P776033
Mounting band.....	P013722 .....2
Outlet band clamp.....	P148345
Vacuator™ Valve.....	P776008

## G140523 FRG Style A

Baffle, metal.....	P106771
Clamp.....	P100866
Dust cup/cover.....	P109297
Elbow, 45°.....	P105547
Elbow, 90°.....	P105535
Filter, primary-Donaldson Blue®... DBA5220	
Filter, primary.....	P532503 .....3
Filter, safety.....	P532504 .....3
Hump hose.....	P105612
Informer™ indicator 25" H <sub>2</sub> O.....	X002277
Inlet hood, metal.....	H000275
Inlet hood, plastic.....	H000606
Mounting band.....	H000350 .....2
O-ring.....	P017335
Outlet band clamp.....	P148347
Vacuator™ Valve.....	P103198

## G140526 FRG Style A

Baffle, metal.....	P106771
Clamp.....	P100866
Dust cup/cover.....	P109297
Elbow, 45°.....	P105547
Elbow, 90°.....	P105535
Filter, primary-Donaldson Blue®... DBA5220	
Filter, primary.....	P532503 .....3
Filter, safety (optional).....	P532504
Hump hose.....	P105612
Informer™ indicator 25" H <sub>2</sub> O.....	X002277
Inlet hood, metal.....	H000275
Inlet hood, plastic.....	H000606
Mounting band.....	H000350 .....2
O-ring.....	P017335
Outlet band clamp.....	P148347
Vacuator™ Valve.....	P103198

## G150092 FRG Style B

Cover.....	P777920 .....8
Elbow, 45°.....	P105547
Elbow, 90°.....	P105535
Filter, primary-Donaldson Blue®... DBA5116	
Filter, primary.....	P777868 .....3
Filter, safety.....	P777869 .....3
Hump hose.....	P105612
Informer™ indicator 25" H <sub>2</sub> O.....	X002277
Inlet hood, metal.....	H000339
Inlet hood, plastic.....	H000607
Latch.....	P776033
Mounting band.....	P016845 .....2
Outlet band clamp.....	P148347
Vacuator™ Valve.....	P776008

## G160679 FRG Style A

Baffle, metal.....	P106637
Clamp.....	P100789
Dust cup/cover.....	P106952
Elbow, 45°.....	P105548
Elbow, 90°.....	P105536
Filter, primary-Donaldson Blue®... DBA5229	
Filter, primary.....	P549523 .....3
Filter, safety.....	P549530 .....3
Hump hose.....	P105613
Informer™ indicator 25" H <sub>2</sub> O.....	X002277
Inlet hood, metal.....	H000339
Inlet hood, plastic.....	H000606
Mounting band.....	H000351 .....2
O-ring.....	P017336
Outlet band clamp.....	P148348
Vacuator™ Valve.....	P103198

## G180031 FRG Style B

Cover.....	P783185
Elbow, 45°.....	P112606
Elbow, 90°.....	P112605
Filter, primary-Donaldson Blue®... DBA5156	
Filter, primary.....	P781098 .....3
Filter, safety.....	P781102 .....3
Hump hose.....	P112608
Informer™ indicator 25" H <sub>2</sub> O.....	X002277
Inlet hood, plastic.....	H001053
Mounting band.....	H770037 .....2
Outlet band clamp.....	P629991
Vacuator™ Valve.....	P105220

### SERVICE PARTS NOTES:

- 2 = Two required for proper installation
- 3 = Shipped with air cleaner initially
- 7 = Included with each replacement filter
- 8 = Cover assembly includes latches, but no Vacuator Valve.

Donaldson Blue® = High Efficiency, Extended Service



This servicing information is provided as a best practices guide. It is not intended to replace or supersede the service instructions supplied by your engine or vehicle manufacturer.

### 1 Check the Restriction

Replace the filter only when the restriction level has reached the maximum recommended by the engine or equipment manufacturer or on a regular service schedule.



### 2 Remove the Primary Filter and check the Vacuator™ Valve

Shut off the engine. Unfasten or unlatch the service cover.

Because of its RadialSeal™, the filter fits tightly over the outlet tube and there will be some initial resistance, similar to breaking the seal on a jar. Gently move the end of the filter back and forth to break the seal then rotate while pulling straight out. Avoid knocking the filter against the housing.

If your air cleaner is equipped with a Vacuator™ Valve, visually check and physically squeeze it.

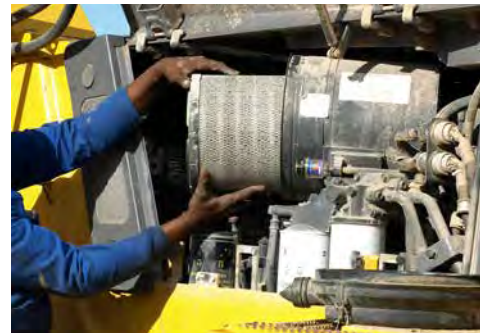

Make sure the valve is flexible and not inverted, damaged or plugged. Replace it if damaged or if it looks like any of these images. A damaged or missing vac valve will disrupt the designed flow of air through the air cleaner.

### 3 Visually Check the Safety Filter and Clean Both Surfaces of the Outlet Tube

If your air cleaner has a safety filter, visually check the safety filter in place for signs of damage. Do not remove the safety filter unless it is damaged or due for replacement. Also verify that the safety filter is properly seated in the housing.

The safety filter should be replaced every three primary filter changes. Use a clean damp cloth to wipe both the filter sealing surface and the inside of the outlet tube. Ensure that the outlet tube sealing area is undamaged.

Contaminant on the sealing surface could hinder an effective seal and cause leakage. If the safety filter is to be replaced, avoid leaving the outlet tube exposed to the air.

If there is to be a delay in installing the new safety filter, cover the air cleaner outlet tube to avoid admitting any dust.





## 4 Inspect the Old Filter

Inspect the old filter for any signs of leaks. A streak of dust on the clean side of the filter is a telltale sign. Eliminate any source of air leaks before installing the new primary filter.



## 5 Inspect the New Filter

Inspect the new filter for any damage that may have occurred through mishandling. NEVER install a damaged filter. Visually check the inside of the open end, which is the sealing area.

Do not wipe the filter RadialSeal™ area as the new Donaldson RadialSeal filter may have a dry lubricant on the seal to aid installation.



## 6 Insert the New Filter

First, if you're servicing the safety filter at this change-out, seat it properly into position before installing the primary filter. Insert new filters carefully. Seat the primary filter by hand, making certain it is inserted completely into the air cleaner housing. To complete a tight seal, apply pressure by hand at the outer rim of the filter, not the flexible center.

No cover pressure is required to hold the seal in place and one should NEVER use the service cover to apply pressure. This could damage the housing and fasteners and void the warranty. If the service cover presses against the filter before the cover is fully in place, remove the cover. With cover off, push the filter farther into the air cleaner by hand and then the cover will go on with no extra force. Once the filter is in place, secure the service cover.



Continued on next page





### 7 Check Inlet Hoods and Pre-Cleaners

Check any intake hoods and pre-cleaner devices during maintenance routines.

A missing inlet hood will significantly shorten filter life. If your unit had a hood or pre-cleaner originally, make sure you replace it. Check openings and tubes on pre-cleaners to make sure they are not plugged. Replace any units that are damaged. Damaged or dented units will not operate properly.



### 8 Check Connectors for Tight Fit

Make sure service indicators are reset and in proper working order.

Check that all mounting bands, clamps, bolts, and connections in the entire air cleaner system are tight.

Check for holes in piping, and repair or replace as needed.

Any leaks in the intake piping will admit dust directly to the engine.



## Under Hood Mount, Two-Stage Filtration For Large Construction & Mining Equipment

The FTG Cycloflow™ Air Cleaner is another two-stage air cleaner with a built-in pre-cleaner. This air cleaner has axial seal style filters. The FTG is typically mounted under hood with the service cover on the outside for access.

### Applications

- Allows 32-59 m<sup>3</sup>/min. airflow throughput per air cleaner
- Horizontal installation
- Sustained temperature tolerance: to 82 °C

### Ideal for

- Large industrial and construction equipment: crawler tractors, crane loaders, excavators and air compressors with large engines operating in severe dust environments
- Agricultural machinery
- Mining equipment
- Oil and gas hydraulic fracturing (fracking) equipment
- Off-highway vehicles

### Air Cleaner Features

- Unique, flared inlet allows maximum airflow with low restriction
- 21" body diameter
- Two-stage filter system — the first stage removes up to 85% of incoming dust with a tangential air inlet
- Inlet on side, outlet on end (G flow)
- Already tapped to accept filter service indicator (1/8"-27 NPT male)
- Safety filter protects engine inlet during filter change out
- Vacuator™ Valve automatically releases the pre-cleaned dust
- Housing is metal and coated with a black, corrosion- and chemical-resistant polymer paint
- Mounting the unit directly to the engine is not recommended; excessive engine vibration can cause premature air cleaner structural failure



### Accessories

- Mounting bands (order separately).
- If the installed air cleaner will be exposed to rain, snow or debris, an **inlet cap** can prevent moisture ingestion.
- A **service indicator** measures the airflow restriction across the filter, thereby showing how much useful life the filter has left and when to replace the filter (see Accessories section of this catalog).

*Note:* Outlet tapped to accept filter service indicator (1/8"-27 NPT male).



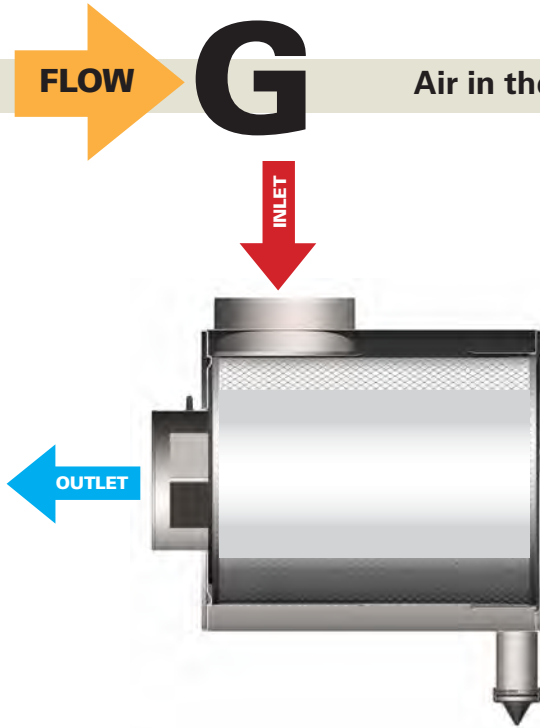

**Air in the Side, Out the End** (standard flow filters)

### When Selecting an Air Cleaner . . .

Determine the airflow requirements of your engine, then find the corresponding cfm airflow in the table below. The restriction numbers (shown in inches of water) indicate the approximate initial restriction of each model air cleaner at that cfm. When calculating total initial restriction of the entire air intake system, include the restriction caused by ducting, elbows, and pre-cleaners. See pages 257-258 for ducting restriction estimates.

The only difference in these two models is the position of the inlet on the air cleaner body. For location and dimensions, see details on next page.

### Initial Airflow Restriction

Airflow CFM @ H <sub>2</sub> O			Air Cleaner Models	Weight	
6"	8"	10"		lbs	kg
1465	1680	1870	G210007 / G210010	88	40

### FTG Air Cleaner Performance Curves (Restriction & Dust Capacity)\*

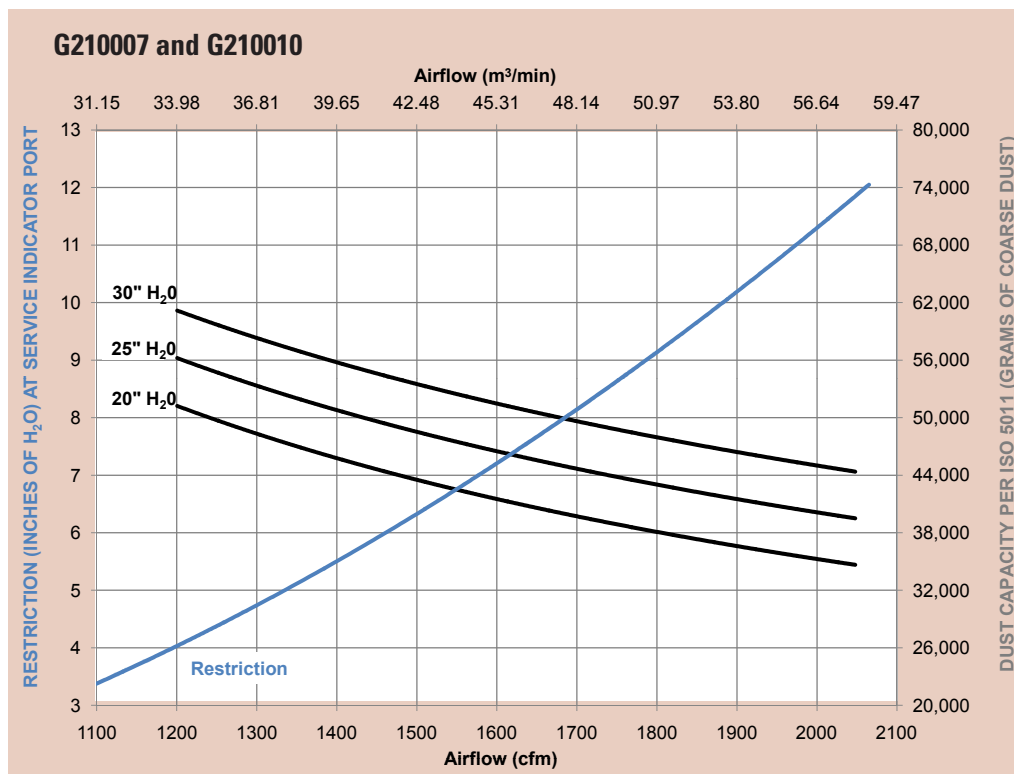

\*Results generated using laboratory testing pursuant to ISO5011. Actual performance during use may vary depending on multiple factors, including specific product configuration, external conditions and application.

**FTG Specification Illustrations**

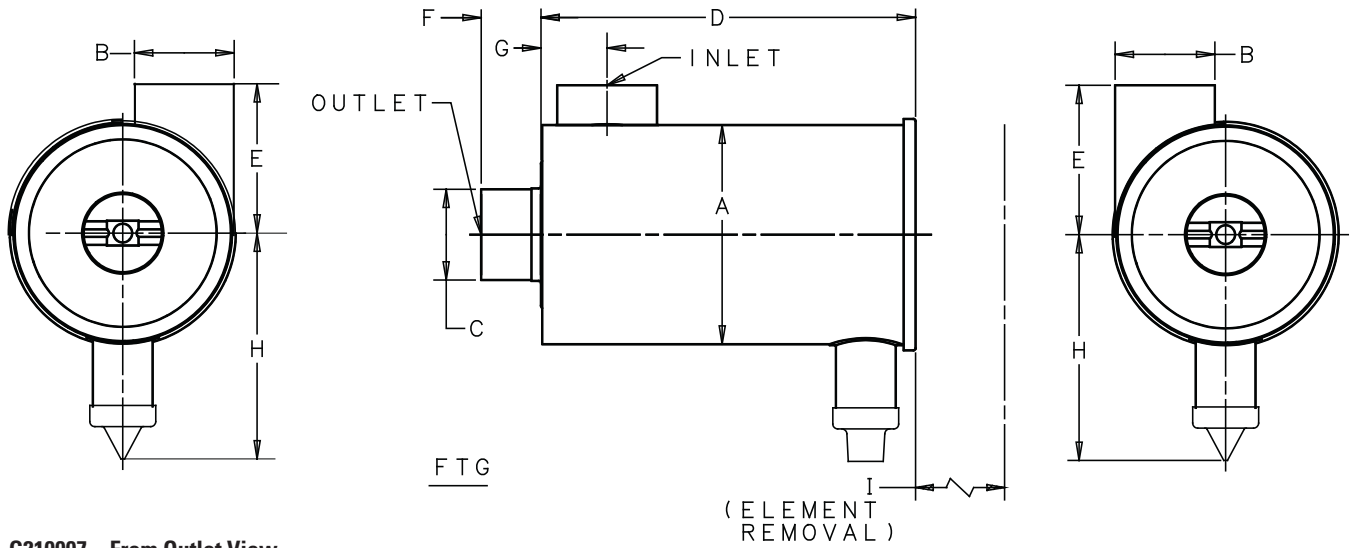

**G210007 – From Outlet View**  
Inlet on RIGHT side of body

**G210010 – From Outlet View**  
Inlet on LEFT side of body

**FTG Specifications**

Air Cleaner Models	Body Diameter (A)		Inlet Diameter (B)		Outlet Diameter (C)		Housing Length (D)		Inlet Location (E)		Center Line to Valve (H)		Service Clearance (I)		Outlet Length (F)	
	in	mm	in	mm	in	mm	in	mm	in	mm	in	mm	in	mm	in	mm
G210007	21.00	546	10.00	254	10.00	254	24.13	613	13.00	330	17.40	442	24.13	613	3.54	90
G210010	21.00	546	10.00	254	10.00	254	24.13	613	13.00	330	17.40	442	24.13	613	3.54	90

**FTG Service Parts**

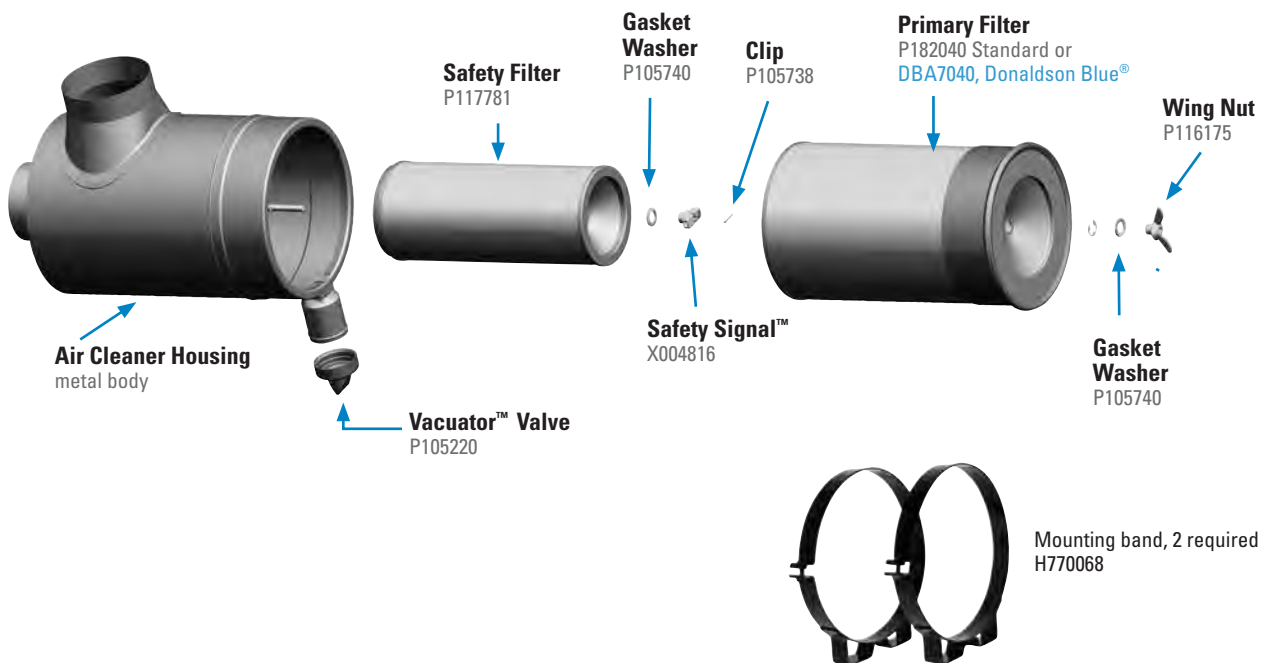





This servicing information is provided as a best practices guide. It is not intended to replace or supersede the service instructions supplied by your engine or vehicle manufacturer.

### 1 Check the Restriction

Check the restriction level of the air cleaner filter service indicator. Replace the filter only when the restriction level has reached the maximum recommended by the engine or equipment manufacturer or on a regular service schedule.



### 2 Clean Out the Vacuator™ Valve

Remove the Vacuator Valve and clean out any dust found in the drop tube. Reinstall Vacuator Valve or replace if found worn or damaged.



Make sure the valve is flexible and not inverted, damaged or plugged. Replace it if damaged or if it looks like any of these images. A damaged or missing Vacuator Valve will disrupt the designed flow of air through the air cleaner.

### 3 Gently Remove the Old Filter

Shut off the engine. Loosen and retain the wing nut bolt, remove bolt and washer. Replace both if damaged or worn.

Using the metal handle, pull the dirty filter gently from the housing. Accidental bumping will shake dirt loose inside the filter housing.



### 4 Visually Check the Safety Filter

Visually check the safety filter without removing it. Replace if damaged or every three primary filter changes. Also verify that the safety filter is properly seated in the housing.

If the safety filter is to be replaced, it should be done immediately or the clean air outlet should be sealed. Use a clean cloth to avoid contaminant being introduced to the engine during service.





## 5 Always Clean the Inside of the Housing

Dirt left in the air cleaner housing is harmful to your engine. Use a clean, damp cloth to wipe the inside of the housing before fitting the new filter.

Block the outlet tube of the air cleaner with a small dampened towel prior to cleaning the seal surface to avoid contaminating the induction system.



## 6 Clean the Gasket Sealing Surfaces

An improper gasket seal is one of the most common causes of engine contamination. Make sure that all hardened dirt ridges are completely removed, both on the bottom and top of the air cleaner housing.

## 7 Inspect Your Old Filter and Check for Uneven Dirt Patterns

Your old filter has valuable clues to dust leakage or gasket sealing problems. A dust pattern on the filter's clean side is a sign that the old filter was not firmly sealed or that a dust leak exists. Identify the cause of any leak and rectify it before installing a new filter.



## 8 Inspect New Filters

Before installing the new filters, visually inspect them for shipping damage and gasket integrity. If a filter is damaged, do not install it. If desired, write the date of the filter change on the outer end of the filter end cap.



## 9 Install the New Filters

First, if you're servicing the safety filter at this change-out, seat it properly into position before installing the primary filter. Insert new filters carefully over the center bolt, hand tighten wing nut bolt for both filters.

Make sure the primary filter gasket seats evenly to create a proper seal. If you don't have a good seal, dirty air can by-pass the filter.



## 10 Ensure an Air-tight Fit on all Connections and Ducts

Check that all clamps and flange joints are tight, as well as the air cleaner mounting bolts. Attend to any leaks immediately to avoid dirt entering your engine directly. Reset the filter service indicator.





## Horizontal Mount, Integral Vacuator™ Valve

### Severe Duty, Two-Stage Filtration for Large Construction & Mining Machines

#### Applications

- Allows up to 1200 cfm airflow throughput per air cleaner
- Horizontal installation
- Designed for large industrial and construction machines — crawler tractors, crane loaders, excavators, and air compressors with large engines operating in severe dust environments

#### Air Cleaner Features

- Unique, flared inlet allows maximum airflow with low restriction
- 21" body diameters
- Two-stage air cleaning deals with very dusty environment:
  - (1) Built-in louver spins air to separate up to 85% of incoming dust before it reaches the filter
  - (2) Primary filter removes up to 99.99% of the remaining dust
- Built-in Vacuator™ Valve collects and releases pre-cleaned dust
- Safety filter on all models protects engine inlet during primary filter change out
- Housing is metal and coated with a corrosion and chemical resistant polymer paint

#### Filter Features

- Replacement filter choices include an extended service, high efficiency filter for restriction maintenance, or a standard life filter for scheduled maintenance

#### Accessories

- See the Accessories section for details on Donaldson air intake add-ons that can enhance the performance of your system
- Each FVG is tapped to accept a filter service indicator
- Order mounting bands, hoods, and other accessories separately



*FVG air cleaners are used in tandem on this underground mining equipment to double the airflow throughput to the engine.*

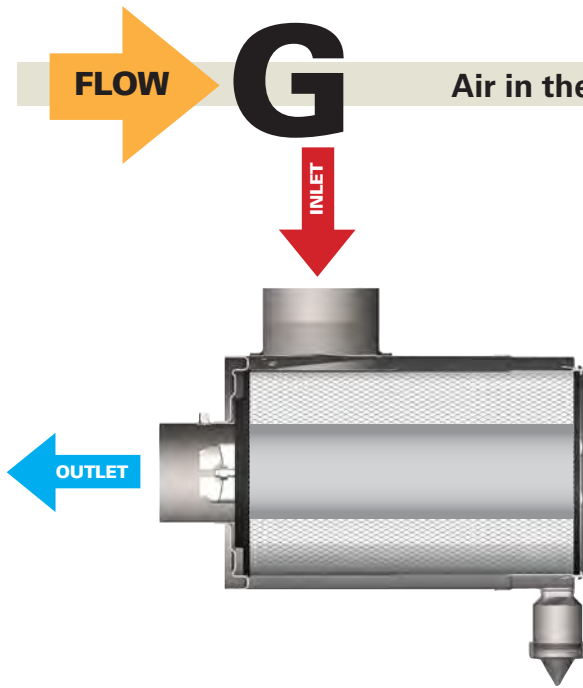

**Air in the Side, Out the End** (standard flow filters)

**When Selecting an Air Cleaner . . .**

Determine the airflow requirements of your engine, then find the corresponding cfm airflow in the table below. The restriction numbers (shown in inches of water) indicate the approximate initial restriction of each model air cleaner at that cfm. If there are two air cleaner models that fit your parameters, choosing the one with the lower restriction will provide longer filter service life. When calculating total initial restriction of the entire air intake system, include the restriction caused by ducting, elbows, and pre-cleaners. See pages 257-258 for ducting restriction estimates.

**Initial Airflow Restriction**

CFM @ "H <sub>2</sub> O			Air Cleaner Model
6"	8"	10"	
690	810	910	G140195
730	880	1000	G160376
930	1070	1200	G160587

Looking for a different air cleaner with newer Donaldson technologies? Check out the FRG Air Cleaners. This line has models that cover this airflow range.

**FVG Air Cleaner Performance Curves (Restriction & Dust Capacity)\***

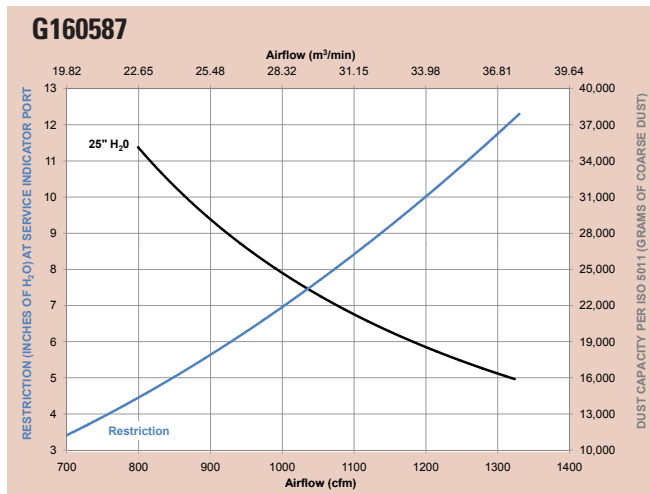
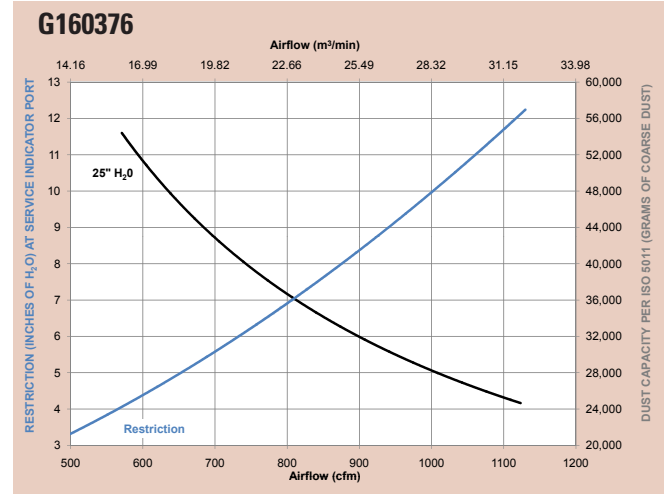
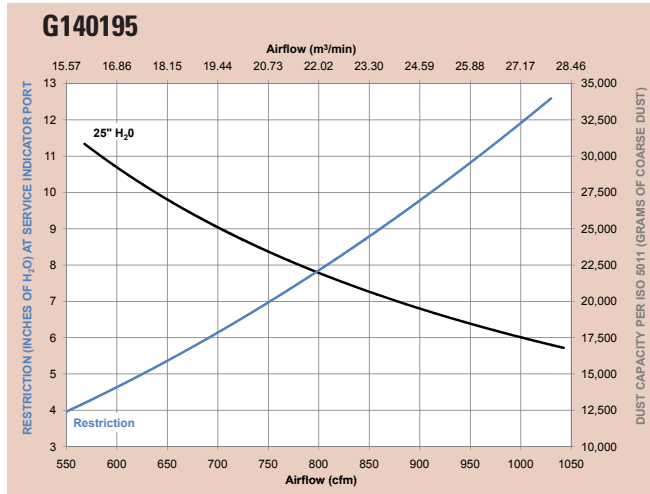

\*Results generated using laboratory testing pursuant to ISO5011. Actual performance during use may vary depending on multiple factors, including specific product configuration, external conditions and application.





## FVG Cycloflow™ Specification Illustration

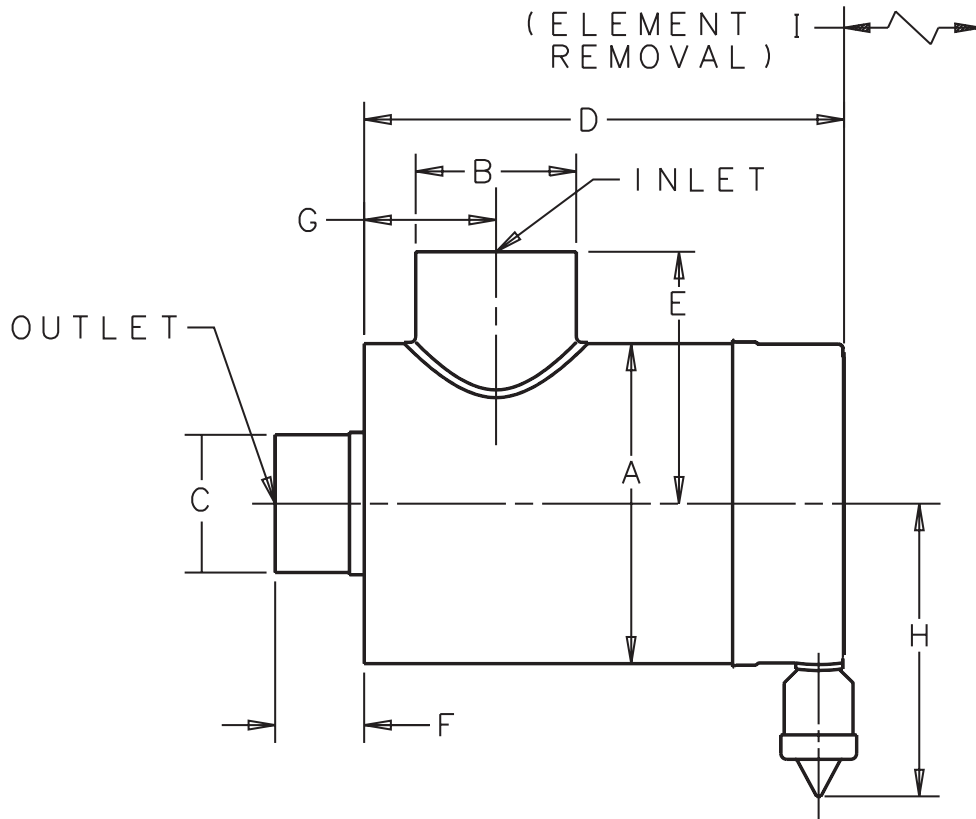

### FVG Specifications

Air Cleaner Models	Body Diameter (A)		Inlet Diameter (B)		Outlet Diameter (C)		Length (D)		Inlet Length (F)		Inlet Diameter (G)		Inlet Length (H)		Service Clearance (I)		Weight			
	in	mm	in	mm	in	mm	in	mm	in	mm	in	mm	in	mm	in	mm	lbs	kg		
G140195	13.95	354	7.00	178	6.00	152	20.87	530	10.98	279	3.88	99	5.75	146	12.71	323	20.72	526	48	22
G160376	16.00	406	7.00	178	7.00	178	20.87	530	13.00	330	3.88	99	5.28	134	13.80	351	20.72	526	62	28
G160587	16.00	406	7.00	178	7.00	178	24.87	632	13.00	330	3.88	99	5.75	146	13.80	351	24.50	622	66	30

For FVG air cleaner service servicing information see page 142.

**FVG Exploded View**

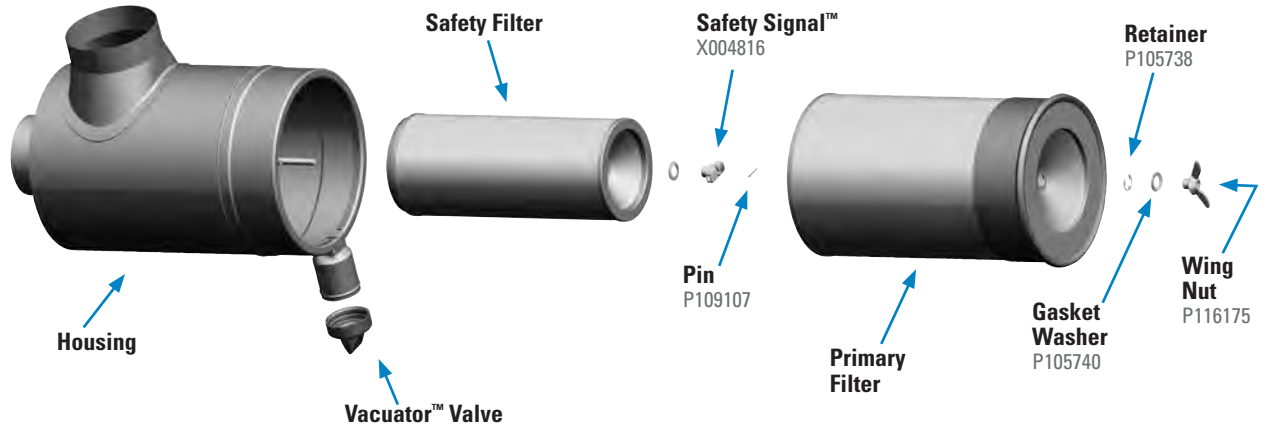

**FVG Service Parts & Accessories**

<b>G140195</b>	<b>FVG</b>	
Elbow, 45° .....	P105547	
Elbow, 90° .....	P105535	
Filter, primary .....	P182043 .....	3
Filter, primary-Donaldson Blue® .....	DBA5043	
Filter, primary - SM .....	P181043	
Filter, safety .....	P124860	
Gasket washer .....	P105740	
Hump hose .....	P105612	
Informer™ indicator 25" H <sub>2</sub> O .....	X002277	
Inlet hood, metal .....	H000339	
Inlet hood, plastic .....	H000607	
Mounting bands, metal .....	H000350 .....	2
Outlet band clamp .....	P148347	
Pin .....	P109107	
Retainer .....	P105738	
SafetySignal indicator .....	X004816	
Vacuator™ Valve .....	P103198	
Wing nut .....	P116175	

<b>G160376</b>	<b>FVG</b>	
Elbow, 45° .....	P105548	
Elbow, 90° .....	P105536	
Filter, primary .....	P124867	
Filter, safety .....	P124866	
Gasket washer .....	P105740	
Hump hose .....	P105613	
Informer™ indicator 25" H <sub>2</sub> O .....	X002277	
Inlet hood, metal .....	H000339	
Inlet hood, plastic .....	H000607	
Mounting bands, metal .....	H000351 .....	2
Outlet band clamp .....	P148348	
Pin .....	P109107	
Retainer .....	P105738	
SafetySignal indicator .....	X004816	
Vacuator™ Valve .....	P103198	
Wing nut .....	P116175	

<b>G160587</b>	<b>FVG</b>	
Elbow, 45° .....	P105548	
Elbow, 90° .....	P105536	
Filter, primary .....	P182049 .....	3
Filter, primary-Donaldson Blue® .....	DBA5049	
Filter, primary - SM .....	P181049	
Filter, safety .....	P116446	
Gasket washer .....	P105740	
Hump hose .....	P105613	
Informer™ indicator 25" H <sub>2</sub> O .....	X002277	
Inlet hood, metal .....	H000339	
Inlet hood, plastic .....	H000607	
Mounting bands, metal .....	H000351 .....	2
Outlet band clamp .....	P148348	
Pin .....	P109107	
Retainer .....	P105738	
Vacuator™ Valve .....	P105220	
Wing nut .....	P116175	

**NOTES:**

- 2 = Two required for proper installation
- 3 = Shipped with air cleaner initially

SM=Scheduled Maintenance  
 Donaldson Blue® = High Efficiency, Extended Service

Even More  
^

## Donaldson Delivers Innovative Filtration Solutions for Engines, Equipment and the People Who Use Them

### Fuel Filtration

Expanded line of fuel filters protect engine components and extend equipment life.

- Donaldson Blue® Fuel filters with Synteq XP™ nanofiber media deliver the cleanest fuel — providing better protection for your injectors.
- Includes a full complement of filters to fit Stanadyne® and Racor® fuel systems, and Cummins® engines.



Stanadyne® is a registered trademark of Stanadyne Corporation. Racor® is a registered trademark of Parker Hannifin Corporation. Cummins® is a registered trademark of Cummins Inc.

### Lube Filtration

Donaldson lube filters keep engine oil clean by capturing contaminants that can cause engine damage.

- With coverage for a full range of popular engines, Donaldson lube filters meet or exceed application requirements.
- Donaldson Blue® lube filters — with Synteq™ media — deliver improved lubricant flow, improved cold start performance and a higher level of engine protection to prolong engine and equipment life.



### Hydraulic and Transmission Filtration

- Offering a broad line of spin-on, cartridge-style and in-tank hydraulic filters — including high, medium and low pressure options — that protect transmissions, machinery and components in hundreds of applications.
- A complete line of hydraulic accessories to accommodate virtually any mobile application.
- T.R.A.P.™ breather technology
- Donaldson Duramax® filters are the highest rated medium pressure filters available.



### Coolant Filtration

- Donaldson coolant filters remove contaminants and maintain cooling system balance — keeping today's hot-running engines cool and reducing downtime.
- Donaldson Blue® coolant filters allow you to extend filter life while maintaining coolant condition.



### Mufflers & Exhaust Accessories

- For more than 60 years, Donaldson has been a leading supplier of exhaust systems, components and accessories for medium- and heavy-duty diesel powered trucks and equipment.



### Heavy-Duty Two-Stage Filtration for Diesel Engines Operating in Severe Dust Conditions

Heavy construction vehicles (haul trucks, crawlers, dozers), above ground and underground mining machines, agricultural equipment (combines, tractors) and other off-highway vehicles and engines that operate daily in intensely dusty environments need powerful, reliable air filtration systems to protect them and keep them running reliably.

Donaldson S Series Air Cleaners provide:

- Durable, reliable protection
- Two cleaning stages to handle very dusty conditions
- Choice of filtration efficiency, Donaldson (standard) and Donaldson Blue® (high efficiency) replacement filters
- Low restriction so the engine receives a high volume of air
- Sturdy, vibration-resistant, long-life construction

### SSG Air Cleaner



SRG Air Cleaner Conversion Kit

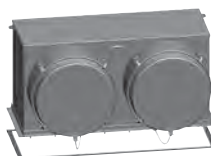

### STG Air Cleaner



### STB Air Cleaner



### Section Index

SSG Donaclone™ .....	150
Service Instructions .....	157
STG Donaclone™ .....	160
Service Instructions .....	166
SRG to SSG Conversion Kit .....	169
SRG Donaclone™ Service Instructions .....	170
STB Strata™ .....	174

### Donaclone® Tubes

The pre-cleaner of our S Series air cleaners uses clusters of Donaclone tubes positioned ahead of the primary filter. The Donaclone tube has no mechanical moving parts, so there's nothing to break down; it works automatically and properly whenever the engine is on.



Air is drawn into the tube and spun. Centrifugal force separates much of the dirt in the airstream. Dirt falls out the bottom of the tube, while the cleaned air is drawn up through the middle of the tube and into the primary filter for further cleaning. Using the pre-cleaner as a first stage of filtration results in more effective engine air filtration and longer service life for the primary filter.

### Attention: Upgrade SRG Models to Newer Filtration Technology!

The SRG air cleaner models will be phased out over time and replaced with our new SSG air cleaners.

Upgrade your housing to an SSG style with RadialSeal™ filters for faster filter changeout.

SRG Housing Item No.	SRG to SSG Kit Kit No.	SSG Housing Item No.
G200008 .....	X009702 .....	G200087
G200013 .....	X009701 .....	G200086
G290000 .....	X009230 .....	G290057
G290023 .....	X009230 .....	G290052
G290012 .....	X009231 .....	G290053





## Designed for the Worst Dust Conditions

### New Choice for Construction and Off-Highway Applications

The SSG Air Cleaner offers design improvements over our older SRG air cleaner style.

#### Design Improvements

The SSG Air Cleaner has filters that use RadialSeal™ sealing technology, compared to axial seal style filters.

This single design improvement eliminates the need to replace filter and cover gaskets, which means less service time and fewer parts to inventory.



Additional design improvements: the air cleaner service cover now has quick-release cover latches and a chain that connects it to the housing.



The large, massive mining vehicle in the picture above is an ideal match for the Donaldson SSG Air Cleaner.

## Ultra-Web® HD

The Donaldson Blue® replacement filters for the SSG Air Cleaner (and the SRG, STG, and STB Air Cleaners) now come standard with Ultra-Web® HD media that provides even greater efficiency than previous generation nanofibers.



**Ultra-Web® HD**  
Up to 99.999%  
Filtration Efficiency  
0.01 gram dust



**Ultra-Web®**  
Up to 99.99%  
Filtration Efficiency  
0.1 gram dust



**Cellulose**  
Up to 99.9%  
Filtration Efficiency  
1 gram dust

This illustration represents the relative amount of dust particles that pass through air filters to the engine.



Note: Extra lead time may be required for processing and shipping.

## Versatile SSG Provides Airflow to 4800 cfm With Improved Design Features Compared to our Older SRG Model

### Applications

- Allows 1700 to 2400 cfm airflow throughput for the SSG 20 model and 2580 to 4800 cfm airflow throughput for the SSG 29 models
- Horizontal installation
- Off-road, heavy or extreme dust conditions
- Ideal for scrapers, earth movers, graders and haul trucks

### Air Cleaner Features

- Single and dual outlet models — two high-flow models available
- Inlet has perforated holes on three sides; rain shrouds available if required
- Filters have urethane end caps with RadialSeal™ sealing technology
- Built-in pre-cleaning tubes separate up to 97% of the in-coming dust
- Latch-style cover with attached safety chain for faster and simpler filter service
- Constructed of heavy-gauge steel with a primed, ready-to-paint finish
- Same overall package size as older Donaldson SRG axial seal style housings
- Dust Dumpa tube accessory available — simplifies routine air cleaner inspections

### Filter Features

- Replacement primary filter choices: Standard life filters (for scheduled maintenance) and Donaldson Blue® Ultra-Web® HD ultra-high efficiency, extended service filters for restriction maintenance practices. Air cleaners ship with the standard filters.
- Grab handles on the primary filter to help remove the loaded filter during service
- Safety filter on all models



Dust Dumpa kits installed on a Donaldson SSG29 with rain shields. Notice the piles of dust gathered on the platform during vehicle operation.

### Powerful Two-Stage Filtration

The first stage of this powerful air cleaner consists of hundreds of our exclusive, patented Donaclone™ pre-cleaner tubes. Each tube spins the incoming air to create a centrifugal force that separates up to 97% of the dust and dirt in the airstream. Donaclone™ tubes have no moving parts — so there is nothing to break down or maintain. They function properly whenever the engine is running.



The pre-cleaned dust is automatically ejected from the dust cup with a Vacuator™ Valve, which is located below the lower housing body.

The second stage of filtration is the primary filter. A safety filter, which fits inside the primary filter, is standard on all models for protection during primary filter change out.



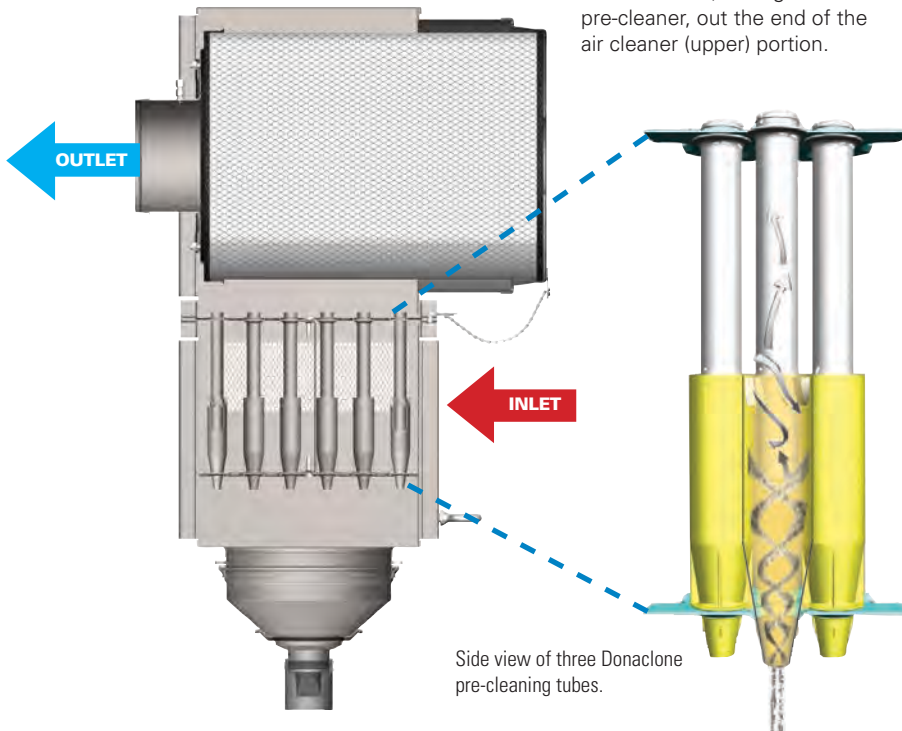

**Initial Airflow Restriction**

CFM @ 6"	"H <sub>2</sub> O 8"	Air Cleaner Model
<b>SINGLE OUTLET MODELS</b>		
1700	1980	G200087
1780	2060	G200086
2100	2400	G200088*
<b>DUAL OUTLET MODELS</b>		
2580	3000	G290057
3340	3800	G290052
3600	4080	G290053
4200	4800	G290055*

\*Sized to accommodate higher airflow.

**When Selecting an Air Cleaner . . .**

Determine the airflow requirements of your engine, then find the corresponding cfm airflow in the table above. The restriction numbers (shown in inches of water) indicate the approximate initial restriction of each model air cleaner at that cfm. If there are two air cleaner models that fit your parameters, choosing the one with the lower restriction will provide longer filter service life. When calculating total initial restriction of the entire air intake system, include the restriction caused by ducting, elbows, and pre-cleaners. See pages 257-258 for ducting restriction estimates.

**SSG Air Cleaner Performance Curves\*\***

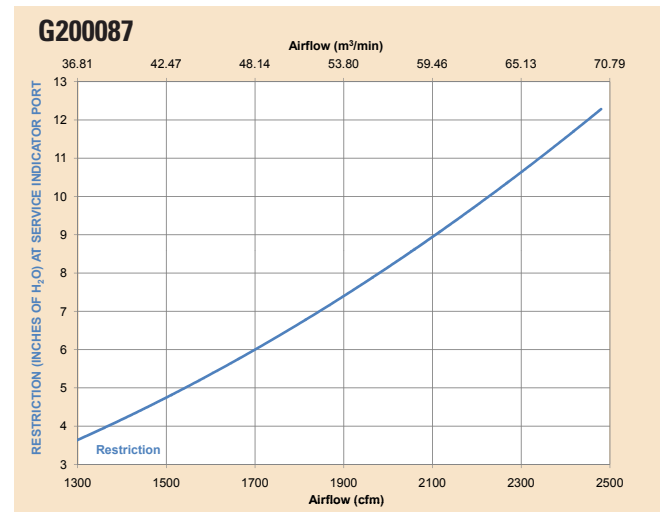
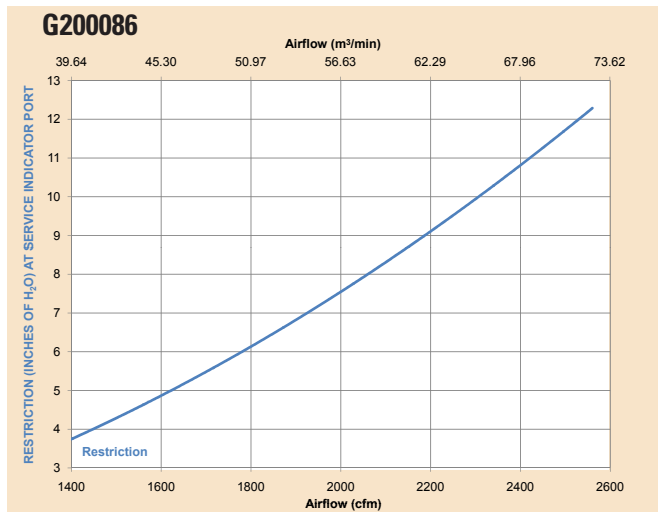

\*\*Results generated using laboratory testing pursuant to ISO5011. Actual performance during use may vary depending on multiple factors, including specific product configuration, external conditions and application.

continued — S<sup>SS</sup>G Air Cleaner Performance Curves

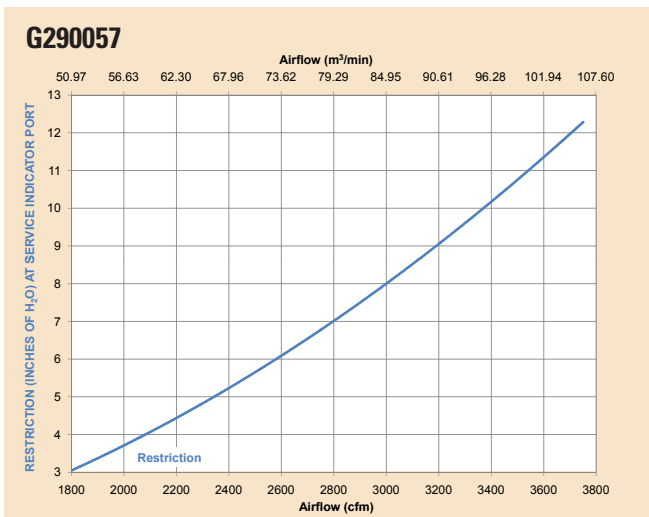
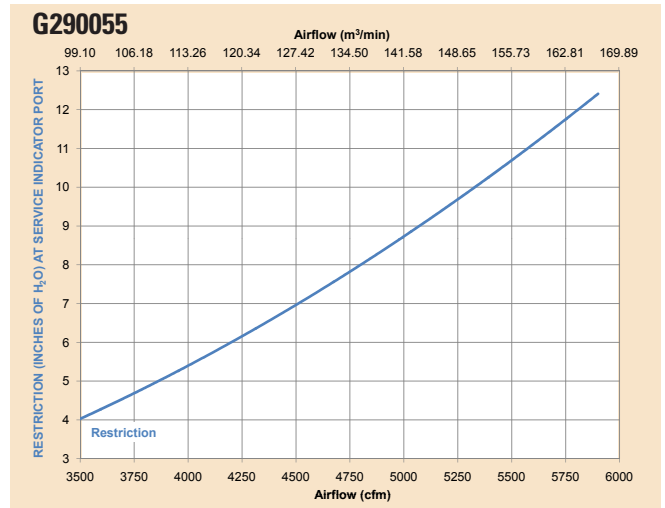
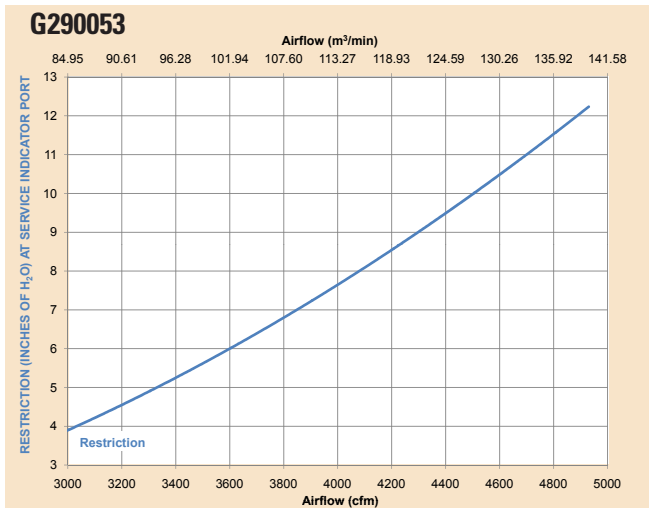
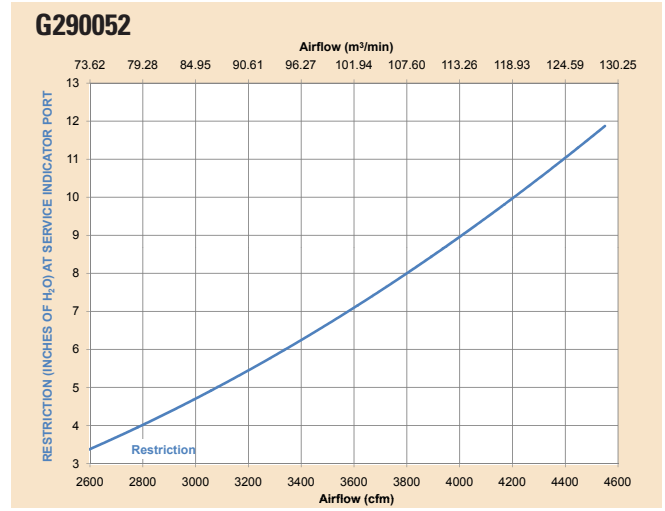
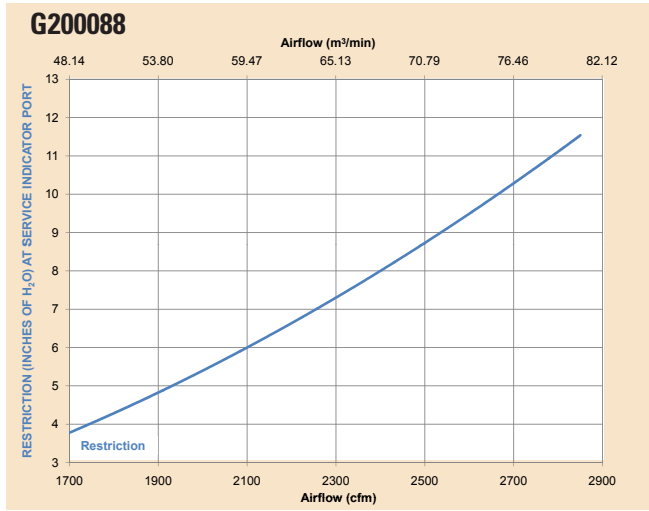





## SSG Specification Illustrations

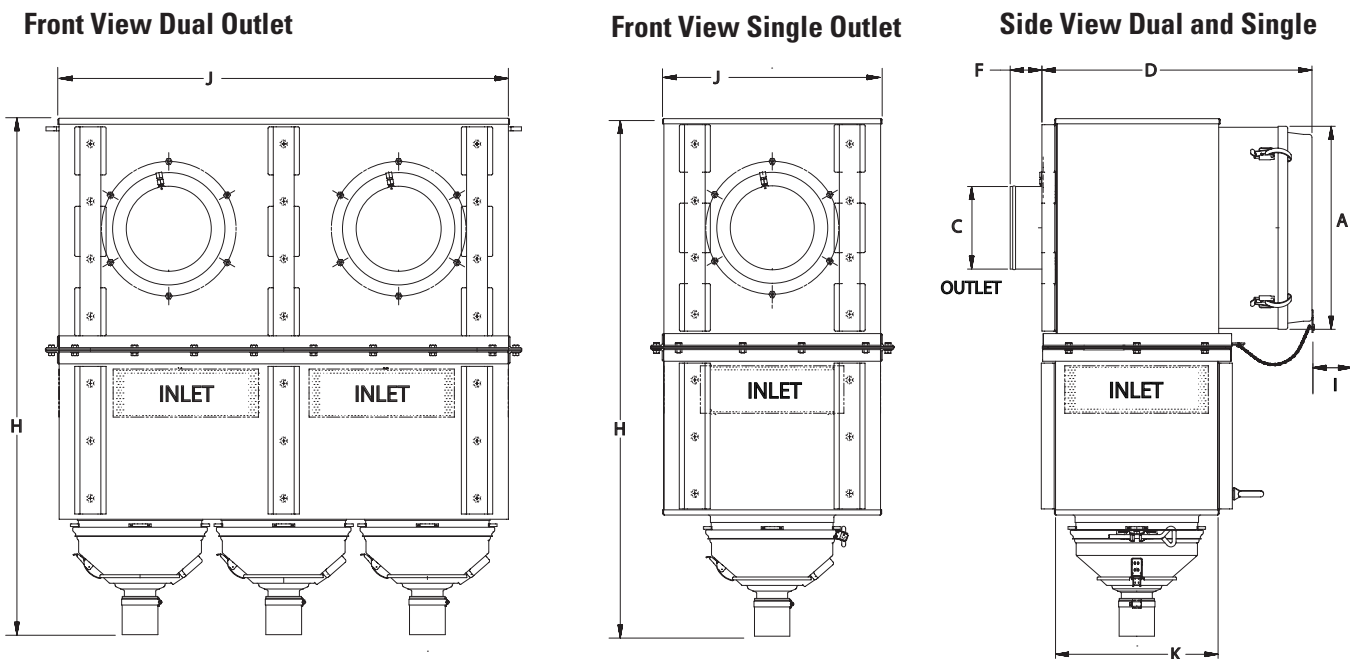

### SSG Specifications

Air Cleaner Models	Body Diameter (A)		Outlet Diameter (C)		Length (D)		Outlet Length (F)		Height (H)		Service Clearance (I)		Width (J)		Depth (K)		Weight	
	in	mm	in	mm	in	mm	in	mm	in	mm	in	mm	in	mm	in	mm	lbs	kg
<b>SINGLE OUTLET MODELS</b>																		
G200087	19.67	500	8.0	203	26.2	665	3	76	50.15	1274	22.0	559	21.00	533	15.75	400	200	91
G200086	19.67	500	10.0	254	26.2	665	3	76	50.15	1274	22.0	559	21.00	533	15.75	400	200	91
G200088	19.67	500	10.0	254	31.4	798	3	76	50.15	1274	27.0	686	21.00	533	23.50	597	240	109
<b>DUAL OUTLET MODELS</b>																		
G290057	19.67	500	8.0	203	26.2	665	3	76	49.42	1255	22.0	559	43.00	1092	15.75	400	340	154
G290052	19.67	500	8.0	203	26.2	665	3	76	49.42	1255	22.0	559	43.00	1092	15.75	400	340	154
G290053	19.67	500	10.0	254	26.2	665	3	76	49.42	1255	22.0	559	43.00	1092	15.75	400	340	154
G290055	19.67	500	10.0	254	31.4	798	3	76	49.42	1255	27.0	686	43.00	1092	23.50	597	420	190

### Accessories Recommendations

Air Cleaner Model	Outlet Band Clamp	Hump-hose Connector	Elbows		Restriction Indicator
			45°	90°	
G200088	P148350	P111414	P114313	P114314	X002277
G290055	P148350	P111414	P114313	P114314	X002277
G290057	P629991	P112608	P112606	P112605	X002277

**Service Parts Listing by Model Number**

**Single Outlet Model — SSG 20**

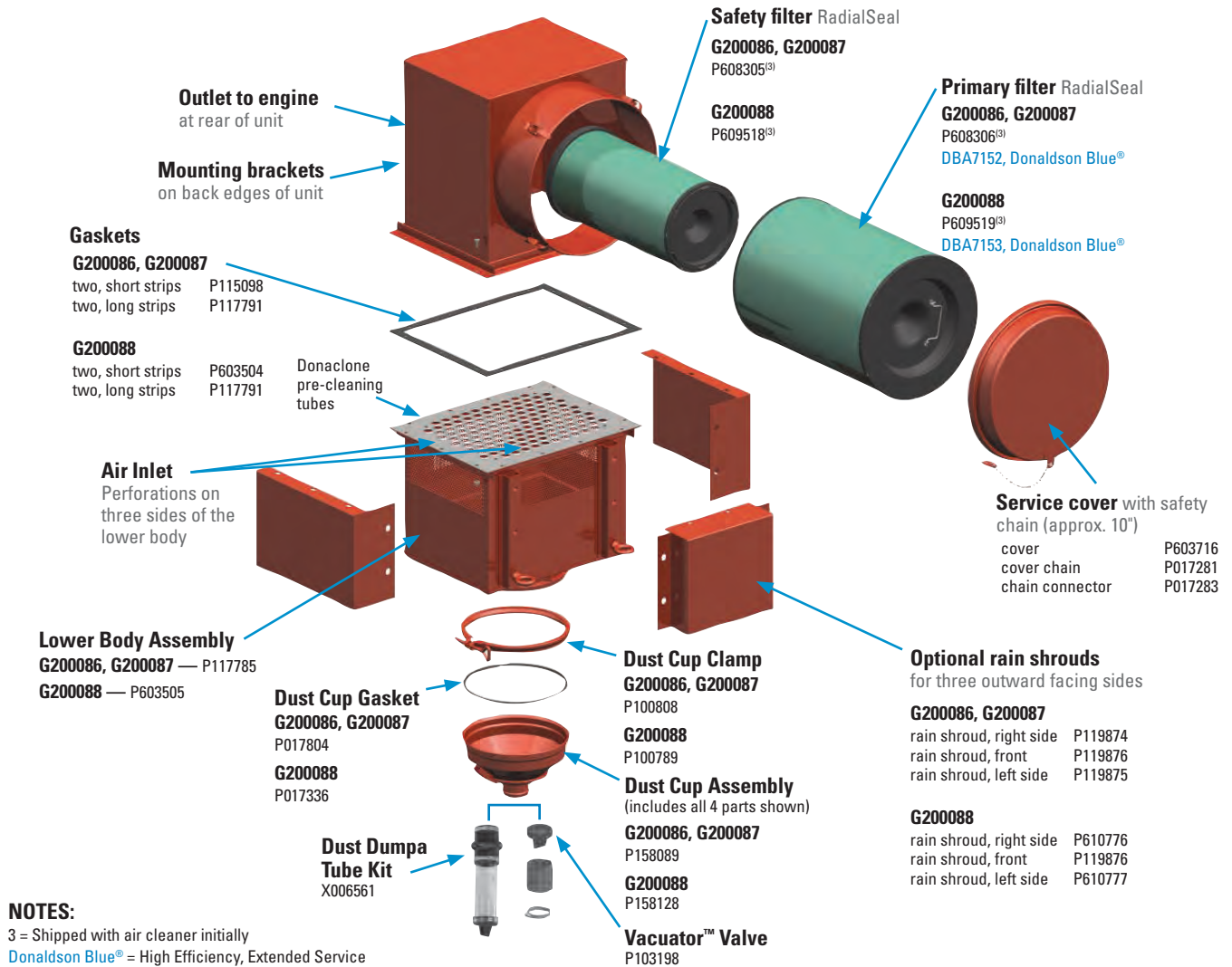

**Mounting (back) side view of an SSG 20 model**

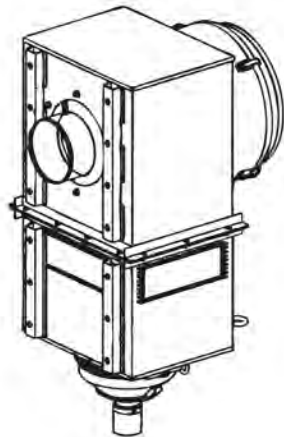

**SSG Housing Primary Filter Choices**

For ultra-high efficiency filtration, upgrade to Donaldson Blue® Air Filters with Ultra-Web® HD Filtration Technology. SSG Air Cleaners and retrofit kits ship with standard life filters.

Air Cleaner	Standard Life	Ultra-High Efficiency
G200086	P608306	DBA7152
G200087	P608306	DBA7152
G200088	P609519	DBA7153

**Ultra-Web® HD**

Donaldson Blue® air filters for SSG air cleaners have Ultra-Web® HD media that provides higher efficiency compared to previous generation nanofibers.





Service Parts Listing by Model Number

Dual Outlet Model — SSG 29

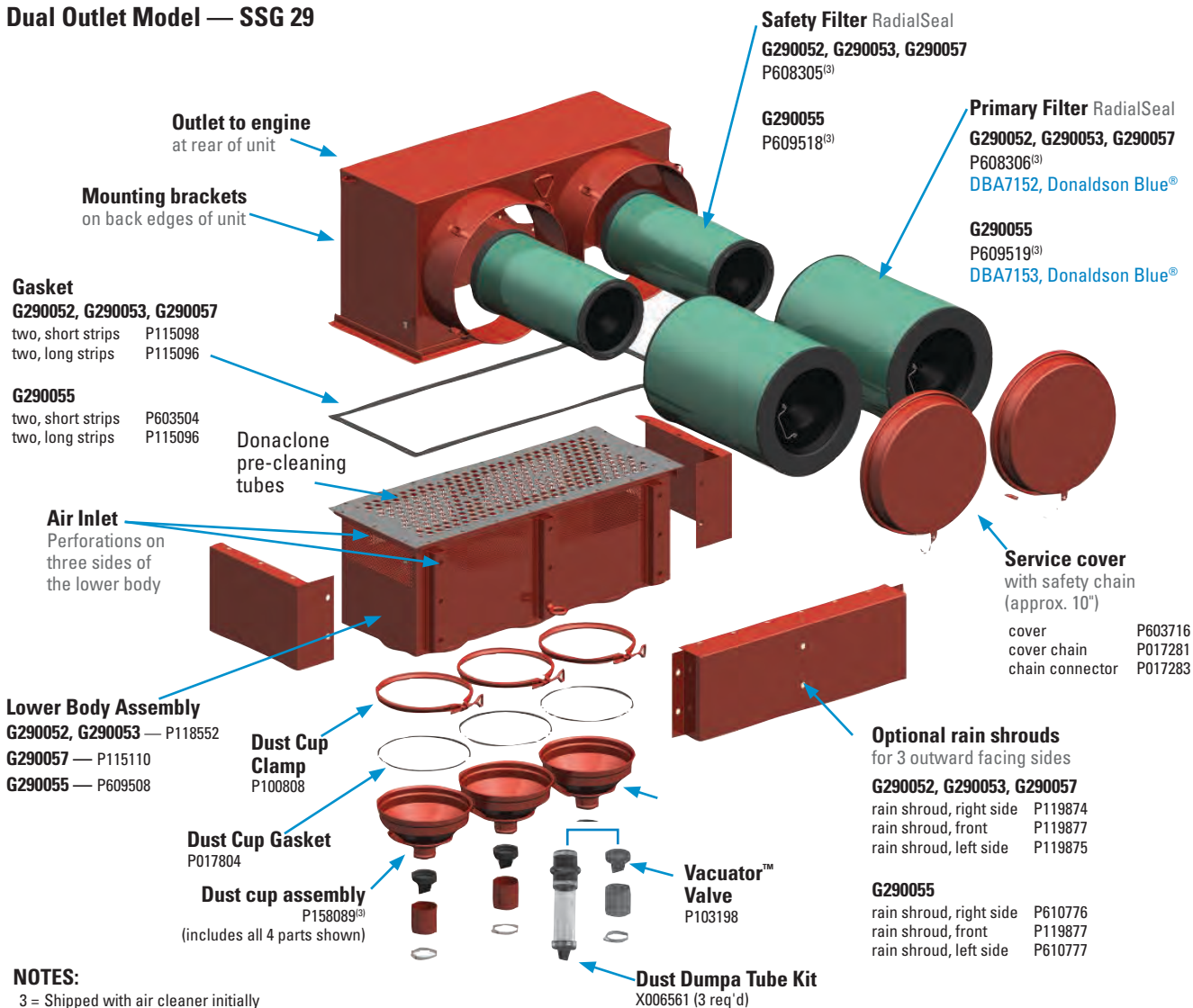

NOTES:

3 = Shipped with air cleaner initially  
Donaldson Blue® = High Efficiency, Extended Service

Mounting (back) side view of an SSG 29 model

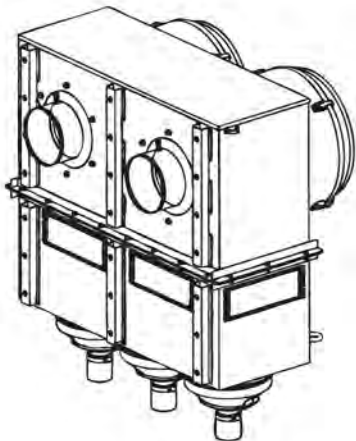

SSG Housing Primary Filter Choices

For ultra-high efficiency filtration, upgrade to Donaldson Blue® Air Filters with Ultra-Web® HD Filtration Technology. SSG Air Cleaners and retrofit kits ship with standard life filters.

Air Cleaner	Standard Life	High Efficiency
G290052	P608306	DBA7152
G290053	P608306	DBA7152
G290055	P609519	DBA7153
G230057	P608306	DBA7152

Ultra-Web® HD

Donaldson Blue® air filters for SSG air cleaners have Ultra-Web® HD media that provides higher efficiency compared to previous generation nanofibers.



This servicing information is provided as a best practices guide. It is not intended to replace or supersede the service instructions supplied by your engine or vehicle manufacturer.

**SERVICE TRAINING VIDEOS**



<http://www.youtube.com/user/donaldsonengine>

Donaldson Service Training Videos are on YouTube. Scan the QR code or go to <http://www.youtube.com/user/donaldsonengine> to watch videos on how to service Donaldson Air Cleaners, like the SSG.

**1 Check the Restriction**

Replace the filter only when the restriction level has reached the maximum recommended by the engine or equipment manufacturer.



**2 Empty the Dust Cup & Check the Vacuator™ Valve**

Shut off the engine. The dust cup should be emptied when it is 2/3 full. Frequency of dust cup service varies with dust severity. On dust cups with a Vacuator™ Valve, dust cup service is minimal.

Just check the Vacuator™ Valve to see that it is not inverted, damaged or plugged. If it looks damaged or is missing, replace it immediately. When reinstalling the dust cup, be sure it seals properly 360° around the air cleaner body.

The optional Donaldson Dust Dumpa tube extension is available for the SSG.



If your SSG Air Cleaner has a dust cup with a Vacuator Valve, replace it immediately if it is inverted or looks like any of the images below.

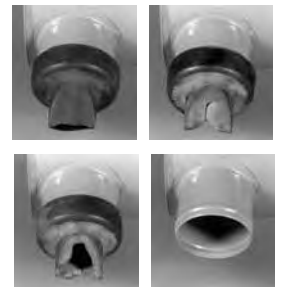

**3 Inspect the Donaclone™ Pre-Cleaning Tubes**

Visually check the Donaclone tubes. Generally, the tubes are self-cleaning and need no service, but under unusual circumstances, plugging can occur. In those circumstances, cleaning with a stiff brush may be required.

Never clean Donaclone tubes with compressed air unless both the primary and safety filters are properly fitted in place. Do not steam-clean Donaclone tubes.

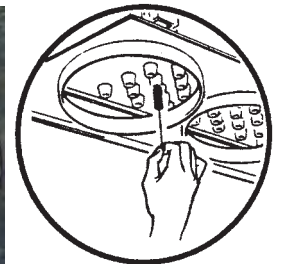

Continued on next page





### 4 Remove the Primary Filter and Visually Inspect the Safety Filter

When the restriction indicates that filter service is required, unfasten or unlatch the filter service cover. Because the filter fits tightly over the outlet tube there will be some initial resistance, similar to breaking the seal on a jar. Grasp the filter service handle and pull the filter out. Gently move the filter from side to side to break the seal, but avoid knocking the filter against the housing during removal.

Visually check safety filter for damage and replace if damaged, but do not remove it unless a change-out is necessary. You should replace the safety filter every three primary filter changes. Also verify that the safety filter is properly seated in the housing. If the safety filter is removed and the new filter is not to be installed immediately, be sure to cover the seal tube with a cloth or the housing cover.

Wipe the interior of the air cleaner with a clean damp cloth.



*Note: If you perform filter maintenance service on a schedule vs. using service indicators, you may want to write the service date on the filter end cap.*

*The safety filter should be replaced every three primary filter changes.*

### 5 Inspect and Install the New Filter(s)

Inspect the new filter carefully, paying attention to the inside of the open end, which is the sealing area. NEVER install a damaged filter. A new Donaldson RadialSeal™ filter may have a dry lubricant on the seal to aid installation.

If you are servicing the safety filter, make sure it is seated into position before installing the primary filter.

Insert the new filter carefully by hand, making certain it is completely seated into the air cleaner housing before securing the cover in place.

The critical sealing area will compress slightly, adjust itself and distribute the sealing pressure evenly. To complete a tight seal, apply pressure by hand at the outer rim of the filter, not at the center. (Avoid pushing on the center of the end cap.) No cover pressure is required to hold the seal.



*Note: NEVER use the service cover to push the filter into place! Using the cover to push the filter in could cause damage to the housing or cover fasteners and will void the warranty.*

If the service cover contacts the filter before it is fully in place, remove the cover and push the filter (by hand) further into the air cleaner and try again. The cover should go on with no extra force.

Once the filter is in place, secure the service cover.



## **6 Inspect Air Cleaner System**

Finally, inspect and tighten all air cleaner system hoses, tubing and connections. If there are holes or damage, replace immediately. Reset filter service indicators if they don't automatically reset.





## STG Donaclone: Field Proven & Reliable Heavy-Duty Workhorse for Construction & Off-Highway Applications

Donaldson's STG Donaclone™ air cleaner has been applied to a wide variety of heavy-duty equipment around the world. Its broad application is a testament to its reliability and durability.

### Powerful Two-Stage Filtration

The first stage of this powerful air cleaner consists of a cluster of our Donaldson Donaclone™ tubes. They spin the incoming air to create a centrifugal force that separates up to 97% of the dust and dirt in the airstream. Donaclone™ tubes have no moving parts — so there is nothing to break down or maintain. They function properly whenever the engine is running.

Pre-cleaned dust falls into the dust cups and expels through Vacuator™ Valves at the bottom of the air cleaner.

The second stage of filtration is the primary filter, a cylindrical-shaped unit of specially-developed pleated filter media, designed to trap and stop dust particles, both large and small. The result is air to your engine that is up to 99.9% contaminant free!

A safety filter, which fits inside the primary filter, is standard on all models for protection during primary filter changeout. Physical orientation does not affect the proper functioning of either cleaning stage. The STG can be mounted horizontally or vertically. If mounting horizontally, the Vacuator™ Valve option on the dust cup is required.



*This STG Donaclone, mounted on a large mining machine, is protecting the engine from harmful dirt in this severe dust environment.*

**Mounting:** Sturdy mounting brackets are attached to the top section of the STG. For secure mounting, Donaldson recommends an additional mounting band for the lower body.

STG air cleaners feature a corrosion-resistant, chemical-resistant coating that provides a long-lasting, hard protective finish.

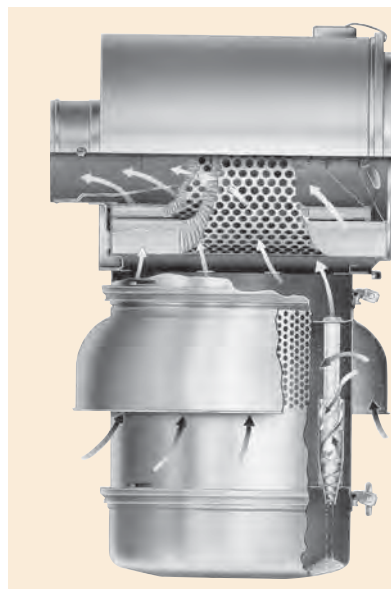

### How the Two-Stage STG Donaclone Works

Air is drawn in through the perforations in the lower part of the unit and forced down through a bank of Donaclone tubes. The Donaclone tubes spin the air so that centrifugal force causes the heavier dust particles to separate from the airstream.

While these particles fall into the cup at the bottom, the partially cleaned air is directed upward, into the primary filter in the upper portion of the unit for the second stage of filtration.



## Versatile STG Provides Airflow to 1760 cfm Choose Peripheral or Tubular Inlet, Horizontal or Vertical Mount

### Applications

- Allows 390 to 1760 cfm airflow throughput per air cleaner
- Horizontal or vertical installation
- Off-road, high dust conditions
- Ideal for scrapers, earth movers, graders

### Air Cleaner Features

- Very reliable. Only one critical filter seal.
- Airflow throughput can be doubled by using two air cleaners
- Two body styles (peripheral inlet, shown on right, and tubular inlet) to accommodate location and ducting
- Optional inlet shroud available for peripheral style
- When the air cleaner is mounted directly on the engine and there is clearance around it for airflow, choose the peripheral inlet style (shown on right)
- When the air cleaner is mounted above the cab or somewhere far from the engine to get above the dust cloud, choose the tubular inlet style, which will accept ducting into the inlet
- Built-in Donaclone pre-cleaning tubes separate up to 97% of incoming dust to the dust cup before it reaches the filter, resulting in more thorough cleaning and fewer filter changes.
- Choose the dust cup best suited to your maintenance practices. For choices see Accessories section.
- All models include a fitting for a filter service indicator

### Filter Features

- Replacement primary filter choices: Standard life filters (for scheduled maintenance) and Donaldson Blue® Ultra-Web® HD ultra-high efficiency, extended service filters for servicing by restriction
- Uses standard airflow filters
- Safety filter on all models

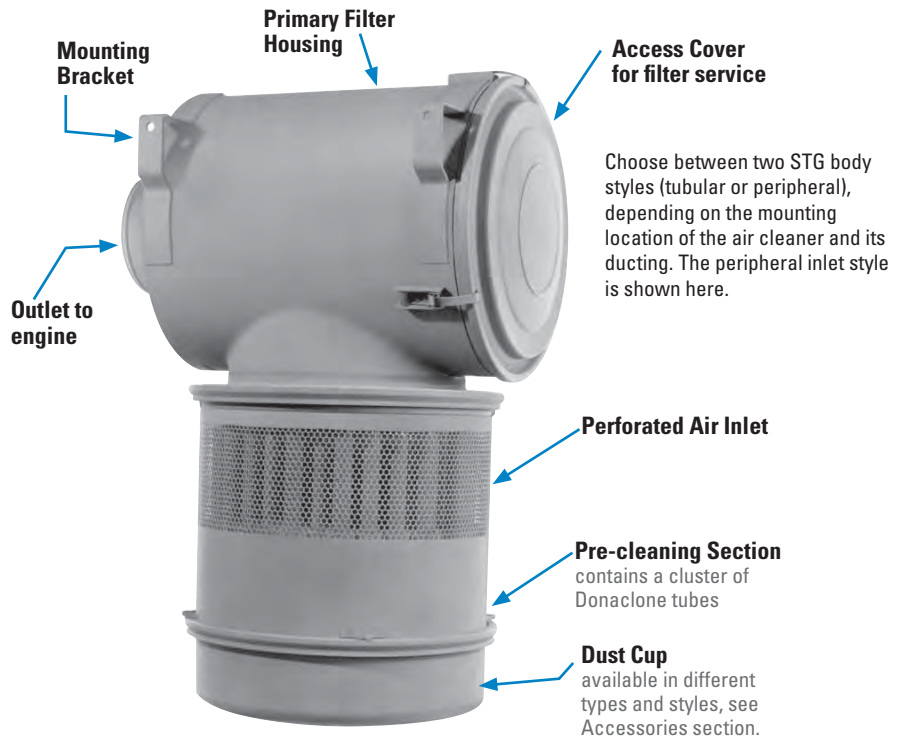

Choose between two STG body styles (tubular or peripheral), depending on the mounting location of the air cleaner and its ducting. The peripheral inlet style is shown here.

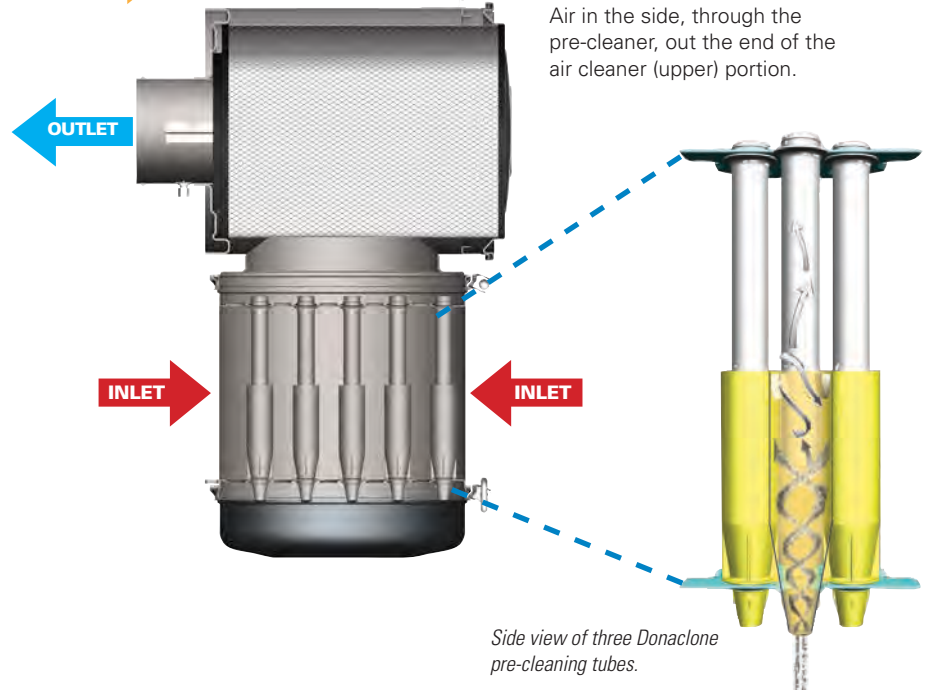
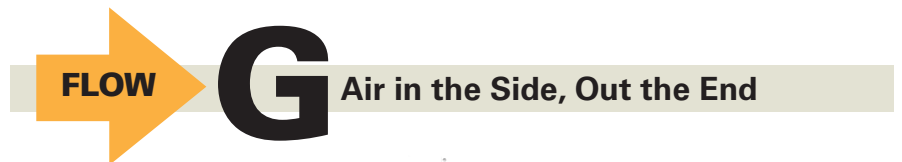

Side view of three Donaclone pre-cleaning tubes.





## STG Air Cleaner Performance Curves (Restriction & Dust Capacity)\*

Determine the airflow requirements of your engine, then find the corresponding cfm airflow in the table on the next page. The restriction numbers (shown in inches of water) indicate the approximate initial restriction of each model air cleaner at that cfm. If there are two air cleaner models that fit your parameters, choosing the one with the lower restriction will provide longer filter service life. When calculating total initial restriction of the entire air intake system, include the restriction caused by ducting, elbows, and pre-cleaners. See pages 257-258 for ducting restriction estimates.

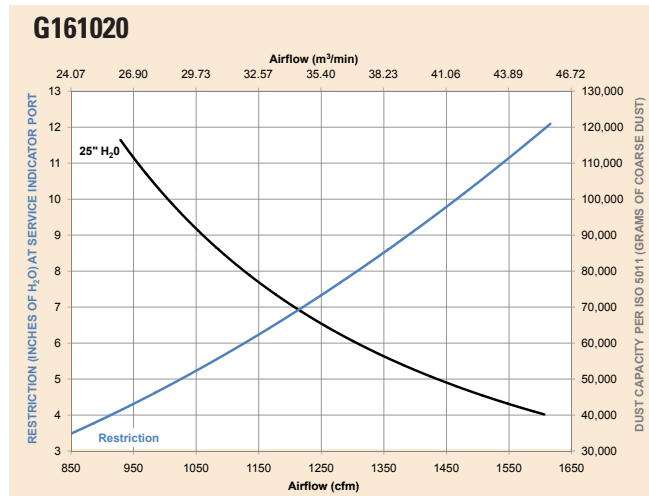
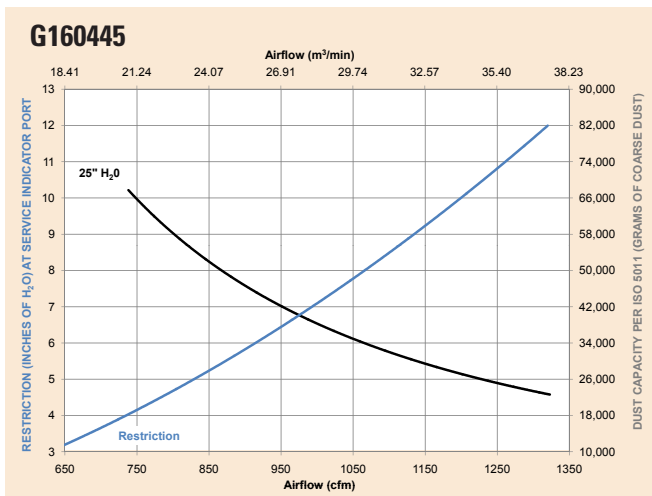
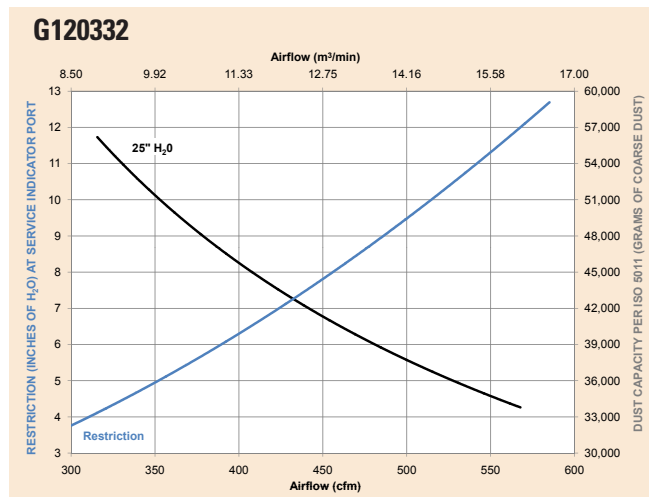
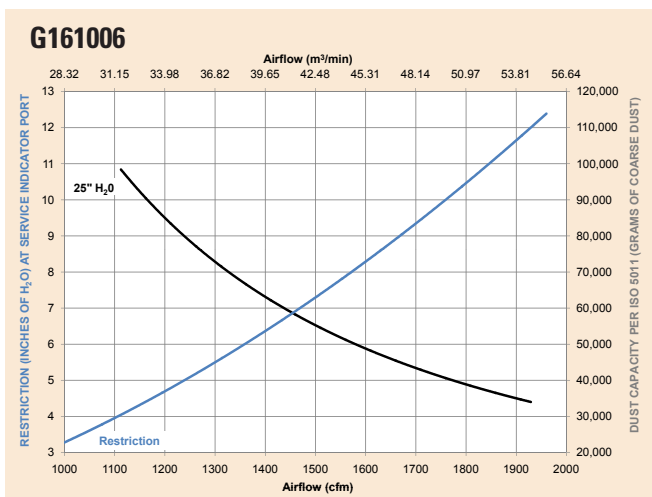
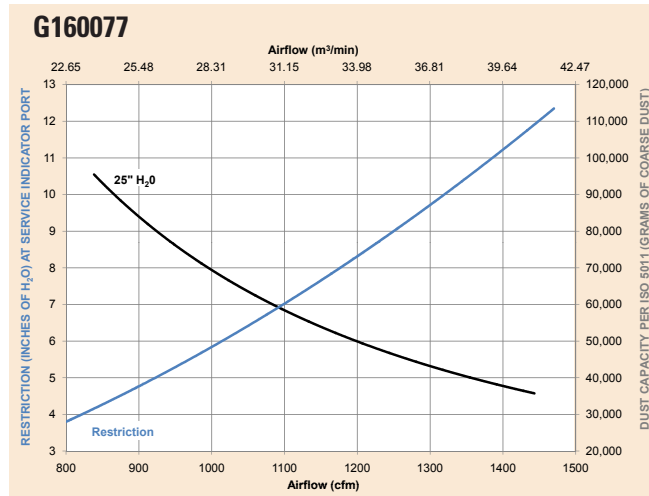

\*Results generated using laboratory testing pursuant to ISO5011. Actual performance during use may vary depending on multiple factors, including specific product configuration, external conditions and application.

**Initial Airflow Restriction**

Air Cleaner Model	CFM @ "H <sub>2</sub> O		
	6"	8"	10"
<b>STG WITH PERIPHERAL INLET</b>			
G140076	710	840	950
G160077	1015	1175	1320
G161006	1360	1570	1760

Air Cleaner Model	CFM @ "H <sub>2</sub> O		
	6"	8"	10"
<b>STG WITH TUBULAR INLET</b>			
G120332	390	455	515
G160445	915	1065	1200
G161020	1127	1308	1466

**STG Specification Illustrations**

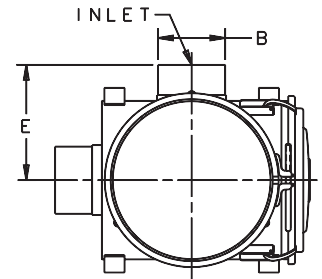
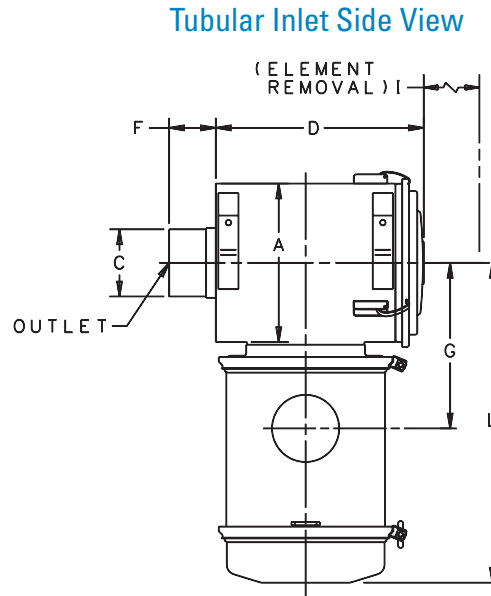
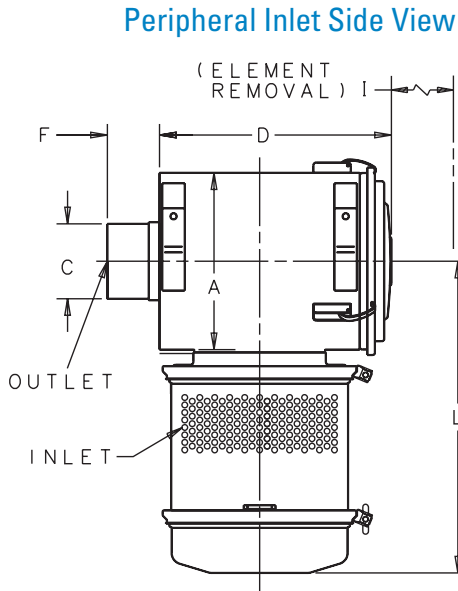

**STG Donaclone™ Specifications**

Air Cleaner Models	Body Diameter (A)		Inlet Diameter (B)		Outlet Diameter (C)		Length (D)		Inlet Length (F)		Inlet Length (G)		Service Clearance (I)		Length (L)		Weight			
	in	mm	in	mm	in	mm	in	mm	in	mm	in	mm	in	mm	in	mm	lbs	kg		
<b>STG WITH PERIPHERAL INLET</b>																				
G140076	14.00	356	n/a		6.00	152	17.38	441	n/a	3.88	99	15.47	393	15.25	387	24.16	614	75	34	
G160077	16.00	406	n/a		7.00	178	19.69	500	n/a	3.88	99	17.29	439	17.00	432	26.16	664	91	41	
G161006	16.00	406	n/a		8.00	203	26.06	662	n/a	3.50	89	17.30	439	23.38	594	26.93	684	115	52	
<b>STG WITH TUBULAR INLET</b>																				
G120332	11.81	300	5.00	127	5.00	127	15.43	392	7.88	200	3.94	100	11.54	293	13.19	335	22.06	560	53	24
G160445	16.00	406	7.00	178	7.00	178	19.59	498	11.00	279	3.87	98	14.81	376	17.25	438	26.31	668	93	42
G161020 <sup>1</sup>	16.00	406	6.00	152	8.00	203	26.06	662	10.02	255	3.50	89	14.06	357	23.38	594	26.31	668	120	55

1 - G161020 has two inlets, each 6" (152mm) in diameter

NOTE: All STG models are tapped to accept a filter service indicator

**Accessory Recommendations**

Air Cleaner Model	Mounting Band Metal	Outlet Band Clamp	Hump-hose Connector	Elbows			Restriction Indicator	Inlet Hood	
				45°	90°	90° Reducing		Plastic	Metal
G120332	H000349	P148345	P105610	P109021	P107844	P143895	X002277	H000469	H000165
G140076	H000350	P148347	P105612	P105547	P105535	P143895	X002277		
G160077	H000351	P148348	P105613	P105548	P105536		X002277		
G161006	H000351	P629991	P112608	P112606	P112605		X002277		
G161020	H000351	P148347	P105612	P105547	P105535		X002277		



## STG Peripheral Service Parts

### G140076 STG-PERIPHERAL

Body, lower .....	P102256
Clamp, cup.....	P100866
Cover latch assembly .....	P017617
Dust cup.....	P100860 .....3
Elbow, 45° .....	P105547
Elbow, 90° .....	P105535
Filter, primary .....	P182041 .....3
Filter, primary-Donaldson Blue® ... DBA7041	
Filter, primary - SM .....	P181041
Filter, safety.....	P119370
Gasket kit.....	X003538 .....9
Gasket washer.....	P105740
Gasket, body or cup.....	P017335
Gasket, cover.....	P016972
Inlet shroud .....	P102870
Mounting band .....	H000350 .....2
SafetySignal indicator.....	X004816
Spring clip & pin.....	X005555
Wing nut .....	P109062

### G160077 STG-PERIPHERAL

Body, lower .....	P115023
Clamp, body.....	P100780
Clamp, cup.....	P100789
Cover .....	P109153
Cover latch assembly .....	P017617
Dust cup.....	P100794 .....3
Dust cup, quick release .....	P107377
Dust cup, VacValve, horz .....	P103530
Dust cup, VacValve, vert.....	P104973
Filter, primary .....	P182039 .....3
Filter, primary-Donaldson Blue® ... DBA7039	
Filter, primary - SM .....	P181039
Filter, safety.....	P114931
Gasket kit.....	X003539 .....9
Gasket washer.....	P105740
Gasket, body or cup.....	P017336
Gasket, cover.....	P017367
Inlet shroud .....	P101759
Mounting band .....	H000351 .....2
Outlet band clamp.....	P148348
SafetySignal indicator.....	X004816
Spring clip & pin.....	X005555
Wing nut .....	P109062

### G161006 STG-PERIPHERAL

Body, lower .....	P115023
Clamp, body.....	P100780
Clamp, cup.....	P100789
Dust cup.....	P100794 .....3
Dust cup, quick release .....	P107377
Dust cup, VacValve, horz .....	P103530
Dust cup, VacValve, vert.....	P104973
Filter, primary .....	P182042 .....3
Filter, primary-Donaldson Blue® ... DBA7042	
Filter, primary - SM .....	P181042
Filter, safety.....	P128408
Gasket kit.....	X003539 .....9
Gasket washer.....	P105740
Gasket, body or cup.....	P017336
Gasket, cover.....	P017367
Inlet shroud .....	P101759
Mounting band .....	H000351 .....2
SafetySignal indicator.....	X004816
Wing nut .....	P109062

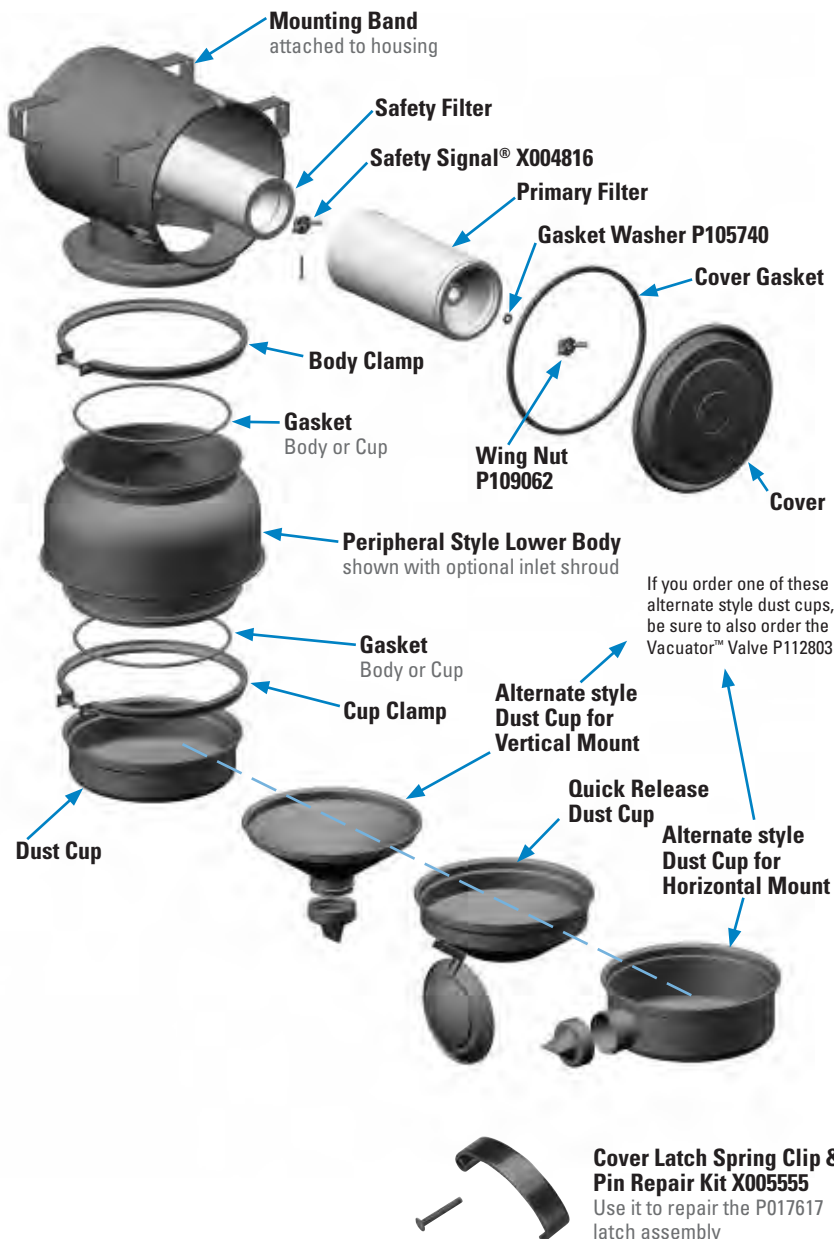

**NOTES:**  
 2 = Two required for proper installation  
 3 = Shipped with air cleaner initially  
 9 = Gasket Kit includes all gaskets listed

SM=Scheduled Maintenance  
 Donaldson Blue® = High Efficiency, Extended Service

**Simplify Service With Dust Dumpa Kits!**  
 If your current STG air cleaner has adequate clearance, one of the Dust Dumpa kits has the potential to save service time.

X006562 includes new gasket  
 Length 22.55" / 5723mm  
 Not for horizontal mounted air cleaners.

X006561  
 Length 16.54" / 420mm

**STG Tubular Service Parts**

**G120332 STG-TUBULAR**

Body, lower .....	P110875
Dust cup, quick release .....	P107375
Filter, primary .....	P182044 .....3
Filter, primary-Donaldson Blue®... DBA5044	
Filter, primary - SM .....	P181044
Filter, safety .....	P119371
Gasket washer .....	P105740
Gasket, body or cup .....	P017804
Gasket, cover .....	P017365
SafetySignal indicator .....	X004816
Spring clip & pin .....	X005555
Wing nut .....	P109062

**G140445 STG-TUBULAR**

Body, lower .....	P114100
Cover latch assembly .....	P017617
Dust cup .....	P100860 .....3
Filter, primary - SM .....	P181041
Filter, primary-Donaldson Blue®... DBA7041	
Filter, primary .....	P182041 .....3
Filter, safety .....	P119370
Gasket kit .....	X003538
Gasket washer .....	P105740
Gasket, body or cup .....	P017335
Gasket, cover .....	P016972
Mounting band .....	H000350 .....2
SafetySignal indicator .....	X004816
Spring clip & pin .....	X005555
Wing nut .....	P109062

**G160445 STG-TUBULAR**

Cover .....	P109153
Cover latch assembly .....	P017617
Dust cup .....	P100794 .....3
Dust cup, quick release .....	P107377
Dust cup, VacValve, horz .....	P103530
Dust cup, VacValve, vert .....	P104973
Filter, primary - SM .....	P181039
Filter, primary-Donaldson Blue®... DBA7039	
Filter, primary .....	P182039 .....3
Filter, safety .....	P114931
Gasket, body or cup .....	P017336
Gasket, cover .....	P017367
Gasket kit .....	X003539 .....9
Mounting band .....	H000351 .....2
Spring clip & pin .....	X005555

**G161020 STG-TUBULAR**

Dust cup .....	P100794 .....3
Dust cup, quick release .....	P107377
Dust cup, VacValve, horz .....	P103530
Dust cup, VacValve, vert .....	P104973
Filter, primary .....	P182042 .....3
Filter, primary-Donaldson Blue®... DBA7042	
Filter, primary - SM .....	P181042
Filter, safety .....	P128408
Gasket kit .....	X003539 .....9
Gasket washer .....	P105740
Gasket, body or cup .....	P017336
Gasket, cover .....	P017367
Mounting band .....	H000351 .....2
Mounting bands, metal .....	H000351
Outlet band clamp .....	P148347
SafetySignal indicator .....	X004816
Wing nut .....	P109062

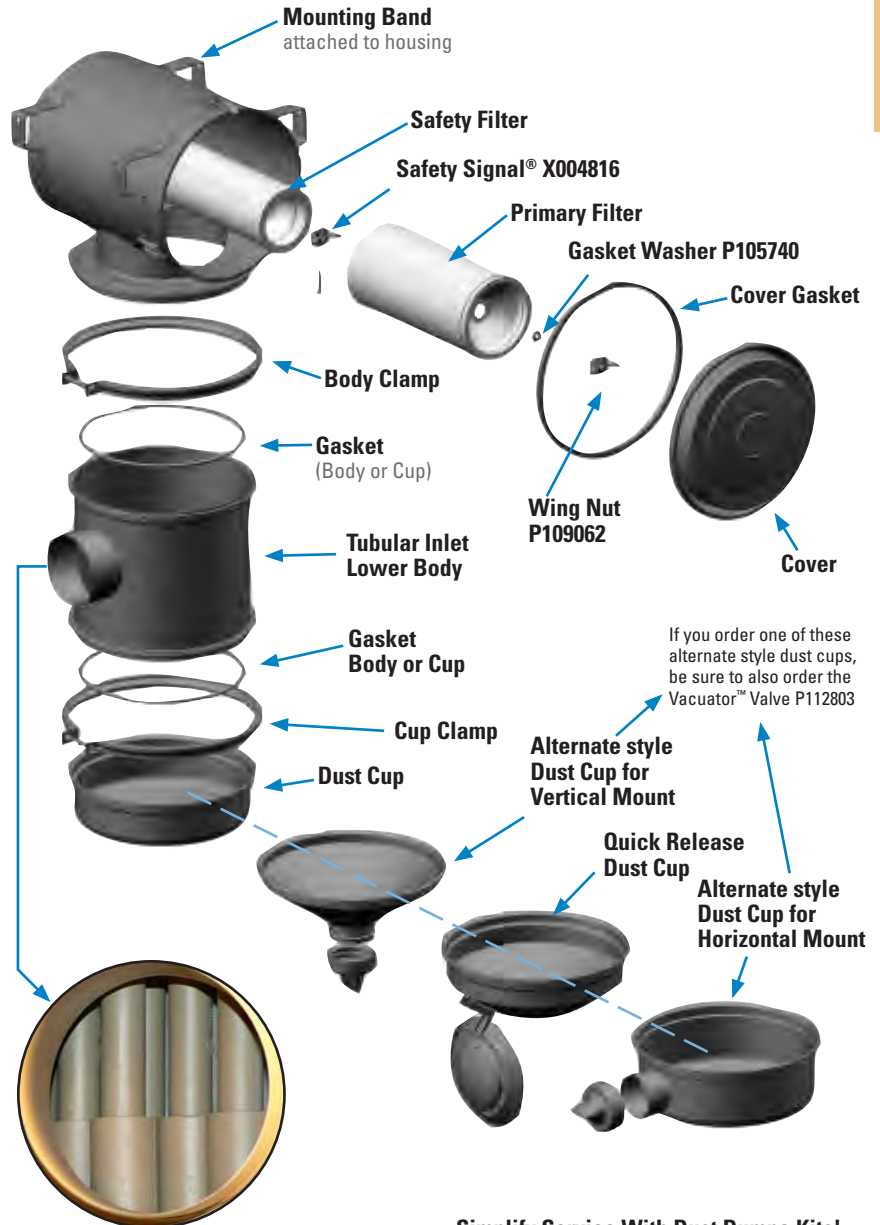

Inlet view of Donaclone™ pre-cleaning tubes inside the Lower Body Assembly.

**NOTES:**

- 2 = Two required for proper installation
- 3 = Shipped with air cleaner initially
- 9 = Gasket Kit includes all gaskets listed

SM=Scheduled Maintenance  
Donaldson Blue® = High Efficiency, Extended Service

**Simplify Service With Dust Dumpa Kits!**

If your current STG air cleaner has adequate clearance, one of the Dust Dumpa kits has the potential to save service time.



X006562 includes new gasket  
Length 22.55" / 5723mm  
Not for horizontal mounted air cleaners.



X006561  
Length 16.54" / 420mm





This servicing information is provided as a best practices guide. It is not intended to replace or supersede the service instructions supplied by your engine or vehicle manufacturer.

### 1 Check the Restriction

Replace the filter only when the restriction level has reached the maximum recommended by the engine or equipment manufacturer.



### 2 Empty the Dust Cup and Check the Vacuator™ Valves

Switch off the engine. The dust cup should be emptied when 2/3 full. Frequency of dust cup service varies with the dust severity.

On dust cups with a Vacuator Valve, dust cup service is minimal. Just check the Vacuator Valve to see that it is not inverted, damaged or plugged. If it is damaged or missing, replace it immediately.

Visually inspect gasket between dust cup and lower body — if worn or damaged, replace.

*Tip: Save Service Time — Install Dust Dumpa on Vertical STG Air Cleaners!*



If your STG Air cleaner has a dust cup with a Vacuator Valve that is inverted or looks like any of the images below replace it immediately.

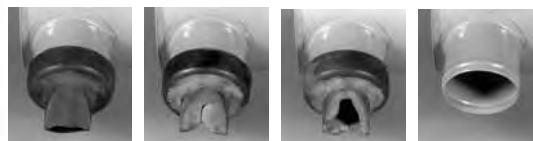

### 3 Inspect the Donaclone™ Pre-Cleaning Tubes

With the dust cup removed, check the tubes. Generally, the tubes are self-cleaning and need no service, but under unusual circumstances, plugging can occur. A visual inspection is usually adequate.

If the tubes carry light dust, remove it with a stiff brush. If plugging with fibrous material is evident, remove the Strata™ or Donaclone section. Clean it with compressed air or water no hotter than 160 °F / 72 °C.

Any time the Donaclone tube lower body is removed, the body gaskets should be replaced. When reinstalling the dust cup, be sure it seals 360° around the air cleaner body.

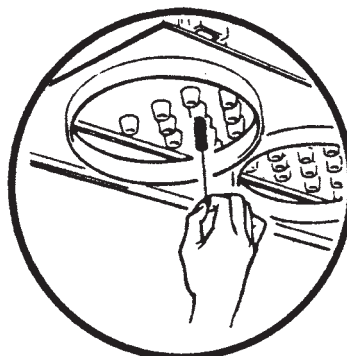

*Never clean Donaclone tubes with compressed air unless both the primary and safety filters are installed in the air cleaner.*

*Do not steam-clean Donaclone or Strata tubes.*

## 4 Remove the Primary Filter and Visually Inspect the Safety Filter

Unlatch the service cover to access the filters.

Loosen the wing nut and remove the primary filter. The wing nut on the old filter should be held in place with a clip. Visually inspect the safety filter but do not remove the filter unless it is damaged or due for change-out.

The safety filter should be replaced every three primary filter changes.

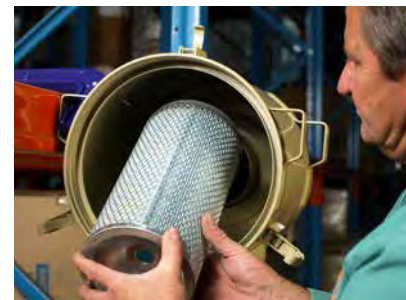

*Note: If you perform filter maintenance service on a schedule vs. using service indicators, you may want to write the service date on the filter end cap.*

*The safety filter should be replaced every three primary filter changes.*

## 5 Always Clean the Inside of the Filter Housing

Dirt left in the air cleaner housing can be harmful for your engine. Starting with the sealing surfaces, use a clean, damp cloth to wipe the inside surfaces clean. An improper gasket seal is one of the most common causes of engine contamination, so make sure that all hardened dirt ridges are completely removed.



*Continued on next page*





# STG Donaclone™ Air Cleaners

## Service Instructions



### 6 Install the New Filters

The safety filter should be replaced every three primary filter changes or as denoted by the SafetySignal™ service indicator. When replacing the safety filter, install the new filter immediately or cover the inlet with a cloth so that dirt is not ingested.

Before installing the new filters, inspect them for shipping damage and gasket integrity. If a filter is damaged, do not install it. If the safety filter is being replaced, and a SafetySignal is used, secure it in place with a cotter (split) pin.

Secure the primary filter in place with the wing nut (hand tighten) using a new gasket washer. Use a new wing nut clip and reset the filter service indicator.



### 7 Inspect Air Cleaner System

Finally, inspect and tighten all air cleaner system connections. If there are holes or damage, replace immediately. Inspect all air ducting for worn spots or damage. Annual replacement of air cleaner system gaskets is recommended.

## Convert Older SRG Housing to new SSG Housing Style to Save Maintenance Time and Costs



Replacing an older SRG housing with the new SSG housing allows you to simplify your routine filter service — no more separate gaskets at each filter change or removing a bolted on cover. SSG filters have RadialSeal™ end caps that provide a more reliable, consistent seal. Choose from an upper assembly conversion kit or you may want to install a complete new housing if your current SRG assembly needs repair or is reaching the end of its useful life.



**SRG29 Housing**



**Upper Body Conversion Kit**



**SSG29 Housing**



### Kit Order Information

SRG Housing Item No.	SRG to SSG Kit* Kit No.	SSG Housing Item No.
G200008	X009702	G200087
G200013	X009701	G200086
G290000	X009230	G290057
G290023	X009230	G290052
G290012	X009231	G290053

\* The finish on the replacement kit upper assembly is a white, powdered-coated paint. Installation instructions are included with the kit.

Note: Extra lead time may be required for processing and shipping.





This servicing information is provided as a best practices guide. It is not intended to replace or supersede the service instructions supplied by your engine or vehicle manufacturer.

### SERVICE TRAINING VIDEOS



<http://www.youtube.com/user/donaldsonengine>

Donaldson Service Training Videos are on YouTube. Scan the QR code or go to <http://www.youtube.com/user/donaldsonengine> to watch videos on how to service Donaldson Air Cleaners, like the SRG.

## 1 Check the Restriction

Replace the filter only when the restriction level has reached the maximum recommended by the engine or equipment manufacturer.



## 2 Empty the Dust Cup and Check the Vacuator™ Valves

Switch off the engine. The dust cup should be emptied when 2/3 full. Frequency of dust cup service varies with dust severity.

On dust cups with a Vacuator Valve, dust cup service is minimal. Just check the Vacuator Valve to see that it is not inverted, damaged or plugged. If it is damaged or missing, replace it immediately.

Visually inspect gasket between dust cup and lower body — if worn or damaged, replace.

*Tip: Save Service Time — Install Dust Dumpa on SRG Air Cleaner Installations!*



If your SRG Air Cleaner has a dust cup with a Vacuator Valve, replace it immediately if it is inverted or looks like any of the images below.



### 3 Inspect the Donaclone™ Pre-Cleaning Tubes

With the dust cup removed, check the tubes. Generally, the tubes are self-cleaning and need no service, but under unusual circumstances, plugging can occur. A visual inspection is usually adequate.

Any time the Donaclone tube lower body is removed, the body gaskets should be replaced. When reinstalling the dust cup, be sure it seals 360° around the air cleaner body.



View of Donaclone Tubes with Dust Cup removed.

If the tubes carry light dust, remove it with a stiff brush. If plugging with fibrous material is evident, remove the Strata™ or Donaclone section. Clean it with compressed air or water no hotter than 160 °F / 72 °C.

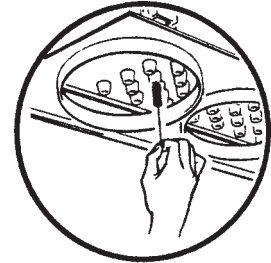

### 4 Remove the Primary Filter and Visually Inspect the Safety Filter

Unlatch the service cover to access the filters.

Loosen the wing nut and remove the primary filter. The wing nut on the old filter should be held in place with a clip. Visually inspect the safety filter but do not remove the filter unless it is damaged or due for change-out.



Continued on next page



### 5 Always Clean the Inside of the Filter Housing

Dirt left in the air cleaner housing can be harmful for your engine. Starting with the sealing surfaces, use a clean, damp cloth to wipe the inside surfaces clean. An improper gasket seal is one of the most common causes of engine contamination, so make sure that all hardened dirt ridges are completely removed.

Block the outlet tube of the air cleaner using a clean, dampened towel prior to proceeding with cleaning the inside of the housing to avoid contaminating the induction system.



### 6 Install the New Filters

The safety filter should be replaced every three primary filter changes or as denoted by the SafetySignal™ service indicator. When replacing the safety filter, install the new filter immediately or cover the inlet with a cloth so that dirt is not ingested.

Before installing the new filters, inspect them for shipping damage and gasket integrity. If a filter is damaged, do not install it. If the safety filter is being replaced, and a SafetySignal is used, secure it in place with a cotter (split) pin.

Secure the primary filter in place with the wing nut (hand tighten) using a new gasket washer. Use a new wing nut clip and reset the filter service indicator.

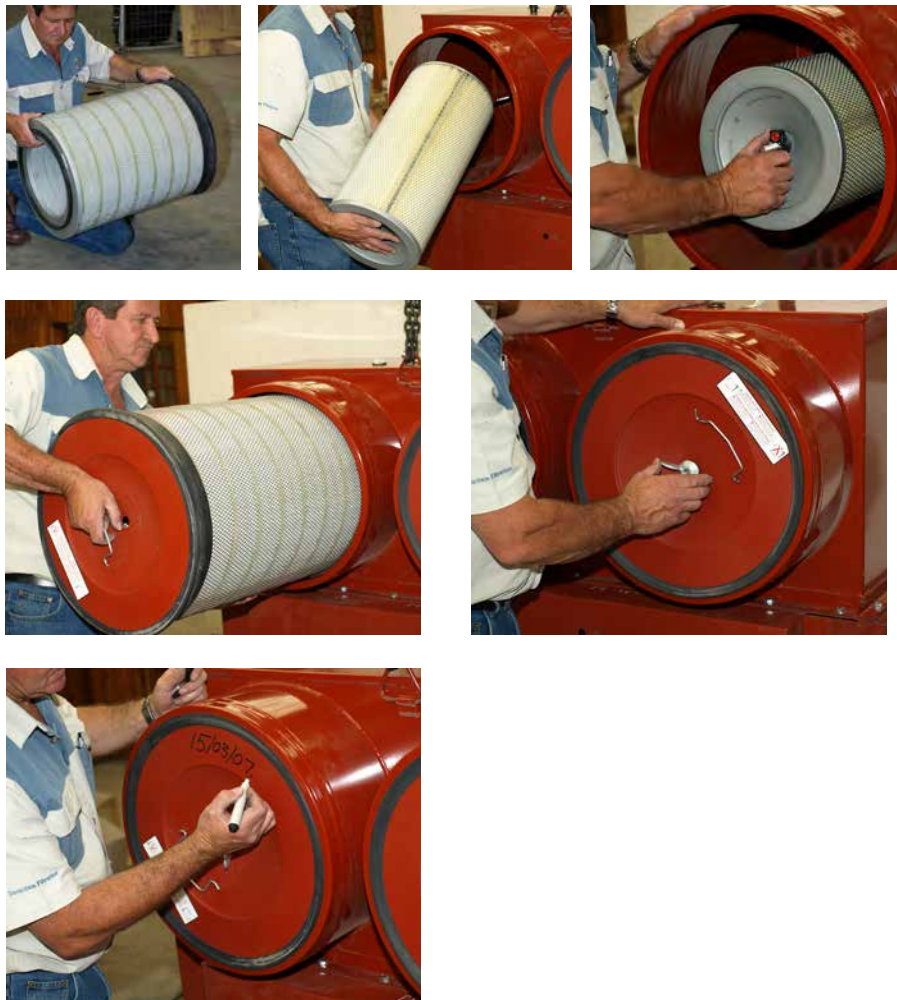



## 7 Inspect Air Cleaner System

Finally, inspect and tighten all air cleaner system connections. If there are holes or damage, replace immediately. Inspect all air ducting for worn spots or damage. Annual replacement of air cleaner system gaskets is recommended.

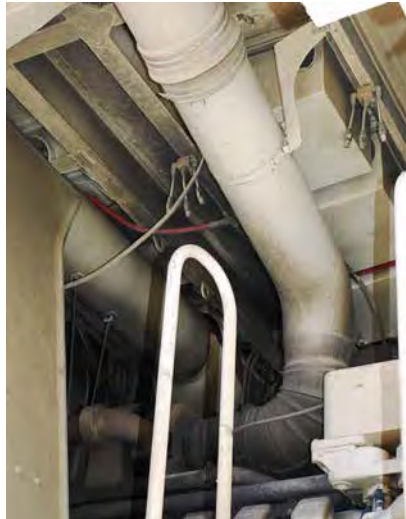

### SRG20 Service Parts

#### Primary Filter Choices

##### G200008

Filter, primary - SM ..... P181038  
 Filter, primary-Donaldson Blue® ... DBA7038  
 Filter, primary ..... P182038 ....3

##### G200013

Filter, primary - SM ..... P181040  
 Filter, primary-Donaldson Blue® ... DBA7040  
 Filter, primary ..... P182040 .... 3

### SRG29 Service Parts

#### Primary Filter Choices

##### G290000 & G290023

Filter, primary - SM ..... P181038  
 Filter, primary-Donaldson Blue® ... DBA7038  
 Filter, primary ..... P182038 ....3

##### G290012 Filters

Filter, primary - SM ..... P181040  
 Filter, primary-Donaldson Blue® ... DBA7040  
 Filter, primary ..... P182040 ....3

**NOTES:**

3 = Shipped with air cleaner initially

SM = Scheduled Maintenance  
 Donaldson Blue® = High Efficiency, Extended Service

## Changes That Can Save You Time and \$\$ After Converting to an SSG!

### Upgrade to Donaldson Blue® Filters

Donaldson Blue, ultra-high efficiency filters are available for the SSG product line. These filters have Donaldson's advanced Ultra-Web® HD Filtration Technology to protect your engines from submicron and mixed contaminant.



### Install Dust Dumpa

Dust Dumpa is a direct replacement to our dust cups. You can greatly reduce, if not eliminate, the routine step of emptying the dust cup — two models available X006561 [left] and X006562 [right].







## The All-in-One STB Strata™ System Air Cleaner and Pre-Cleaner In One Package

### Applications

- Allows 1050 to 1400 cfm airflow throughput per air cleaner
- For severe dust conditions, usually off-road applications: crawler tractors, scrapers, loaders, large agricultural tractors
- Horizontal installation

### Air Cleaner Features

- Air cleaner and pre-cleaner in one package (exhaust ejector, scavenge hose and clamps sold separately)
- Pre-cleaned dust is ejected with the engine exhaust through an aspirated muffler or exhaust ejector
- Airflow pattern "B" air through the pre-cleaner, out the end of the air cleaner
- Perfect for:
  - turbocharged engines
  - intercooled engines
  - naturally aspirated engines
- Fitting for filter service indicator on all models
- Finished in corrosion-resistant paint
- Weight: 78 lbs. (35.4 kg)



*The STB Strata™ System protects heavy-duty engines (like this one operating in severe dust conditions) with two-stage filtration and the convenience of aspirated dust ejection.*

*Ejector muffler, hose and clamps not included with B160071 — order parts separately.*

### Filter Features

- Two replacement filter choices: standard life filter for shops that service air cleaners on scheduled maintenance (shipped with STB initially), or extended life filter for those who measure restriction to obtain full filter life
- Safety filter on all models provide continuous protection during primary filter change out

*For installation instructions on the STB system, see the Technical Reference section.*

## How the STB System Works

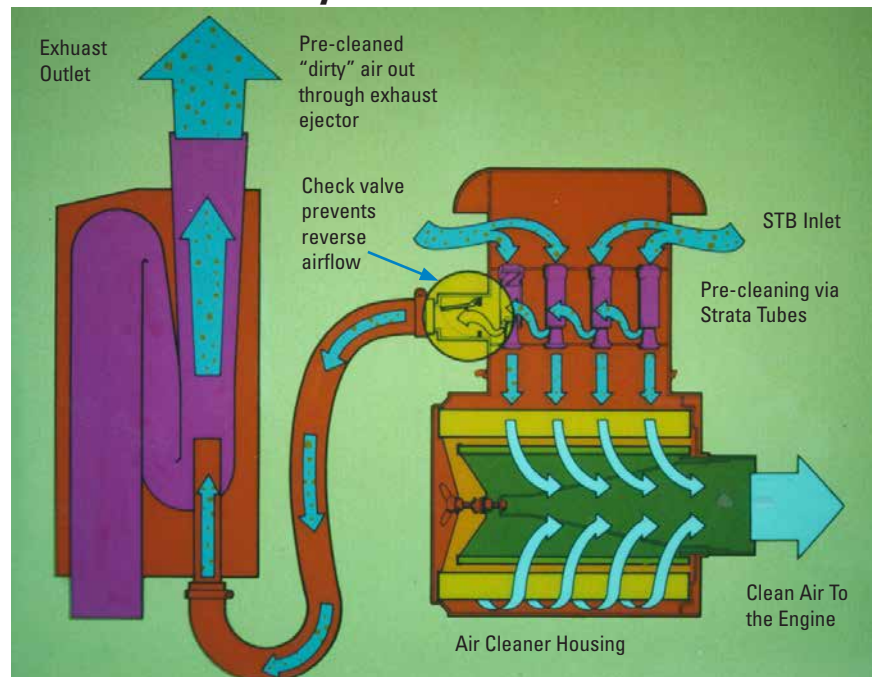

### When Selecting an Air Cleaner . . .

Determine the airflow requirements of your engine, then find the corresponding cfm airflow in the table at right. The restriction numbers (shown in inches of water) indicate the approximate initial restriction of each model air cleaner at that cfm. If there are two air cleaner models that fit your parameters, choosing the one with the lower restriction will provide longer filter service life. When calculating total initial restriction of the entire air intake system, include the restriction caused by ducting, elbows, and pre-cleaners. See pages 257-258 for ducting restriction estimates.

### Initial Airflow Restriction

6"	CFM @ "H <sub>2</sub> O		Air Cleaner Model
	8"	10"	
1050	1225	1400	B160071

### Airflow Pattern "B"

Air in through the pre-cleaner, out the end of the air cleaner (lower) portion.

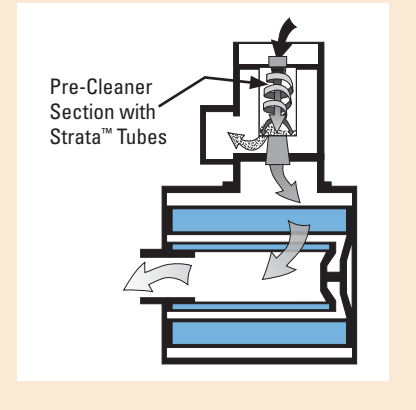

### STB Air Cleaner Performance Curve (Restriction & Dust Capacity)\*

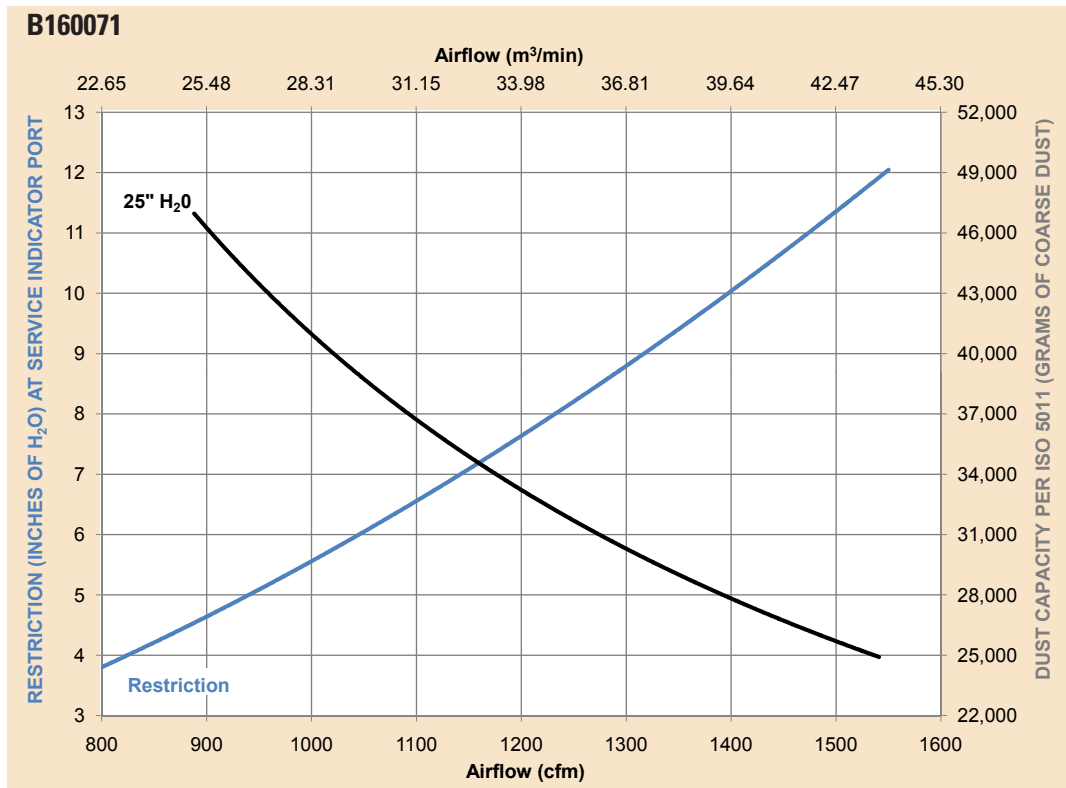

\*Results generated using laboratory testing pursuant to ISO5011. Actual performance during use may vary depending on multiple factors, including specific product configuration, external conditions and application.



## STB B160071 Specifications

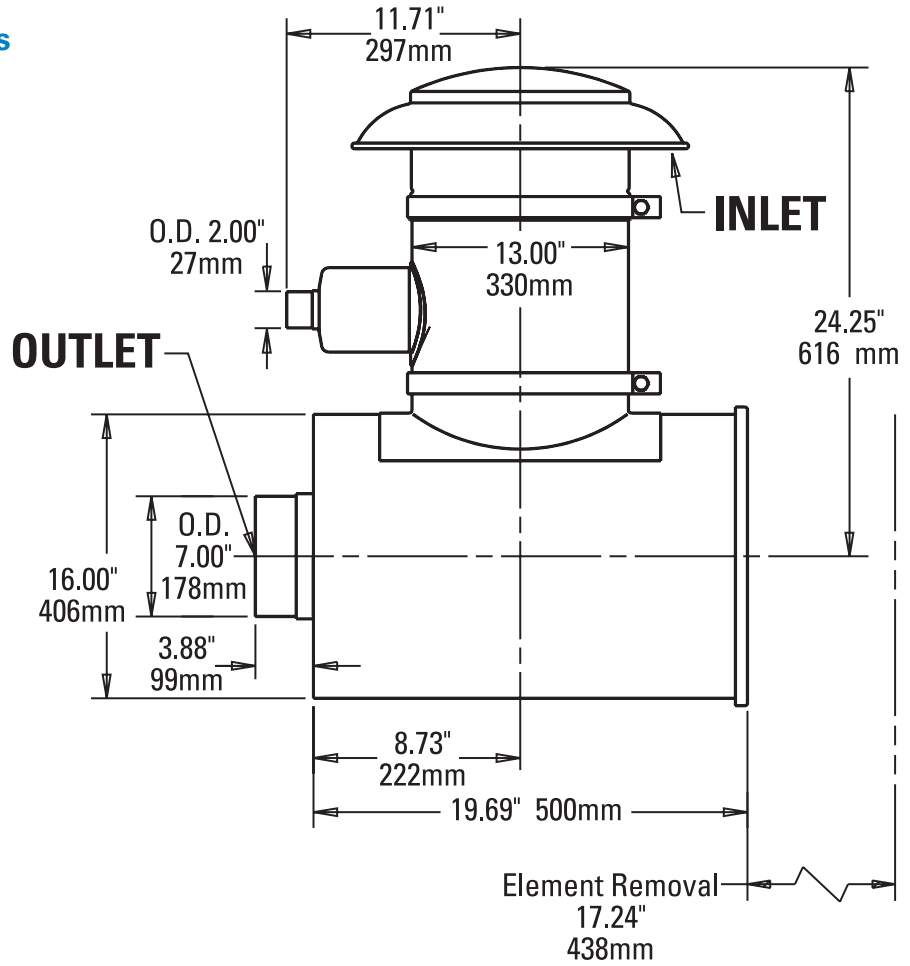

## B160071 Service Parts

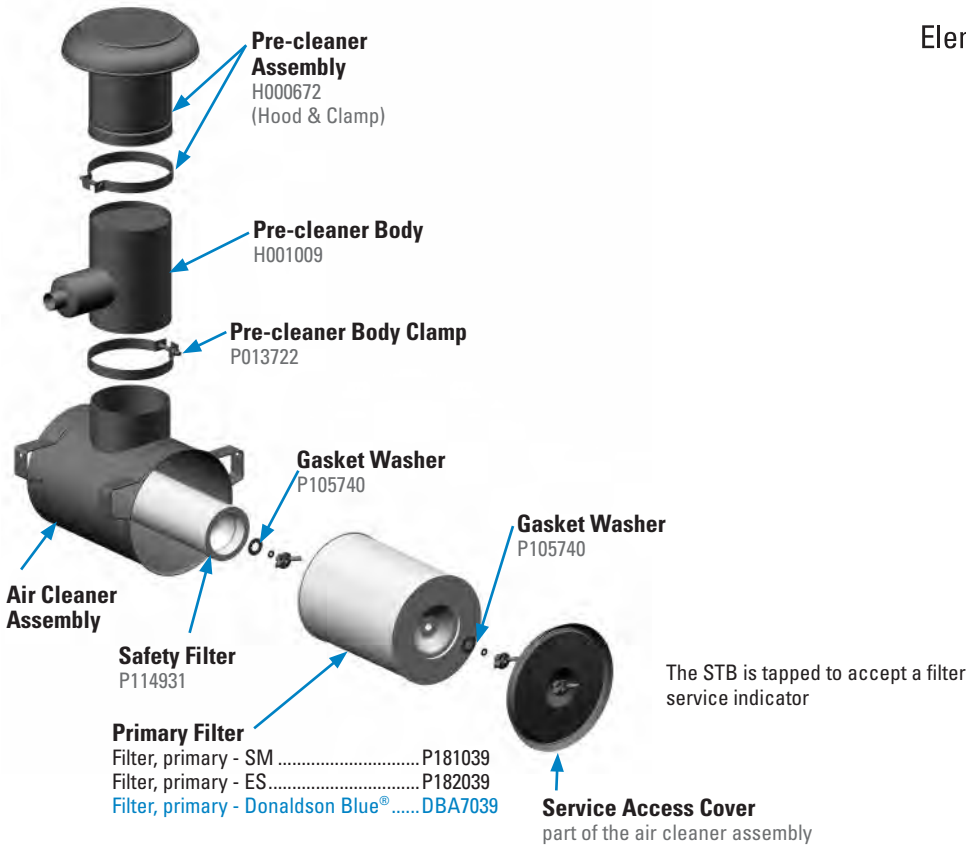

SM = Scheduled Maintenance  
 ES = Extended Service  
 Donaldson Blue® = High Efficiency, Extended Service

### Accessories Help You . . .

#### Set a Filter Service Schedule:

- Restriction indicators — go-no-go, lock-up styles, electric, in-field manometers, safety filter indicator. Product line now includes **Filter Minder®**

#### Aspirate (or scavenge) an intake system:

- Strata™ Cap
- Donaspin™
- Exhaust Ejectors
- Air Stack Extension
- Check Valve

#### Evacuate air cleaner dust:

- Vacuator™ Valves
- Quick Release Dust Cups
- Dust Dumpa
- Donaspin™
- STB Air System

#### Solve air intake water problems:

- Air Ram™ Inlet Hood
- In-line Moisture Skimmer
- In-line Moisture Separator
- Stack Top Moisture Eliminator

#### Pre-clean or protect air inlet from debris:

- Pre-cleaners
  - Strata™ Cap
  - TopSpin™ Pre-Cleaner
  - TopSpin™ HD Pre-Cleaner
  - Full-View Pre-Cleaner
  - In-line Separator
  - Donaspin™
- Air Ram™ Inlet Hood
- Inlet Hoods

#### Connect intake components:

- Rubber Elbows and Connectors
- Clamps
  - Aluminum Tubing
  - Rubber and Silicone Hump/Reducers
  - Charge Air Connectors

#### Mount or install an air cleaner:

- Mounting Bands
- Straight Pipe



### Section Index

Pre-Cleaners .....	178
Strata™ Cap .....	180
TopSpin™ .....	184
TopSpin™ HD .....	186
Full-View .....	188
Donaspin™ .....	190
In-Line Separators .....	191
Inlet Hoods / Rain Caps .....	192
Air Cleaner Mounting Bands .....	194
Hose & T-Bolt Clamps .....	195
Filter Service Indicators, Switches and Sensors .....	196
Rubber Elbows & Connectors .....	206
Charge Air Connectors .....	209
Vacuator™ Valves .....	210
Dust Dumpa Tube Extensions .....	212
Exhaust Ejectors .....	214
Ejector Check Valves .....	215
Inlet Hood, Air Ram™ .....	216
Moisture Skimmer .....	217
Moisture Eliminator .....	217
Air Stack Extensions .....	218
Intake Tubing .....	218
Breathers .....	218



## No Matter What Dust Condition, Pre-cleaners Extend Air Filter Life

Pre-cleaners remove contaminant of varying sizes from entering the intake duct, and they don't require any engine power to operate. Some devices collect the contaminant (Full-View), others just eject or drop the contaminant (TopSpin™, TopSpin™ HD, in-line separator), or are connected via a scavenge system and route debris out the exhaust system (Donaspin, Strata™ Cap).

### Product Offering

- Six pre-cleaner styles offer the broadest product range in the industry
- Strata™ Cap is the new scavenge system option for operating in heavy dust environments
- TopSpin™ HD is the new all-metal option for heavy-duty applications where a rugged and durable pre-cleaner is needed
- Pre-cleaners extend life of vehicle air filters and serve as rain caps
- Units are made of durable materials — either metal or impact resistant plastic
- Most units install outside of engine compartment — leaving more space under hood for other components (exception-in-line separator)
- No wires or power requirements
- Please note: Strata Cap and Donaspin require additional components for scavenge system — hoses, check valves, clamps and exhaust ejector

### To Scavenge or Not To Scavenge . . .

Air cleaners are designed to operate with or without aspiration. Aspiration (otherwise known as scavenging) is accomplished by introducing a secondary airflow in the intake ducting (generally through the use of an exhaust ejector or ejector muffler). This secondary airflow pulls the separated contaminant from the pre-cleaner and ejects it into the exhaust stream.



The advantages to scavenging are:

- Higher pre-cleaner efficiency (resulting in longer primary filter service life)
- Completely self-servicing (no regular maintenance needed on pre-cleaner)
- Drop tube can be located in a variety of orientations (not just straight down as is necessary on non-scavenged systems)

Aspirating an intake system through the use of a scavenging device adds more components (an ejector and some plumbing) to the overall system, but will enhance the separator efficiency of the pre-cleaner and consequently extend the primary filter service life.

### An alternative . . . Air Cleaners with Built-in Pre-Cleaning

Before you decide on adding a pre-cleaner. Take a look at our PowerCore® air cleaner housings — the PowerCore PSD Series. PowerCore air cleaners have a pre-cleaning section built directly into the housing. If you have the room, choosing a PowerCore air cleaner will reduce the number of components in your intake system — fewer parts to track, maintain and manage. And, some PSD air cleaner models can also be used in scavenged systems.

See the PowerCore PSD Series section, beginning on page 30, for more information.

### Selection

Select the style that matches dust conditions, airflow and desired efficiency level. Each pre-cleaner family is presented on the following pages.

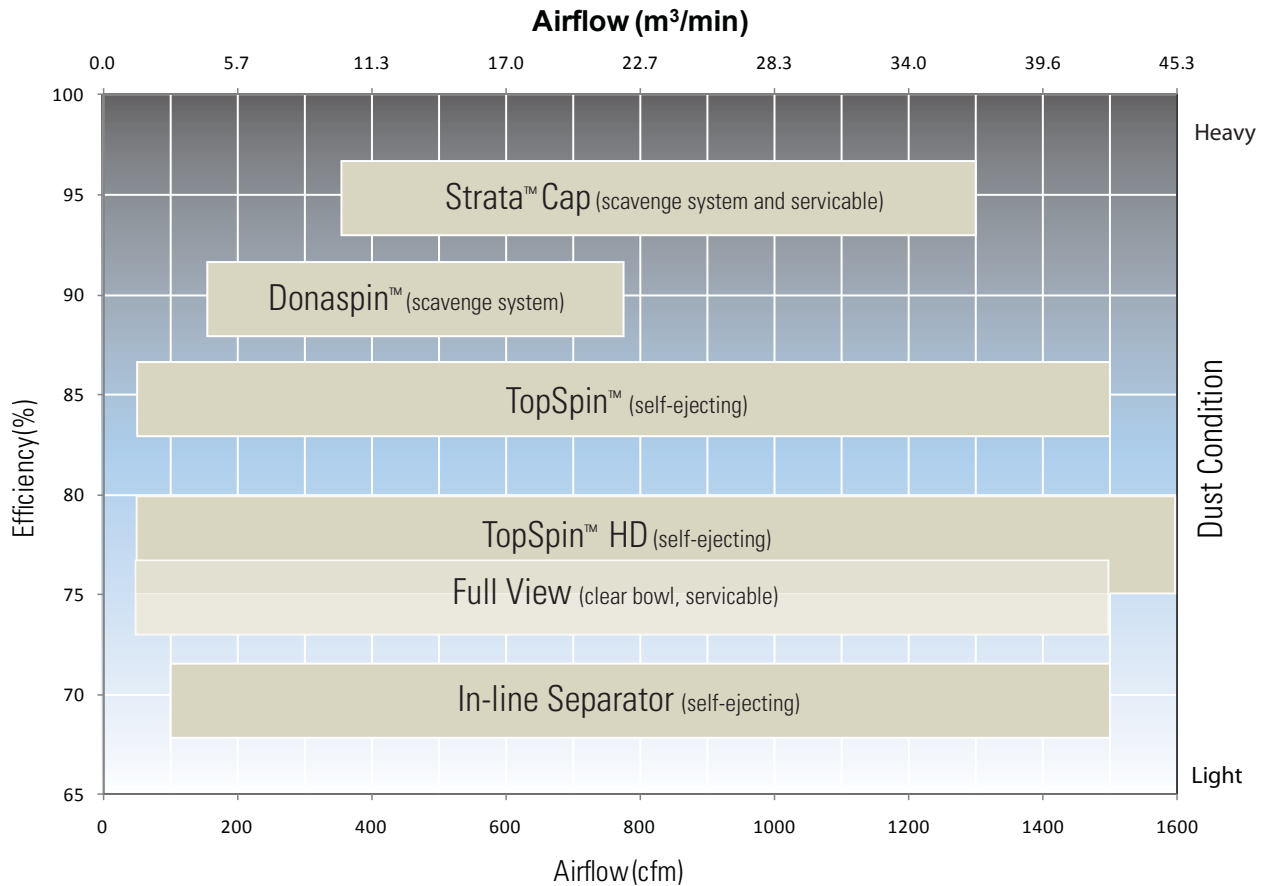

### Compare – Weight, Scavenge, Service and Materials

Additional characteristics about our pre-cleaner line to help you decide on the style that’s best for you.

Dust Condition	Max. Septr Efficiency	Unit Weight Range lbs.	Unit Weight Range kg.	Pre-Cleaner Family	Scavenge Required	Service Required	Material
Heavy	96%	6.2 – 9.1	2.82 – 4.14	Strata™ Cap	Yes	Yes	Plastic
	90%	8.0 – 10.0	3.63 – 4.54	Donaspin™	Yes	No	Steel
Medium	85%	1.0 – 6.0	0.45 – 2.72	TopSpin™	No	No	Plastic
	80%	1.0 – 9.5	0.5 – 4.3	TopSpin™ HD	No	No	Aluminum/ Stainless Steel
Light	70%	11.5 – 14.8	5.23 – 6.70	In-Line Separator	No	No	Steel
	75%	0.8 – 9.2	0.37 – 4.17	Full-View	No	Yes	Steel/Plastic

## Low Profile Pre-cleaner and Rain Cap in One!

The scavenged Strata™ Cap pre-cleaner removes up to 96% of incoming contaminant — the highest efficiency compared to all other Donaldson pre-cleaners. It is designed for the most demanding heavy dust environments in the construction and mining industry.

### Features

Separates up to 96% of incoming contaminant per ISO 5011/SAE J726

- Significantly extends air filter life
- Reduces air filter servicing and replacement
- Lowers cost per operating hour
- Separates more than 99% of 20 micron and above particles

Low profile for maximum operator visibility

Robust design for heavy-duty environments

- No moving parts
- Both a rain cap and pre-cleaner
- No bowl to clean or empty
- UV resistant plastic construction

Simple installation

- Unit installs outside of engine compartment, leaving more space under hood for other components
- No wires or power requirements
- Requires additional standard components for scavenge

Lighter Weight

- Low profile
- Lighter weight compared to other Donaldson scavenge systems; e.g., STB System and Donaspin™ pre-cleaner

### Application

- Accommodates a range of airflows from 350 to 1,300 cfm (9.9-36.8 m<sup>3</sup>/min).
- Primarily used in heavy dust environments
- Great for off-road vehicles and equipment from crawler tractors to farm tractors to skid steer loaders
- Recommended mounting: outside of engine compartment on top of the air cleaner inlet stack



*The scavenged Strata™ Cap pre-cleaner removes up to 96% of incoming contaminant — the highest pre-cleaning efficiency ever invented by Donaldson.*



### Advantages of Scavenging

Scavenging is accomplished by introducing a secondary airflow to the drop tube on the air cleaner (generally through the use of an ejector or ejector muffler). This flow pulls the separated contaminant from the pre-cleaner and inserts it into the exhaust stream.

- Higher pre-cleaner efficiency (resulting in longer filter service life)
- Completely self-servicing (no regular maintenance needed on pre-cleaner)

Aspirating an intake system through the use of a scavenging device adds more components (an ejector and some plumbing) to the overall system, but will enhance the separator efficiency of the pre-cleaner and consequently extend the filter service life.

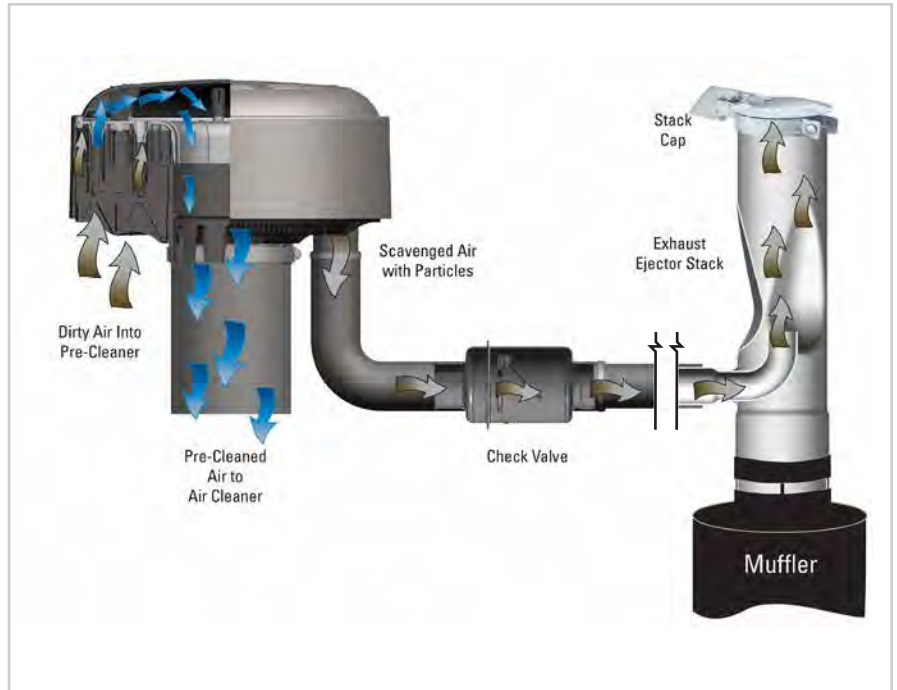

### Performance — Restriction at 10% Scavenge

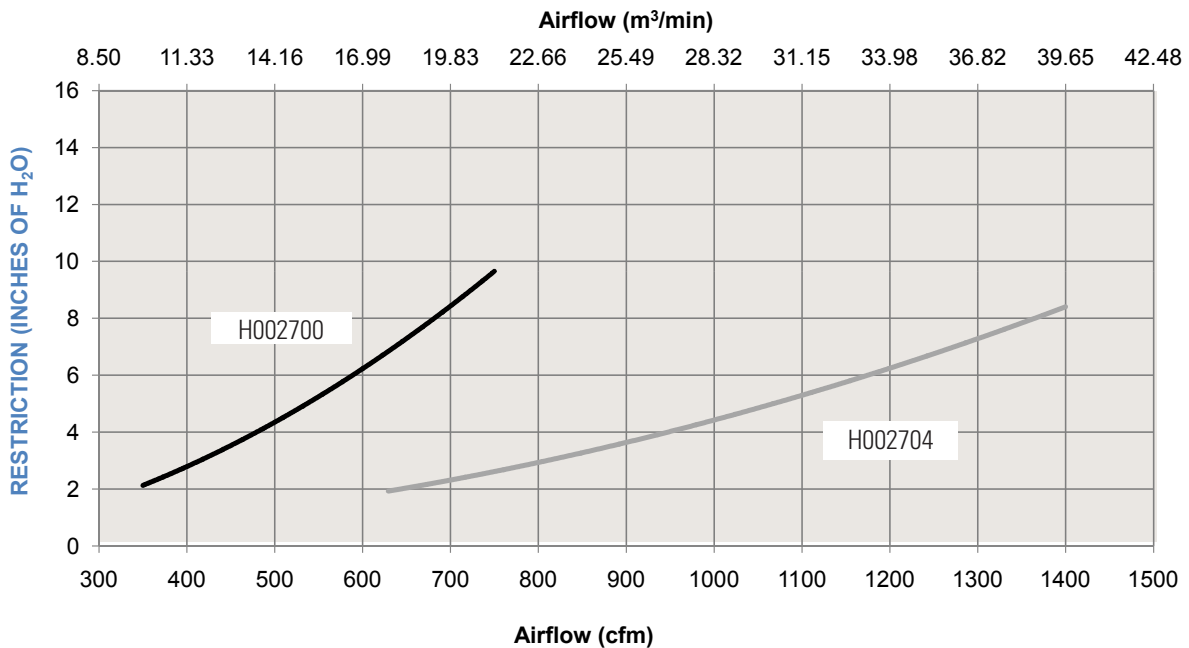



## Performance – Initial Efficiency at 10% Scavenge

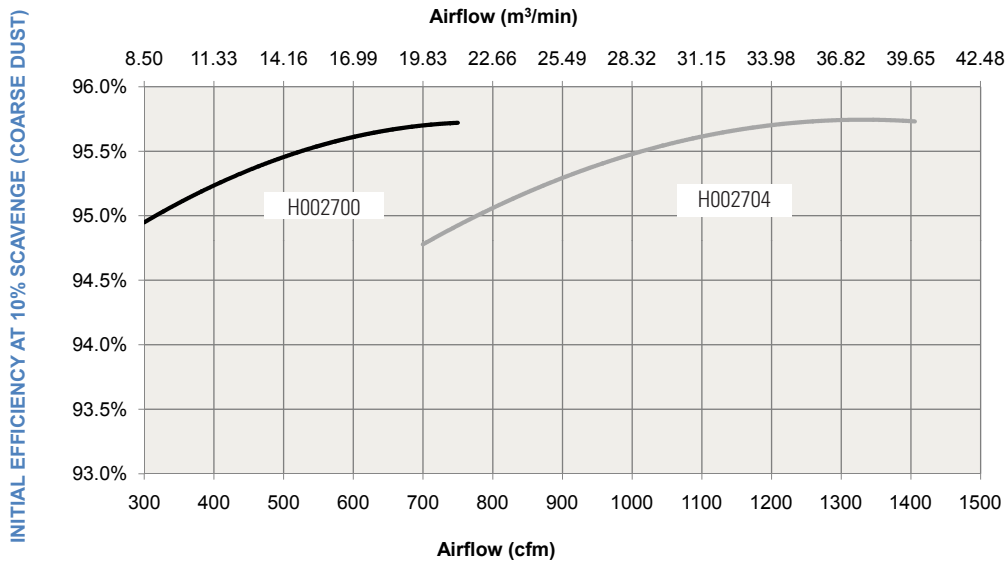

## Dimensional Specifications



Part Number	Overall Height (A)		Body Dia. (B)		Outlet I.D. (C)		Scavenge Hose I.D. (D)		Weight lbs.	Weight kg.	Rated Air Flow @ 6" H <sub>2</sub> O
	in	mm	in	mm	in	mm	in	mm			
H002700	8.00	218	14.00	356	5.00	127	2.00	51	6.2	2.8	600 cfm / 17.0 m³/m
H002704	8.60	218	17.20	437	8.00	203	2.00	51	8.8	4.0	1140 cfm / 32.3 m³/m

## Installation

For proper function, the pre-cleaner/rain cap installs over a 5.0" or 8.0" OD metal intake tube and connects to a 2.0" I.D. scavenge hose. The scavenge hose should be secured from movement within 12.0" / 305mm of the pre-cleaner/rain cap.

Additional components are required for proper installation:

- Scavenge hose (2.0" / 51mm I.D.) need enough for two cut lengths connecting to the Strata™ Cap to check valve and the check valve to exhaust ejector
- Hose clamps (x 4) (Part No. P115200)
- Check Valve (Part No. H000722)
- Metal Intake Tube (O.D.) to mount Strata™ Cap to Air Cleaner (5.0" / 127mm or 8.0" / 203mm Dia. — depends on your Strata™ Cap size)
- Standard and expanded I.D. exhaust ejectors available

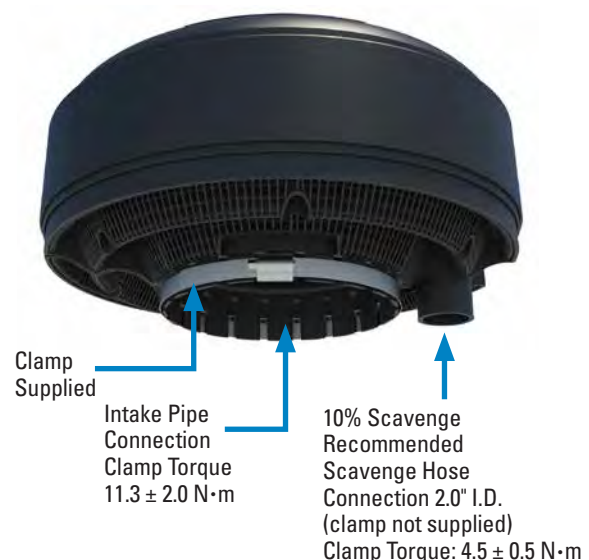

## Service Procedure

The pre-cleaner/rain cap may need to be cleaned over time. The procedure below recommends removal and disassembly of the unit to clean. The unit can be cleaned with either water, mild-soapy water or compressed air. Tapping or hitting the components to dislodge contaminant should be avoided. It may cause damage and prevent reassembly.

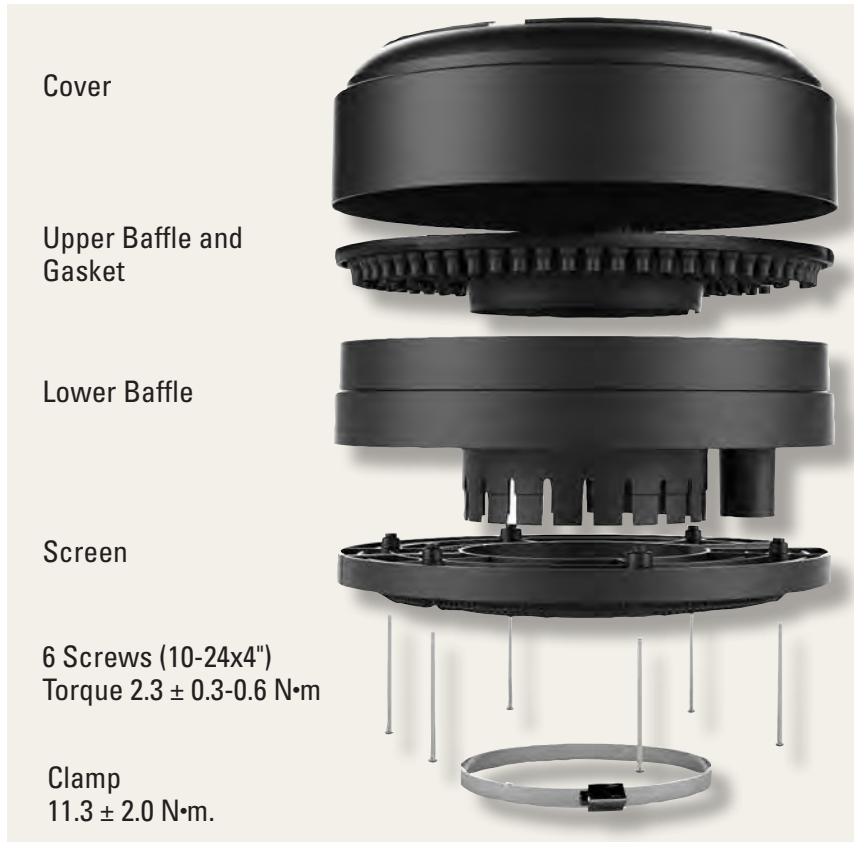

1. Turn off engine.
2. Loosen both connecting clamps (metal pipe and scavenge hose) and remove the Strata™ Cap pre-cleaner.
3. Turn unit upside down. Remove the screws (save for reassembly) and disassemble the unit (screen is two pieces).

*Note: Cover or plug intake pipe to protect air intake system from contamination during service.*

4. Clean all the parts to remove dust and debris from each component.
5. After cleaning, inspect the gasket on the perimeter of the upper baffle. If damaged in any way replace with new gasket. Check gasket position, make sure it is installed evenly around upper baffle perimeter.

*Note: Using the unit without gasket properly installed will affect Strata™ Cap pre-cleaning performance.*

## Service Parts

Strata™ Cap Model No.	Gasket	1/2 Screen
H002700	P617476	P617922
H002704	P167475	P617923

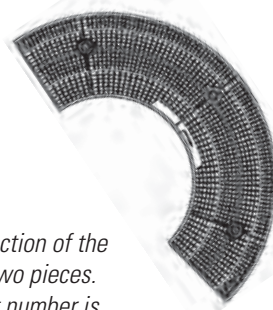

*Entire screen section of the Strata™ Cap is two pieces. The service part number is one screen only.*

6. With cover upside down, reassemble components. Unit has alignment guides to aide reassembly.
7. With all components together, reinstall and torque the 6 screws to  $2.3 \pm 0.3-0.6 \text{ N}\cdot\text{m}$

*Note: Removable screw adhesive is to be used on the screws if original blue patch has been worn off.*

8. Replace Strata™ Cap on intake stack, reconnect scavenge hose. Tighten clamps to torque specifications. If scavenge support was disconnected, reconnect.

## TopSpin™ Can Extend Filter Life in Heavy Dust Conditions

Donaldson TopSpin™ will extend primary air filter life, boost system efficiency, and extend engine life.

### Features

Separates up to 85% of incoming contaminant per ISO 5011/SAE J726

- Greatly extends air filter life
- Reduces air filter usage
- Lowers cost per operating hour
- Automatically ejects mixed debris
- Separates more than 99% of 20 micron and above particles

### Self-cleaning/self-scavenging

- No maintenance to clean bowl
- No exhaust ejector required

### Easy installation

- Quick installation
- One clamp to tighten
- No wires or power requirements

### Dual mounted bearings

- More robust design
- Extends bearing life

### Lighter Weight

- Lighter than competitive pre-cleaners
- Lighter than Donaldson full-view pre-cleaner

### Application

- Engine airflows of 80 to 1500 cfm (2.3-42.5 m<sup>3</sup>/min).
- Primarily used in medium to heavy dust environments
- Great for off-road vehicles and equipment from crawler tractors to farm tractors to skid steer loaders
- Recommended mounting: on top of the air cleaner inlet stack



**Donaldson TopSpin™ in Action**  
**Upper left**, TopSpin on excavator; **upper right**, military ground vehicle in middle east; **left**, TopSpin on pumper truck in Australia.

### How it Works:

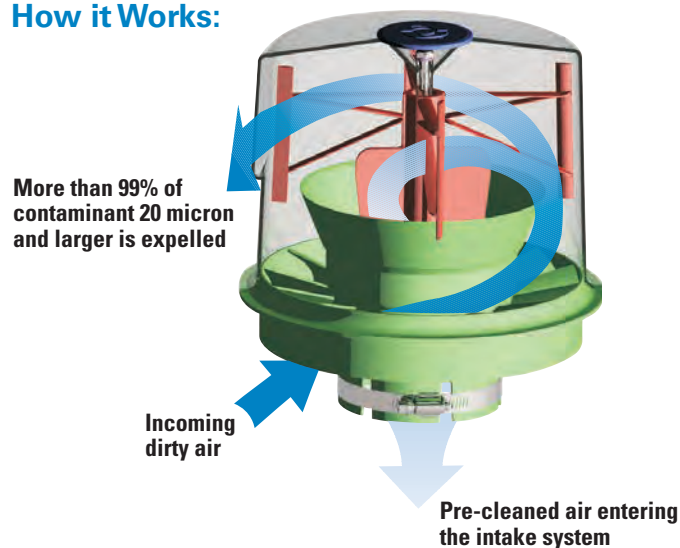

## Performance Curves

Multiple tests conducted per ISO 5011/SAE J726 and average results are shown in charts below.

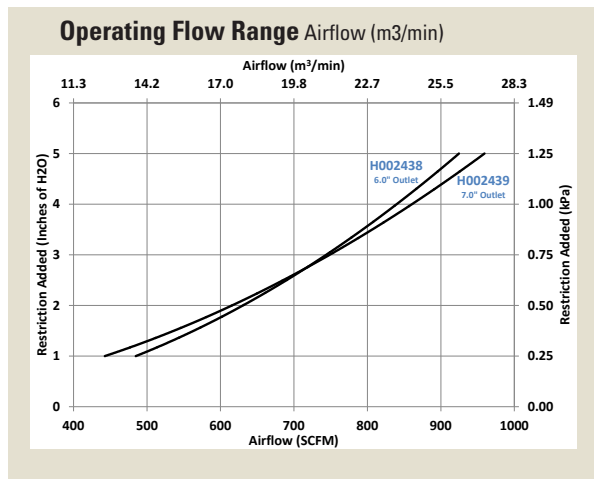
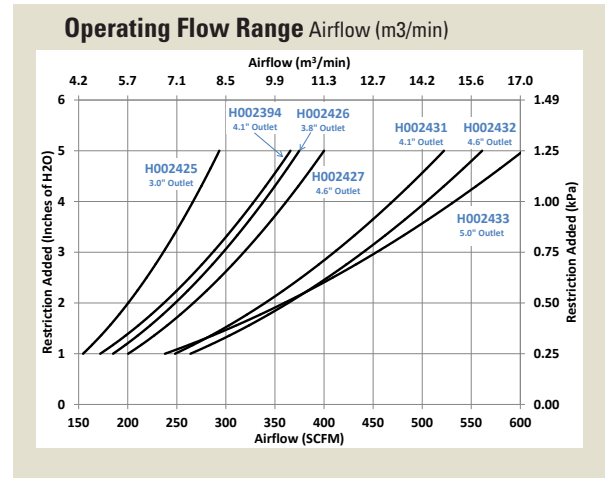
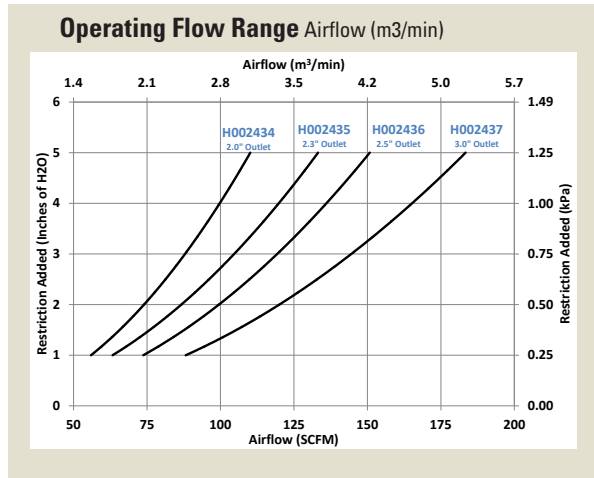

## Dimensional Specifications

Donaldson TopSpin™ can be mounted horizontally or vertically. Installation instructions, stainless clamp and warranty are included. Operating temperature range: -40 °F to 180 °F (-40 °C to 82 °C)

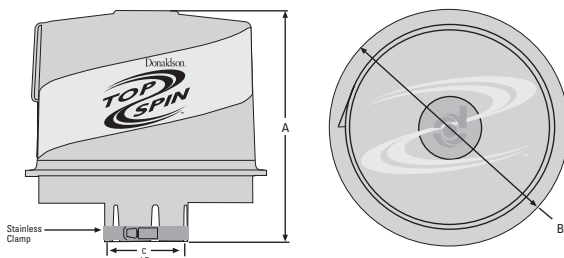

Part Number	Overall Height (A)		Body Dia. (B)		Outlet I.D. (C)		Weight	
	in	mm	in	mm	in	mm	lbs.	kg.
H002434	5.75	146	6.38	162	2.03	52	1.0	0.4
H002435	5.75	146	6.38	162	2.27	58	1.0	0.4
H002436	5.75	146	6.38	162	2.53	64	1.0	0.4
H002437	5.75	146	6.38	162	3.03	77	1.0	0.4
H002425	9.39	238	9.51	242	3.07	78	2.2	1.0
H002426	9.39	238	9.51	242	3.83	97	2.2	1.0
H002394	9.39	238	9.51	242	4.06	103	2.2	1.0
H002431	11.30	287	11.32	288	4.06	103	2.7	1.2
H002427	9.39	238	9.51	242	4.57	116	2.2	1.0
H002432	11.30	287	11.32	288	4.57	116	2.7	1.2
H002433	11.30	287	11.32	288	5.03	128	2.7	1.2
H002438	13.57	345	15.62	397	6.03	153	6.0	2.7
H002439	13.57	345	15.62	397	7.03	179	6.0	2.7



## All-Metal Pre-cleaner is Durable Solution for Punishing Conditions

Donaldson TopSpin™ HD will extend primary air filter life, boost system efficiency and extend engine life in medium to heavy dust environments.

### Features

Separates up to 80% of incoming contaminant per ISO 5011

- All-metal construction
- Greatly extends air filter life
- Reduces air filter usage
- Lowers cost per operating hour
- Automatically ejects mixed debris

### Self-cleaning/self-scavenging

- No maintenance to clean bowl
- No exhaust ejector required

### Easy installation

- Quick installation
- One clamp to tighten
- No wires or power requirements

### Application

- Engine airflows of 50 to 1600 cfm (1.4-45.3 m<sup>3</sup>/min).
- Primarily used in medium to heavy dust environments
- Great for off-road vehicles and equipment, including crawler tractors, farm tractors, skid steer loaders, mining, and fracking machines
- Recommended mounting: on top of the **metal** air cleaner inlet stack. Do not mount on non-metal inlet stack



## Built as tough as your equipment

Rugged one-piece **aluminum hood** with recessed discharge louver sheds flying debris.

One-piece **stainless steel impeller** is the only moving part. Dual bearings ensure reliable performance.



**Stainless steel clamp** with locking nut makes installation quick and secure. Clamp is included with each TopSpin HD.

All the interior components are solid stainless steel to resist dirt, water, heat, and debris encountered in demanding environments.



## TopSpin HD Performance Curves

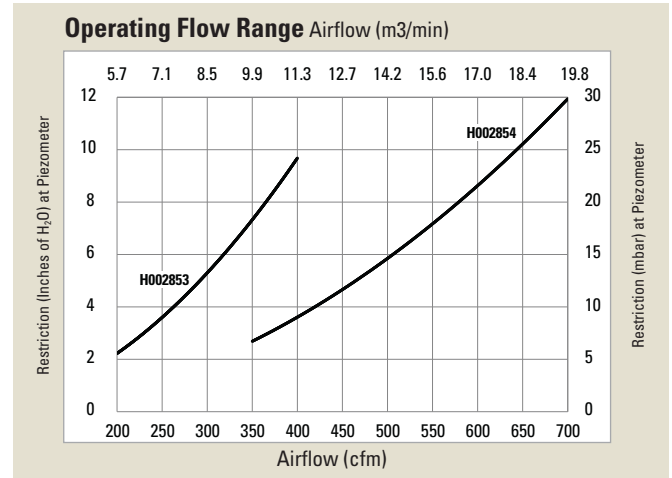
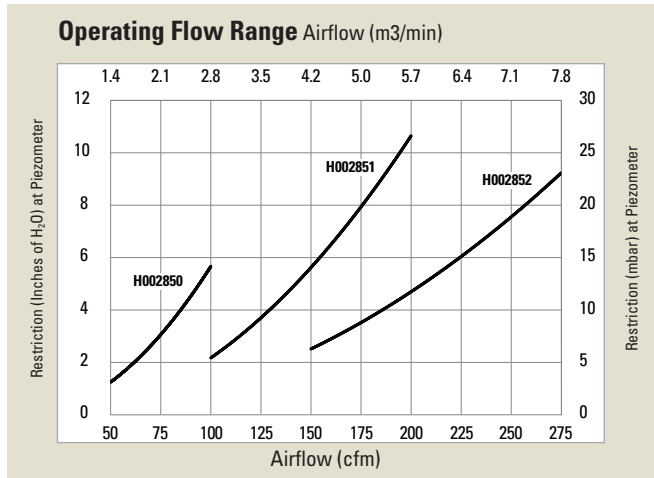

## Dimensional Specifications

Donaldson TopSpin™ HD can be mounted in an upright position or horizontally with louver opening at the bottom. Installation instructions, stainless steel clamp and limited lifetime warranty are included. Operating temperature range: -40 °F to 180 °F (-40 °C to 82 °C).

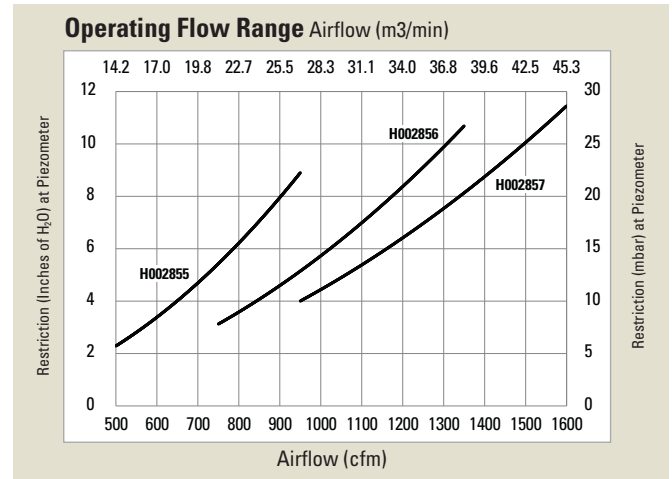
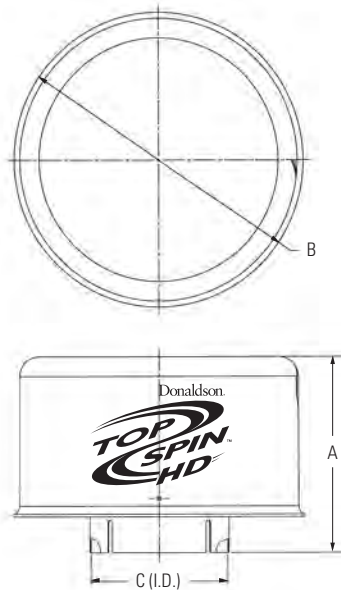

Part Number	Overall Height (A)		Body Dia. (B)		Outlet I.D. (C)		Operating Flow Range		Weight	
	in	mm	in	mm	in	mm	SCFM*	m3/min.	lbs.	kg.
H002850	3.41	86.5	5.4	137.2	2.06	52.3	50-100	1.4-2.8	1.0	0.5
H002851	4.25	108	6.3	160	2.58	65.5	100-200	2.8-5.6	1.75	0.8
H002852	4.96	125.9	7.2	182.9	3.07	78	150-275	4.2-7.8	2.75	1.2
H002853	5.81	147.6	8.72	221.6	4.10	104.1	200-400	5.6-11.3	3.75	1.7
H002854	7.56	192.1	11.19	284.2	5.08	129	350-700	10-20	6.5	3.0
H002855	7.72	196	12.78	324.6	6.10	154.9	500-950	14-27	7.25	3.3
H002856	8.38	212.7	14.75	374.6	7.10	180.3	750-1350	21-38	9.5	4.3
H002857	8.38	212.7	14.75	374.6	8.08	205.2	950-1600	26.6-44.8	9.5	4.3

Cross reference from a Full-View pre-cleaner to a TopSpin™ HD pre-cleaner can be found on the Full-view Pre-cleaner page.

\*SCFM = Standard Cubic Feet per Minute. The ISO 5011/SAE J726 test procedure was used to extract the results in the charts above. The ISO 5011/SAE J726 is a widely accepted industry test used by OEMs to evaluate the efficiency of the intake system components. Test results are an average from testing several units.

## Full-View Pre-Cleaner Helps Extend Filter Life on Agricultural & Construction Equipment

### Features

- Recommended mounting: on top of the engine intake stack
- Centrifugal force in bowl separates up to 75% of incoming dust **before** it enters the engine air intake system
- Low maintenance
- Durable, lightweight, noncorrosive construction
- Full-view plastic bowl lets operator easily see when service is needed
- One-bolt cover retention for easy service. When dirt reaches the level of the arrow, remove top nut and plastic body, then empty — no tools required
- Mounting clamp included



### Tired of Emptying the Cup?

Before you consider replacing your full-view pre-cleaner with another one, check out the TopSpin™ and TopSpin™ HD models on the previous pages.



### Pre-cleaner Upgrade Path

Full-View	TopSpin	TopSpin™ HD
H000820.....	H002425	
H000821.....	H002426	
H000858.....	H002394.....	H002853
H000823.....	H002427	
H001250.....	H002435	
H001251.....	H002436.....	H002851
H001249.....	H002437.....	H002852
H001823.....	H002434.....	H002850
H002043.....	H002433.....	H002854
H002044.....	H002432	
H002045.....	H002431	
H002223.....	H002438.....	H002855
H002224.....	H002439.....	H002856
N/A	N/A	H002857

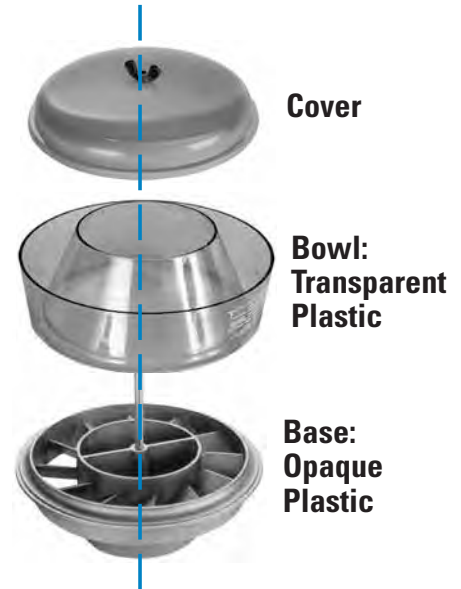
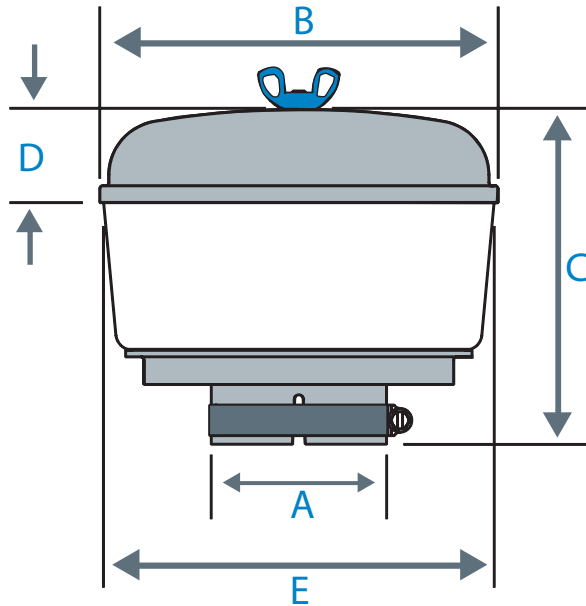

### Full-View Pre-Cleaners Specifications

Entire F.V. Pre-Cleaner	--- Replacement ---		Inlet (ID/OD)				--- C ---		--- D ---		--- E ---		Weight		Max. Airflow CFM
	Cover	Bowl	A in	A mm	B in	B mm	C in	C mm	D in	D mm	E in	E mm	lbs	kg	
H002042	P020116	P020115	1.75	44	5.59	142	4.75	121	1.72	44	5.50	140	0.8	0.37	80
H002040	P020116	P020115	2.00	51	5.59	142	4.75	121	1.72	44	5.50	140	0.9	0.41	90
H001823 <sup>1</sup>	P020648	P020227	2.00	51	7.34	186	6.19	157	1.72	44	7.25	184	1.4	0.64	110
H001250	P020648	P020227	2.25	57	7.34	186	6.19	157	1.72	44	7.25	184	1.5	0.68	130
H001251	P020648	P020227	2.50	64	7.34	186	6.19	157	1.72	44	7.25	184	1.5	0.68	150
H001249	P020648	P020227	3.00	76	7.34	186	6.19	157	1.72	44	7.25	184	1.6	0.73	170
H000820 <sup>1</sup>	P016548	P016330	3.00	76	10.63	270	7.66	195	1.84	47	10.50	267	3.4	1.54	320
H000821	P016548	P016330	3.75	95	10.63	270	7.66	195	1.84	47	10.50	267	3.4	1.54	330
H000858	P016548	P016330	4.00	102	10.63	270	7.66	195	1.84	47	10.50	267	3.4	1.54	340
H002045 <sup>1</sup>	P020345	P020344	4.00	103	12.06	306	8.19	208	2.00	51	11.94	303	4.5	2.04	660
H000823	P016548	P016330	4.50	114	10.63	270	7.66	195	1.84	47	10.50	267	3.4	1.54	340
H002044 <sup>1</sup>	P020345	P020344	4.50	114	12.06	306	8.19	208	2.00	51	11.94	303	4.5	2.04	700
H002043	P020345	P020344	5.00	127	12.06	306	7.69	195	2.00	51	11.94	303	4.5	2.04	740
H002223	P104691	P158324	6.00	152	16.25	413	10.00	254	2.81	71	15.94	405	9.2	4.17	1300
H002224	P104691	P158324	7.00	178	16.25	413	10.00	254	2.81	71	15.94	405	9.2	4.17	1500

<sup>1</sup> - Heavy Duty Option



## Extends Filter Life in Extremely Heavy Dust Conditions

The Donaspin™ Pre-Cleaner extends the life your air filter by removing up to 90% of the dirt and contaminant before it reaches the filter and ejecting it automatically via the exhaust system.

Donaspin is designed especially for equipment operating in very heavy dust/debris environments.



### Application

- Vehicles: agricultural equipment, construction and waste haul vehicles
- For engine airflows of 305 to 800 cfm
- Recommended mounting: on top of the air inlet stack

### Features

- Built-in louvers spin air to separate up to 90% of incoming dirt and debris from the air intake system
- Works as part of a scavenged flow system to continuously expel pre-cleaned contaminants through the exhaust flow
- Durable, corrosion-resistant steel construction
- High efficiency with low restriction
- No maintenance. Self-cleaning. No moving parts.
- Mounting clamp is included

### How It Works

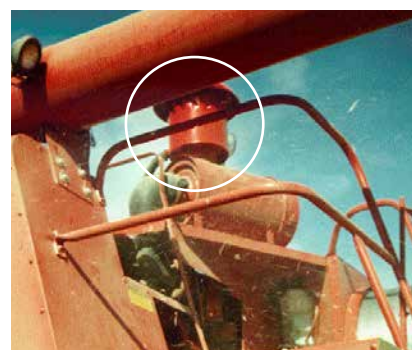
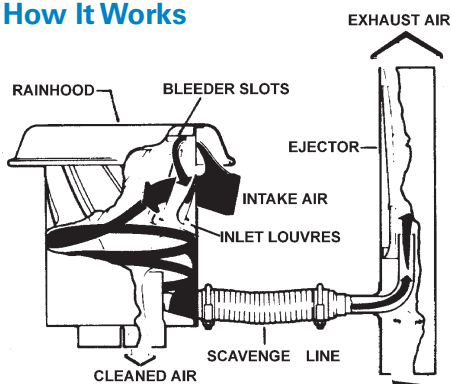

To create a scavenged flow system, combine the Donaspin with a Donaldson exhaust ejector and ejector check valve.

The Donaspin installed on this combine removes most of the incoming dirt, then directs the contaminant out of the system with the exhaust gases.

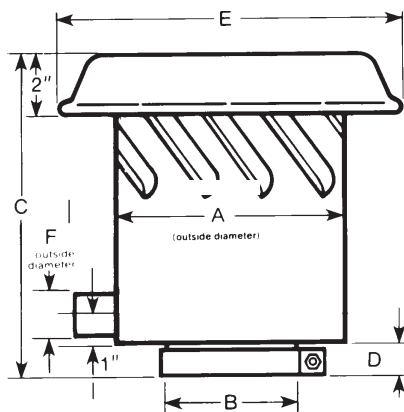

### Donaspin™ Pre-Cleaner

Part Number	A		B (I.D.)		C		D		E		F		Rated Airflow @ 5" H <sub>2</sub> O Added	Approx. Weight	
	in	mm	in	mm	in	mm	in	mm	in	mm	in	mm		lbs	kgs
H001212	8.00	203	3.00	76	11.98	304	2.15	55	12.00	305	1.25	32	305	8	3.6
H001215	8.00	203	4.50	114	10.93	278	1.10	28	12.00	305	1.25	32	465	8	3.6
H001308	8.00	203	5.00	127	11.14	283	1.31	33	12.00	305	1.25	32	530	8	3.6
H001375	9.00	229	6.00	152	14.68	373	1.10	28	13.00	330	1.25	32	770	10	4.5

## Two-stage Cleaning for Unexpected Dust/Moisture Conditions

When your truck is being used in heavier-than-anticipated dust or moisture conditions, you may not have to replace the entire air cleaner. The problem may be solved by adding a Donaldson in-line separator.

Installing this unit on your single-stage system **creates a two-stage air filtration system**. This enables an over-highway vehicle, which usually sees only light dust, to be easily and economically adapted to off-road medium to heavy dust conditions.

### Applications

- **Vertical model:** On/off road, mounted on inlet tubing or cowl mounted directly to air cleaner
  - Compatible with engine airflows of 500 to 1500 cfm
- **Horizontal model:** On/off road, typically mounted underhood
  - Compatible with engine airflows of 100 to 1400 cfm

### Features

- 80% water removal efficiency
- 70% dust removal efficiency

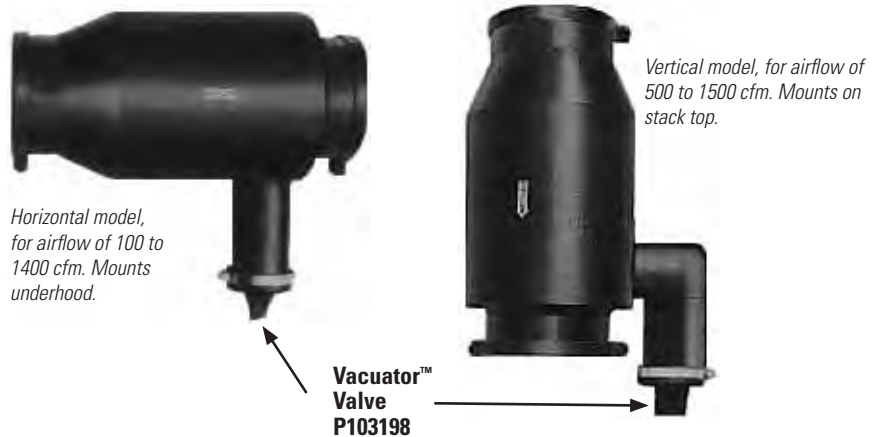

### How It Works

1. When moisture — and/or dust-filled air — enters at one end, the built-in, stationary vanes cause the air to spin.
2. This spin creates centrifugal force, which pushes all moisture and dust to the outside wall where it separates from the air.
3. Moisture and dust are thrown into the Vacuator Valve tubing, then automatically released by the Vacuator Valve.
4. Clean air (acceptable for maximum filter life and engine performance) passes to the air cleaner.

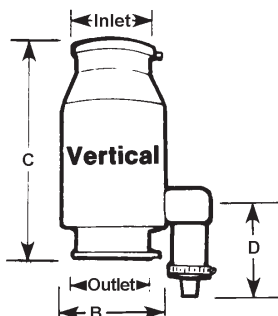
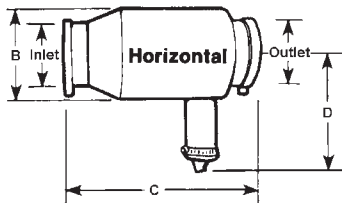
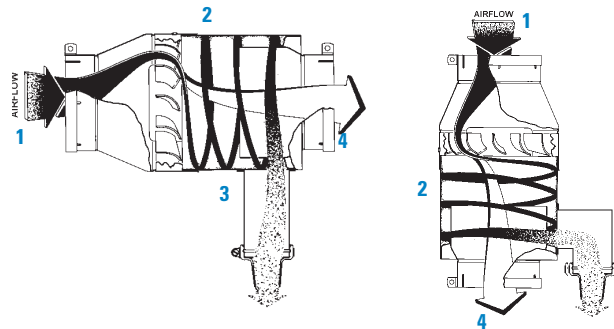

### In-Line Separators

Part Number	CFM Range	Inlet		Outlet		Diameter (B)		Length (C)		D	
		in	mm	in	mm	in	mm	in	mm	in	mm
<b>HORIZONTAL STYLE</b>											
H001474	100-400	4 OD <sup>1</sup>	102 OD	4 OD	102 OD	5.50	140	11.50	292	7.18	182
H000875	500-1,000	6 ID <sup>2</sup>	152 ID	6 ID	152 ID	8.56	217	17.25	438	11.58	294
H001906	700-1,400	7 ID	178 ID	7 ID	178 ID	9.59	244	17.0	432	12.02	305
<b>VERTICAL STYLE</b>											
H000878	500-1,100	6 ID	152 ID	6 ID	152 ID	8.56	217	17.25	438	7.80	198
H000886	750-1,100	7 ID	178 ID	7 ID	178 ID	8.56	217	17.25	438	7.80	198
H001220	900-1,500	8 OD	203 OD	8 ID	203 ID	9.59	244	17.0	432	4.56	115

1 - Outer diameter  
2 - Inner diameter

## Protection Against Rain and Debris Ingestion

- Protects engine air intake from rain, snow, birds, and other large contaminants
- Mounts on stack or directly to air cleaner for on-road and off-road equipment
- Four styles in a wide variety of sizes
- Installs easily with one clamp. Clamp included with hood on styles B, C and D

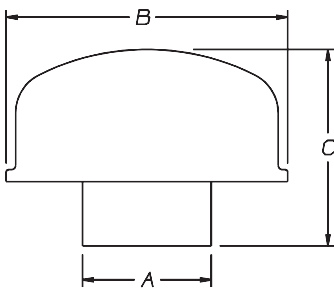

**Inlet Hood — Style A<sup>1</sup>**

Part Number	Fits O.D. (A)		Hood Dia. (B)		Height (C)		Add to Stack		Mat'l	Weight	
	inch	mm	inch	mm	inch	mm	inch	mm		lbs	kgs
X002017	1.75	44	4.13	105	3.31	84	2.75	70	Metal	0.50	0.22
X002018	2.00	51	4.13	105	3.25	83	2.75	70	Metal	0.50	0.22
X002019	2.25	57	5.24	133	3.97	101	3.50	89	Metal	0.80	0.36
X001966	2.50	64	5.25	133	3.97	101	3.50	89	Metal	0.80	0.36
X002014	3.00	76	6.13	156	5.06	129	3.75	95	Metal	1.10	0.50
X001988	3.75	95	8.06	205	7.75	197	6.00	152	Metal	2.10	0.95
X002015	4.00	102	8.06	205	7.88	200	6.00	152	Metal	2.00	0.90

<sup>1</sup> - Clamps must be ordered separately for this style.

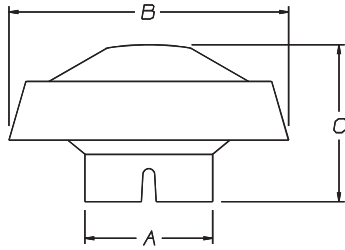

### Inlet Hood — Style B

Part Number	Fits O.D. (A)		Hood Dia. (B)		Height (C)		Add to Stack		Mat'l	Weight	
	inch	mm	inch	mm	inch	mm	inch	mm		lbs	kgs
H002068	1.75	44	6.00	152	3.37	86	2.05	52	Plastic	0.20	0.09
H001377	2.00	51	6.00	152	3.31	84	2.50	64	Plastic	0.20	0.09
H001378	2.50	64	6.00	152	3.31	84	2.50	64	Plastic	0.20	0.09
H001379	3.00	76	6.00	152	3.31	84	2.50	64	Plastic	0.20	0.09

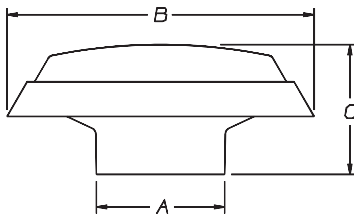

### Inlet Hood — Style C

Part Number	Fits O.D. (A)		Hood Dia. (B)		Height (C)		Add to Stack		Mat'l	Weight	
	inch	mm	inch	mm	inch	mm	inch	mm		lbs	kgs
H001063	3.00	76	11.50	292	5.88	149	3.63	92	Plastic	1.10	0.50
H000466	3.75	95	11.50	292	5.13	130	3.63	92	Plastic	0.80	0.36
H000473 <sup>2</sup>	3.75	95	11.50	292	5.13	130	3.63	92	Plastic	1.00	0.45
H000467	4.00	102	11.50	292	5.06	129	3.38	86	Plastic	0.90	0.40
H000472 <sup>2</sup>	4.00	102	11.50	292	5.06	129	3.38	86	Plastic	1.00	0.45
H000468	4.50	114	11.50	292	4.88	124	3.38	86	Plastic	0.80	0.36
H000471 <sup>2</sup>	4.50	114	11.50	292	4.88	124	3.38	86	Plastic	1.00	0.45
H000469	5.00	127	11.50	292	4.88	124	3.31	84	Plastic	0.80	0.36
H000470 <sup>2</sup>	5.00	127	11.50	292	4.88	124	3.31	84	Plastic	1.00	0.45
H000605 <sup>2</sup>	5.00	127	16.00	407	5.75	146	3.31	104	Plastic	1.80	0.80
H000604 <sup>2</sup>	5.50	140	16.00	407	5.75	146	4.94	125	Plastic	1.80	0.80
H000606 <sup>2</sup>	6.00	152	16.00	407	5.75	146	4.94	125	Plastic	1.80	0.80
H001756	6.00	152	13.00	330	4.06	103	2.69	68	Bright	1.50	0.68
H001948 <sup>2</sup>	6.00	152	16.00	406	5.69	145	4.25	108	Bright	1.50	0.68
H001773	7.00	178	12.81	325	4.81	122	3.44	87	Bright	1.50	0.68
H001742	7.00	178	13.00	330	3.88	99	2.50	64	Bright	1.50	0.68
H000607 <sup>2</sup>	7.00	178	16.00	406	5.75	146	4.09	104	Plastic	1.80	0.80
H001947 <sup>2</sup>	7.00	178	16.00	406	5.69	145	4.25	108	Bright	1.50	0.68
H001053 <sup>2</sup>	8.00	203	16.00	406	6.19	157	4.69	119	Plastic	1.80	0.80
H001946 <sup>2</sup>	8.00	203	16.00	406	6.19	157	4.60	117	Bright	1.50	0.68

Air Inlet Hood Style C offers more models that provide added rain/water protection. While all inlet hoods offer top rain/water there are some that offer additional protection from splash on the underside of the hood.

2 - Hood has rain shroud on underside of hood style.

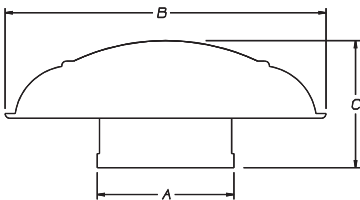

### Inlet Hood — Style D

Part Number	Fits O.D. (A)		Hood Dia. (B)		Height (C)		Add to Stack		Mat'l	Weight	
	inch	mm	inch	mm	inch	mm	inch	mm		lbs	kgs
H000170	4.50	114	9.50	241	4.69	119	3.69	94	Metal	3.20	1.44
H000165	5.00	127	9.50	241	4.69	119	3.69	94	Metal	3.30	1.50
H000275	6.00	152	9.50	241	4.69	119	3.69	94	Metal	3.10	1.40
H000276 <sup>2</sup>	6.00	152	9.50	241	4.69	119	3.69	94	Metal	3.20	1.44
H000339	7.03	179	17.00	432	6.75	171	5.75	146	Metal	4.60	2.08
H770082	10.00	256	15.98	406	7.42	188	5.28	134	Metal	5.0	2.27



## W-Foot Mounting Bands Designed For Donaldson Air Cleaners

- Durable, corrosion-resistant, steel construction
- Fully engineered and tested to resist the adverse effects of vibration
- Mounting band feet are designed to ensure maximum torque pressure, continuously
- Air cleaners require minimum of two mounting bands per housing
- Gauge of steel increases as diameter of mounting band increases
- Bright stainless models available
- Bolt and nut included with mounting band



Most of our air cleaners with metal housings require two mounting bands.

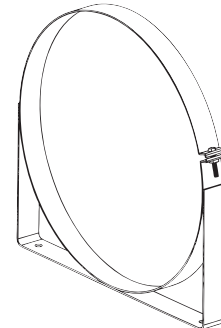

Two models (H770068, H770037) have different foot band compared to others.

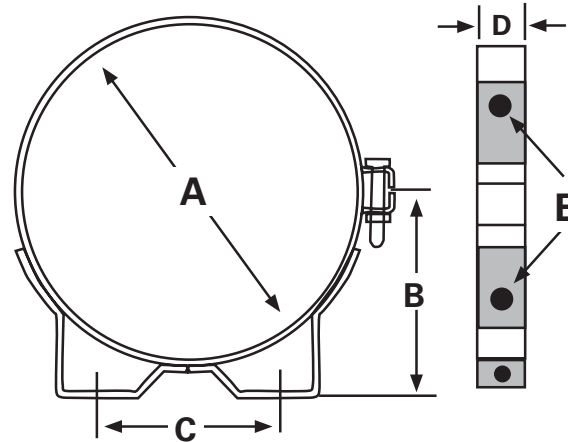

### Air Cleaner Mounting Bands

Part Number	A		B		C		D		E		Weight		Max. Bolt Torque	
	inch	mm	inch	mm	inch	mm	inch	mm	inch	mm	lbs	kg	lbs-ft	N·m
P007189	4.00	102	2.56	65	2.50	64	.75	19	.31	8	0.30	0.14	1.50	2.03
P002348	5.25	133	3.19	81	3.25	83	.88	22	.34	9	0.70	0.32	1.50	2.03
P002351	6.00	152	3.56	90	3.25	83	1.00	25	.34	9	0.80	0.36	1.50	2.03
P007191	6.50	165	3.88	99	3.75	95	.88	22	.41	10	0.70	0.32	2.00	2.71
P004906	7.00	178	4.13	105	4.50	114	.88	22	.30	8	0.80	0.36	3.00	4.07
P003245	7.75	197	4.44	113	4.25	108	1.00	25	.34	9	0.90	0.41	3.50	4.75
P004307	8.00	203	4.50	114	4.25	108	1.00	25	.34	9	1.10	0.50	4.00	5.42
P004073	9.00	229	5.13	130	4.5	114	1.25	32	.45	11	1.50	0.68	4.00	5.42
P004076	10.19	259	5.75	146	5.00	127	1.25	32	.45	11	1.50	0.68	4.00	5.42
P004079	11.00	279	6.13	156	5.00	127	1.25	32	.45	11	1.70	0.77	4.00	5.42
H000349	11.81	300	6.88	175	6.00	152	1.50	38	.41	10	2.50	1.13	4.00	5.42
P013722	13.00	330	7.25	184	6.00	152	1.50	38	.41	10	2.80	1.50	4.00	5.42
P522439*	13.00	330	7.25	184	6.00	152	1.50	38	.41	10	2.80	1.50	4.00	5.42
H000350	14.00	356	8.13	207	8.00	203	1.50	38	.47	12	3.70	1.68	5.00	6.78
P016845	15.00	381	8.00	203	8.00	203	1.50	38	.47	12	4.10	1.86	6.00	8.14
P524552*	15.00	381	8.00	203	8.00	203	1.50	38	.47	12	4.10	1.86	6.00	8.14
H000351	16.00	406	9.13	232	10.00	254	1.50	38	.47	12	4.75	2.16	5.00	6.78
H770037	18.00	457	9.2	234	15.75	400	1.96	50	.55	14	5.25	2.38	5.00	6.78
H770068	21.50	546	10.97	279	19.29	490	1.96	50	.55	14	6.39	2.9	5.00	6.78

\*Bright Stainless Model

## Worm-Drive Hose Clamps

- Versatile clamps for wide size range of hose connections
- Made of strong, durable, noncorrosive stainless steel
- Inside of clamp is lined so that hose doesn't bulge through clamp holes
- Narrow band enables easy installation in confined areas



### Lined Hose Clamp

Part Number	-- Min. to Max. Size -- inch	mm
P532919	9/16 – 13/16	14 – 21
P532920	11/16 – 15/16	17 – 24
P532921	13/16 – 1-1/16	21 – 27
P532923	13/16 – 1-1/2	21 – 38
P532924	13/16 – 1-3/4	21 – 44
P532922	15/16 – 1-1/4	29 – 32
P115200	1-9/16 – 2-1/2	40 – 62
P115201	2-1/16 – 3	52 – 76
P143422	2-13/16 – 3-3/4	71 – 95
P115202	3-5/16 – 4-1/4	84 – 108
P115203	4-5/16 – 5-1/4	109 – 133

### Recommended application up to 40 in·lb torque

Donaldson lined hose clamps seal silicone and other soft hoses without damage. The inner liner extends under the perforations to protect the hose and prevents extrusions through the worm-gear perforations.

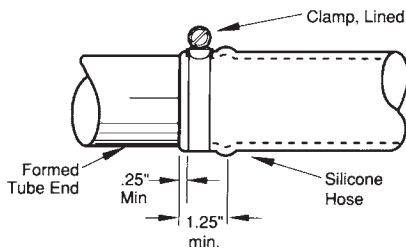

Initial torque on lined hose clamp should be 40 in·lb. If retorquing is required, limit to 20 in·lb.



### Constant Torque Clamp

Part Number	-- Min. to Max. Size -- inch	mm
P532925	2-1/4 – 3-1/8	57 – 79
P532926	2-3/4 – 3-5/8	70 – 92
P532927	3-1/4 – 4-1/8	83 – 105
P532928	3-3/4 – 4-5/8	95 – 117
P532929	4-1/4 – 5-1/8	108 – 130

### Recommended application up to 90 in·lb torque

Donaldson constant torque lined clamps are the best choice for systems where clamps cannot be retightened and have difficult access. Perfect for applications requiring higher torque, large diameters, temperature extremes, or where expansions and contractions within the system are common. This clamp is a good choice for critical coolant and charge-air connections.



### High Torque Clamp

Part Number	-- Min. to Max. Size -- inch	mm
P636718	1-1/4 – 2-1/8	32 – 54
P636719	2-1/4 – 3-1/8	57 – 79
P544076	3-1/4 – 4-1/8	82 – 105
P115204	4-1/4 – 5-1/8	108 – 130
P115205	5-1/4 – 6-1/8	133 – 156
P115206	6-1/4 – 7-1/8	159 – 181
P115207	7-1/4 – 8-1/8	184 – 206
P115208	8-1/4 – 9-1/8	210 – 232
P115209	10-1/4 – 11-1/8	260 – 286

### Recommended application up to 150 in·lb torque

This EXTRA heavy-duty clamp ensures total protection against leakage . . . eliminates the need for double clamping.

## T-Bolt Clamps



Part Number	Nominal I.D. <sup>1</sup>	Min. to Max. Size inch	mm
P148337	2.00	2.25 – 2.53	57 – 64
P148338	2.25	2.50 – 2.78	63 – 70
P148339	2.50	2.81 – 3.09	71 – 78
P148340	2.75	3.06 – 3.34	78 – 85
P148341	3.00	3.31 – 3.59	84 – 91
P148342	3.50	3.81 – 4.09	98 – 104
P148343	4.00	4.31 – 4.59	109 – 116
P148344	4.50	4.81 – 5.09	122 – 129
P148345	5.00	5.31 – 5.59	135 – 142
P148346	5.50	5.94 – 6.21	151 – 158
P148347	6.00	6.38 – 6.65	162 – 169
P148348	7.00	7.38 – 7.78	187 – 198
P148349	8.00	8.25 – 8.56	210 – 217
P629991	8.25	8.50 – 8.81	216 – 224
P148350	10.00	10.50 – 10.91	267 – 277

1 - Nominal I.D. dimension, shown in inches, corresponds to I.D. dimension of rubber part being clamped.

### Recommended application up to 50 in·lb torque

## Filter Service Indicators, Switches, and Sensors Maximize Filter Life

### Trusted Filter Minder® Indicators and Switches — now part of Donaldson!



Replacing filters based on restriction readings can reduce your filter maintenance costs significantly. Visual inspection of air filters is not adequate and should not be used to determine service life. Filters that appear very dirty may still contain a great amount of life.

Over-servicing and excessive handling of filters can result in serious consequences: filter damage, improper installation, intake contamination from ambient dust, and increased service cost, time and material. In contrast, filter service based on restriction readings can help you obtain the longest life possible from the filter, provide the best engine protection, and decrease environmental impact by disposing of fewer filters.

### Restriction Readings: Where & When

Restriction readings are normally taken at the air cleaner on the clean side of the air filter. If the air cleaner does not have a restriction tap, a tap can be added to the system in the ducting between the air cleaner and engine inlet. Check with the engine manufacturer for intake restriction requirements and measurement limits.



Filter service indicators are very effective when mounted *on the outlet tube of the air cleaner* (see The Informer™ above). This gives the operator constant and accurate visibility of filter life.

## Engine Manufacturers Recommended Restriction Limits

Maximum allowable restriction limits are set by engine manufacturers. If your maximum limit is unknown contact your engine manufacturer. To accurately measure the maximum system restriction, all engines need to be operated at high idle and under full load. This will cause engines that boost airflow by using turbo chargers or superchargers to operate under full boost pressure causing maximum airflow to occur. Actual airflow during use may vary depending on multiple factors, including specific product configuration, external conditions and application.

## Choose Restriction Measurement Tools that Best Fit Your Applications

Donaldson offers a variety of restriction measuring devices that help you get the most from your filters. All measure restriction in inches of water vacuum. They are resistant to vibration, breakage, weather, corrosion, dust, and dirt to assure reliable filter restriction readings.

Restriction measurement tools are available in the following categories: Graduated Indicators, Single Position Indicators, Visual Indicator and Switch, Switch Only, Sensors, and LED Displays.

## Graduated Indicators

Graduated indicators, which can be mounted on the air cleaner or in the dashboard, provide restriction readings in inches of water vacuum. A clear window shows the restriction level and when to change the filter.

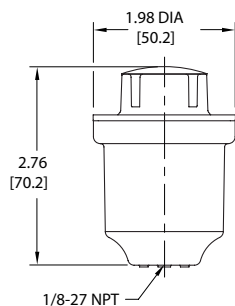

### Filter Minder® Threaded

Part Number	Restriction Limit	Thread Size
135501-00820	20" H <sub>2</sub> O/5 kPa	1/8 NPT
135501-00825	25" H <sub>2</sub> O/6.2 kPa	1/8 NPT
136501-00520	20" H <sub>2</sub> O/5 kPa	3/8-24 UNF
136501-00525	25" H <sub>2</sub> O/6.2 kPa	3/8-24 UNF

This unit continuously monitors air filter restriction. The clear window fills with yellow as filter restriction increases. The indicator locks at several increments. The filter should be changed when the indicator reaches the red zone. Reset the indicator by pushing the yellow reset button.

It can be mounted directly to the air cleaner housing in any orientation. An adaptor fitting is available, if required. Operating temperature: -40 °F to +250 °F (-40 °C to +121 °C).



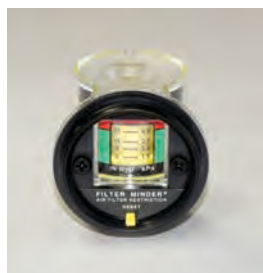

## Filter Minder® Dash Mount

Part Number	Restriction Limit
168501-00220	20" H <sub>2</sub> O/5 kPa
168501-00225	25" H <sub>2</sub> O/6.2 kPa

This unit continuously monitors air filter restriction. It can be mounted in the panel or dash for convenience of the driver or operator. Illuminated version is available. Bezels in chrome, black, or green. Air cleaner fittings and vacuum hose are available for order, separately. Operating temperature: -40 °F to +250 °F (-40 °C to +121 °C)

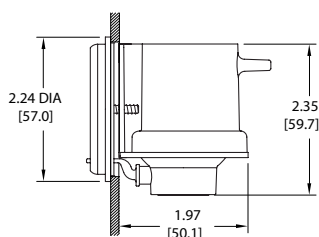

## Service Gauge Dash Mount

Part Number	Restriction Limit	Kit Contents
X002730	30" H <sub>2</sub> O/7.5 kPa	nuts, mounting bracket, and installation instructions
X002700	60" H <sub>2</sub> O/15 kPa	restriction tap fitting (P112257), nuts, mounting bracket, and installation instructions



This unit reads restriction while the engine is running. It installs on an instrument panel or wherever operator can easily see the dial. Mounts into a 2-5/8" diameter hole. Hoses are available for order, separately.

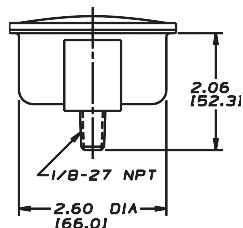

## The Informer™

Part Number	Restriction Limit	Kit (gauge and fitting)
X002278	20" H <sub>2</sub> O/5 kPa	X002103
X002277	25" H <sub>2</sub> O/6.2 kPa	X002102
X002275	30" H <sub>2</sub> O/7.5 kPa	X002101

This unit continuously monitors air filter restriction. A clear window turns red when maximum restriction has been reached. The reset button is on top.

Kit includes full installation instructions and a P100089 safety filter fitting. For remote mounting, order a P105168 flange and a P105622 90° elbow.

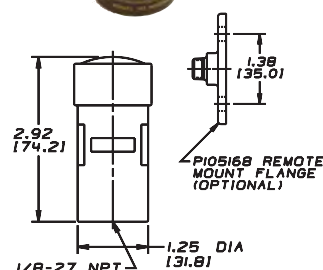

## Single Position Indicators

Single position indicators continuously monitor air filter restriction. Also known as Go/No-Go indicators, these units show whether maximum air filter restriction has or has not been reached. When maximum restriction has been reached, the unit either changes color to red, or displays an orange or red flag, depending on the model.



### Filter Minder®

Part Number	Restriction Limit
175501-00125	25" H <sub>2</sub> O/6.2 kPa
175501-00220	20" H <sub>2</sub> O/5 kPa

The window turns red when the maximum air filter restriction has been reached. Indicator is reset by pushing the yellow button.

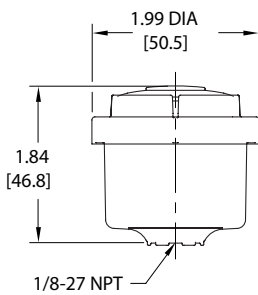

It can be mounted directly to the air cleaner housing in any orientation. An adaptor fitting is available if required. Operating temperature: -40 °F to +250 °F (-40 °C to +121 °C).



### The Mini-Informer

Part Number	Restriction Limit	Gauge and Grommet
X007335	25" H <sub>2</sub> O/6.2 kPa	X007276

The Mini-Informer restriction gauge is designed to mount in the plastic air cleaners of passenger cars, light trucks, and sport utility vehicles.

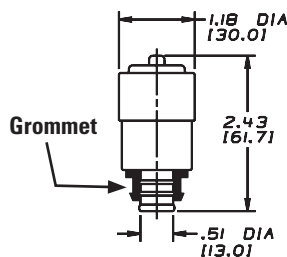

Through the clear window, a green flag shows when air filter restriction is below the service point. When the restriction reaches its limits, an orange flag imprinted with "Change Filter" pops up. The reset button is on top.

The Mini-Informer mounts in the air cleaner ducting in a rubber grommet.



## Servi-Signal™ Mini Indicator

Part Number	Restriction Limit	Kit (gauge and fitting)
X002250	15" H <sub>2</sub> O/ 3.7 kPa	X002350
X002251	20" H <sub>2</sub> O/ 5 kPa	X002351
X002252	25" H <sub>2</sub> O/ 6.2 kPa	X002352
X002254	30" H <sub>2</sub> O/ 7.5 kPa	X002354

Small enough to fit just about anywhere (only 1.66" high), the Donaldson ServiSignal shows a highly visible, bright red flag in the full-view window when restriction limit is reached. Resets manually via top button after air cleaner service.

Kit includes 1/8" NPT threaded brass fitting for mounting on the air cleaner. For remote mount, also order P105168 flange. Hoses are available for order, separately.

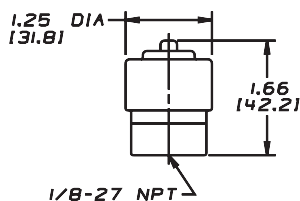

1/8-27 NPT



P105168 REMOTE MOUNT FLANGE (OPTIONAL)



## Visual Restriction Indicator

Part Number	Restriction Limit	Kit (gauge and fitting)
X002215	15" H <sub>2</sub> O/ 3.7 kPa	X002315
X002220	20" H <sub>2</sub> O/ 5 kPa	X002320
X002225	25" H <sub>2</sub> O/ 6.2 kPa	X002325
X002230	30" H <sub>2</sub> O/ 7.5 kPa	X002330

This indicator can be mounted directly on the air cleaner or remotely on the instrument panel or firewall. When restriction limit is reached and filter service is needed, easily-visible, bright red shows through the full-view window. After the filter is serviced, reset via rubber button on top. For remote mount, also order a flange, P105168. Hoses are available for order, separately.

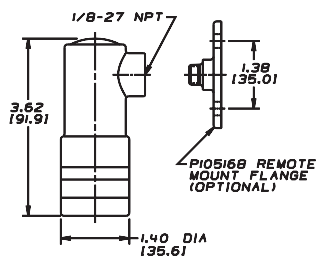

P105168 REMOTE MOUNT FLANGE (OPTIONAL)

## Switches

Air Filter switches continuously monitor air filter restriction. There are two types of switches: Switch Only and Visual Indicator and Switch. Both types send electrical signals to remote “time to service filter” lights, which are usually located in the equipment cab.

### Switch Only

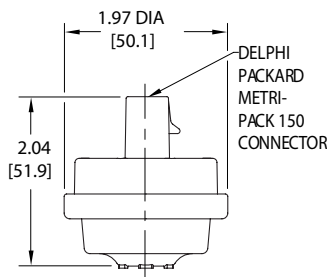

### Filter Minder

Part Number	Restriction Limit	Switch	Thread Size
195389-00120	20" H <sub>2</sub> O/5 kPa	N/O	1/8 NPT
195389-00125	25" H <sub>2</sub> O/6.2 kPa	N/O	1/8 NPT
196398-11120	20" H <sub>2</sub> O/5 kPa	N/C	3/8-24 UNF
196398-11125	25" H <sub>2</sub> O/6.2 kPa	N/C	3/8-24 UNF

These non-locking air switches trigger an air filter warning light via the engine computer or directly to the warning light. They are used for air filter monitoring on diesel, gas, and alternate fuel engines, as well as other applications where low vacuum/pressure monitoring is required.

- Heavy duty, self-cleaning design for heavy-duty service.
- External shield, barrier filter, and labyrinth protects the switch.

It can be mounted directly to the air cleaner housing in any orientation. An adaptor fitting is available, if required. Operating temperature: -40 °F to +250 °F (-40 °C to +121 °C).

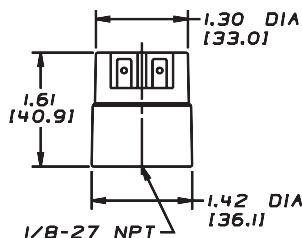

### Electrical Indicator

Part Number	Restriction Limit
X770037	15" H <sub>2</sub> O/ 3.7 kPa
X770050	20" H <sub>2</sub> O/ 5.0 kPa
X770062	25" H <sub>2</sub> O/ 6.2 kPa
X770075	30" H <sub>2</sub> O/ 7.5 kPa

Our electrical indicator is designed for a variety of on- and off-highway applications within operating temperatures of -40 °F to +212 °F (-40 °C to +100 °C). When restriction level reaches the maximum recommended limit, an electrical signal activates a light, a buzzer, or a computer — it's your choice. The indicator automatically resets itself after the filter is serviced.

- 12-24 Volts. Maximum load: 6 watts (light or buzzer)
- Contacts have no polarity
- Switch contacts are normally in the open position
- Quick connectors and light, buzzer, or computer must be purchased separately



## Visual Indicator and Switch

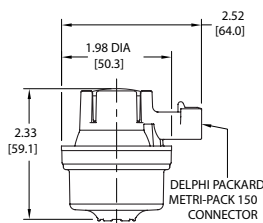

### Filter Minder® Single Position Indicator and Switch

Part Number	Restriction Limit	Switch	Thread Size
175578-10225	25" H <sub>2</sub> O/ 6.2 kPa	N/O	1/8 NPT
175587-13020	20" H <sub>2</sub> O/ 5 kPa	N/C	1/8 NPT

This unit is a combination single position indicator and switch. When the maximum recommended air filter restriction has been reached, the window turns red and a signal is sent to the filter warning light on the dash or engine computer. The warning light locks on until the indicator is reset by pressing the yellow button. It operates in temperatures of -40 °F to +250 °F (-40 °C to +121 °C) and can be mounted in any orientation.

Wire harness adapters are available for order, separately.

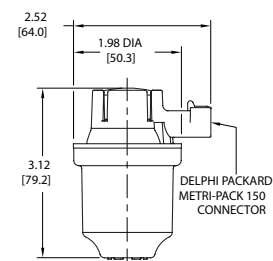

### Filter Minder® Graduated Indicator and Switch

Part Number	Restriction Limit	Switch	Thread Size
135578-08420	20" H <sub>2</sub> O/ 5 kPa	N/O	1/8 NPT
135578-08425	25" H <sub>2</sub> O/ 6.2 kPa	N/O	1/8 NPT
135587-09225	25" H <sub>2</sub> O/ 6.2 kPa	N/C	1/8 NPT
136578-07820	20" H <sub>2</sub> O/ 5 kPa	N/O	3/8-24 UNF
136578-07825	25" H <sub>2</sub> O/ 6.2 kPa	N/O	3/8-24 UNF

This unit is a combination graduated indicator and switch. The yellow indicator moves up in the window and locks at the highest air filter restriction. When it reaches the red zone, or highest recommended restriction, it sends a signal to the filter warning light on the dash or engine computer to record as a diagnostic fault. The warning light locks on until the indicator is reset by pressing the yellow button. It operates in temperatures of -40 °F to +250 °F (-40 °C to +121 °C) and can be mounted in any orientation.

Wire harness adapters are available for order, separately.

## SafetySignal™ Wing Nut Indicator for Safety Filter

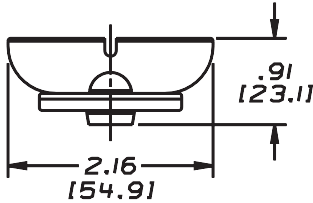

### SafetySignal

Part Number	Air Cleaner	Thread Size	Included Washer
X004814	FTG 13" & 15", FHG12" & 14", FVG16"	7/16" – 20 UNF	P111551
X004815	FTG11	7/16" – 20 UNF	P101872
X004816	FVG14-16", STG12-16" & All SRG models	1/2" – 13 UNC	P105740

The SafetySignal service indicator replaces the wing nut on the metal end cap safety filters and constantly monitors air restriction. When service is required, it locks red and can be reset after service. The SafetySignal requires no special fittings or adapters. Donaldson safety filters are designed to last through multiple primary filter change-outs. The SafetySignal helps save time and money by preventing over-servicing.

## Sensors

Low pressure sensors can monitor vacuum or pressure, and excel at maintaining accuracy across a wide temperature range. They have an integrated AMPSEAL 16 electrical connection, are available in multiple vacuum or pressure settings, and can be furnished with custom mounting. It operates in temperatures of -40 °F to +257 °F (-40 °C to +125 °C )

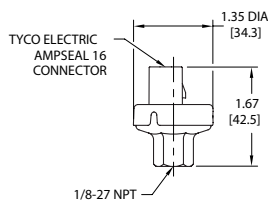

### Filter Minder® Low Pressure Sensor

Part Number	Restriction Limit	Thread Size
115375-00002	2" H <sub>2</sub> O/ 0.5 kPa	1/8 NPT
115305-00005	5" H <sub>2</sub> O/ 1.25 kPa	1/8 NPT
115305-00040	40" H <sub>2</sub> O/ 10 kPa	1/8 NPT

## Restriction Tap Fittings

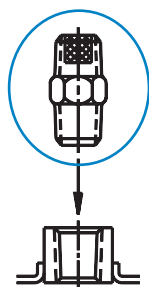

P100089

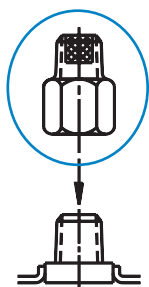

P122067



P633880



P633881

## Restriction Indicator Fitting

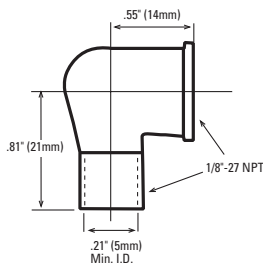

P105622

### Fittings

Part Number	Description
P100089	1/8-27; .44" (11mm) hex nut; Male threads both ends; internal sintered bronze safety filter
P122067	1/8-27; Female threads on one end, male threads on opposite end; internal sintered bronze safety filter
P105622	1/8-27; 90° elbow with threaded end
P633880	1/8-27 NPT x 3/8-24 UNF with Filter and Orifice
P633881	1/8-27 NPT Male to Hose Barb with Filter

## Restriction Tap Sleeve

Install this sleeve in your intake system to convert from scheduled maintenance to more economical restriction maintenance practices.



### Restriction Tap Sleeves

Part Number	Fits Pipe O.D.
P521639	5" / 127mm
P521641	6" / 152mm

## Water Manometer Kit

The Donaldson water manometer kit includes the manometer (flexible tubing), green dye, and full instructions. Manometer, range 18-0-18 in., 17-1/2 oz. mercury.



P134534

Magnets conveniently hold top and bottom ends of manometer to side of equipment or vehicle. Special shut-off valve eliminates the need to empty water after use.

## LED Display

Connect a Filter Minder LED Display to a Filter Minder® sensor to read filter restriction level in the cab.



P633871



P633873

### Filter Minder LED Displays

Part Number	Display Type
P633871	Round
P633872	Round, Sealed
P633873	Square

## Wire Harness Adapters

Wire harness adapters (flying leads) can accommodate most applications.



P633874



P633875

### Filter Minder Wire Harness Adapters

Part Number	Application
P633874	AMP for Low Pressure Sensor
P633875	Packard for Switches

## EPDM Hose

Hose is available in lengths of up to 20 feet.



P633876



P633878

### Filter Minder EPDM Hose

Part Number	Length
P633876	3'
P633877	20'
P633878	10'

## Remote Mount Bracket

The remote mount bracket increases mounting flexibility.



### Filter Minder Remote Mount Bracket

Part Number	Application
P633879	3/8-24 UNF with O-ring



## 90° Rubber Elbows & Reducing/Expanding Elbows



These flexible rubber adapters and elbows have smooth radii and inside surfaces to minimize flow resistance within the air intake system. These rubber products are heavy-duty.

Larger elbows (5"/125mm) are ribbed or compounded for added strength and durability. All Donaldson rubber products meet ASTM standards.

- Resist tears, punctures and vacuum collapse
- Absorb vibration
- Reduce intake noise levels under severe conditions
- Material: EPDM rubber construction
- Temperature range: -40 °F (-40 °C) to +212 °F (+100 °C)
- Do not use after turbo
- Application tip: A minimum 1½" of metal piping should be inserted into the rubber fitting.

### 90° Elbows

Inner Dia. (A) in mm	Center Height (B) in mm	Radius (R) in mm	Part Number
2.00 51	3.50 76	2.00 51	P105529
2.25 57	3.75 95	2.25 57	P105530
2.50 64	4.00 102	2.50 64	P105531
3.00 76	5.25 133	3.75 95	P105532
3.50 89	5.50 140	4.00 102	P114318
4.00 102	5.75 146	4.50 114	P105533
4.50 114	5.50 140	3.50 89	P113733
5.00 127	6.12 155	4.50 114	P107844
5.50 140	6.50 171	4.63 118	P105534
6.00 152	7.00 179	5.00 127	P105535
7.00 179	7.56 192	5.56 141	P105536
8.00 203	8.50 216	6.50 165	P112605
10.00 254	10.50 267	8.50 216	P114314

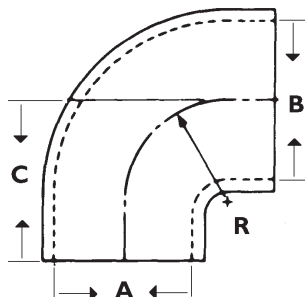
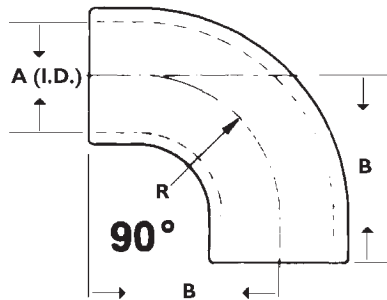

### 90° Elbow Reducers/Expanders

Inner Dia. (A) in mm	Inner Dia. (B) in mm	Center Height (C) in mm	Radius (R) in mm	Part Number
3.00 76	3.50 89	3.50 89	2.25 57	P123462
	4.00 102	4.50 114	3.00 76	P536163
4.00 102	5.00 127	6.00 152	3.75 95	P121482
	6.00 152	4.74 120	3.50 89	P537468
	6.00 152	6.00 152	4.25 108	P143895
5.00 127	7.00 179	6.25 159	4.25 108	P159820
	6.00 152	6.75 171	5.00 127	P117724
	7.00 179	6.25 159	4.38 111	P128990
7.0 179	6.0 152	9.0 229	4.37 111	P215307

## 45° Rubber Elbows, Reducing/Expanding Elbows and Hump Reducers

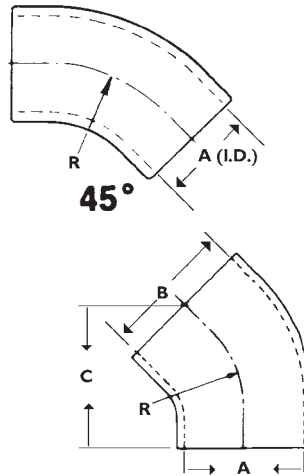

### 45° Elbows

Inner Dia. (A) in	mm	Radius (R) in	mm	Part Number
2.00	51	2.00	51	P105541
2.25	57	2.25	57	P105542
2.50	64	2.50	64	P105543
3.00	76	3.75	95	P105544
3.50	89	3.50	89	P109331
4.00	102	4.25	108	P105545
4.50	114	3.50	89	P114316
5.00	127	4.50	114	P109021
5.50	140	4.75	121	P105546
6.00	152	5.00	127	P105547
7.00	178	5.56	141	P105548
8.00	203	6.50	165	P112606
10.00	254	8.50	216	P114313

### 45° Elbow Reducers/Expanders

Inner Dia. (A) in	mm	Inner Dia. (B) in	mm	Center Height (C) in	mm	Radius (R) in	mm	Part Number
5.50	140	6.00	152	6.44	164	4.88	124	P133338
6.00	152	7.00	179	7.38	187	5.31	135	P133339

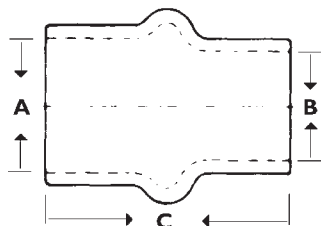

### Rubber Hump Reducers/Expanders

Inner Dia. (A) in	mm	Inner Dia. (B) in	mm	Length (C) in	mm	Part Number
3.00	76	2.50	64	4.50	114	P102820
		2.75	70	3.50	89	P520883
3.50	87	3.00	76	5.00	127	P101290
		2.75	70	4.00	102	P520882
4.00	102	2.75	70	4.00	102	P520884
		3.00	76	5.25	133	P101291
		3.50	87	5.25	133	P101292
4.50	114	4.00	102	6.00	152	P540256
5.00	127	4.00	102	6.00	152	P101293
		4.50	114	6.25	159	P604045 <sup>1</sup>
		5.50	140	6.00	152	P101891
6.00	152	5.00	127	6.00	152	P103516
		5.50	140	6.00	152	P101294
7.00	179	5.00	127	7.00	179	P136494
		5.50	140	7.00	179	P126530
		6.00	152	6.00	152	P112610
8.00	203	5.50	140	7.00	179	P129660
		6.00	152	6.00	152	P114315
		7.00	179	6.00	152	P112609
10.00	254	8.00	203	6.00	152	P112607

1 - Use clamp size for nominal 5" (127mm) I.D. each end.

## Rubber Straight Humps, Reducing/Expanders & Cobra Adapters



### Rubber Straight Humps

Inner Dia. (A)		Length (B)		Part Number
in	mm	in	mm	
3.00	76	5.30	135	P105608
3.50	89	5.25	133	P114319
4.00	102	5.25	133	P105609
4.50	114	6.00	152	P114317
5.00	127	6.00	152	P105610
5.50	140	6.00	152	P105611
6.00	152	7.00	179	P105612
7.00	179	7.00	179	P105613
8.00	203	5.00	127	P112608
10.00	254	6.00	152	P111414

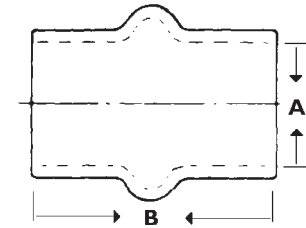

### Rubber Reducers / Expanders

Inner Dia. (A)		Inner Dia. (B)		Length (C)		Part Number
in	mm	in	mm	in	mm	
2.00	51	1.50	38	2.50	64	P104087
		1.75	44			P102948
2.25	57	2.00	51	2.50	64	P104088
2.50	64	2.00	51	2.50	64	P104089
		2.25	57			P104090

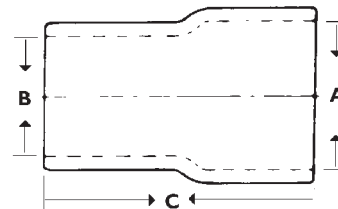

### 90° Cobra Adapters

Inner Dia. (A)		Inner Dia. (C)		Length (B)		(D)		Durometer	Part Number
in	mm	in	mm	in	mm	in	mm		
2.75	70	4.00	102	6.50	165	1.81	46	70	P600328
3.00	76	3.00	76	5.22	133	1.91	49	70	P547694
4.00	102	4.00	102	6.44	164	2.69	68	70	P600325
		4.00	102	6.44	164	2.69	68	80	P626161
4.00	102	4.00	102	6.44	164	3.19	81	70	P600326
		5.00	127	6.44	164	3.19	81	70	P600327

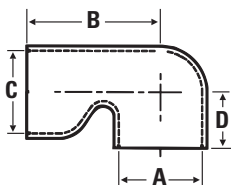

## Silicone Charge Air Connectors Isolate Intake Piping Vibration

### Durable and Easy To Install

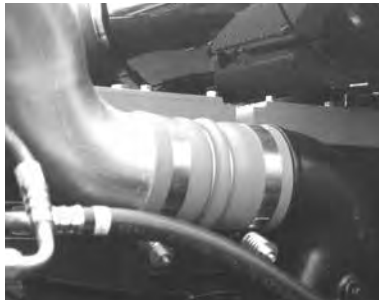

Our three styles of charge air connectors are designed to ease connections in air intake system piping. They compensate for slight misalignment and isolate vibration between hose connections. The silicone elastomer material resists chemicals, steam, ozone, and coolants that are normally found in any engine operating environment.

All three charge air connectors are for installation on the pressure side with maximum operating temperatures up to 500 °F (260 °C). They are orange to be easily identifiable and to signify that they are tolerant of high temperatures. They carry a one-year warranty.



#### Connectors/Sleeves — 50 psi\*

Inner Dia. in	mm	Length in	mm	Part Number
2.00	51	36.00	914	P532948
2.25	57	36.00	914	P532949
2.50	64	36.00	914	P532950
3.00	76	36.00	914	P532951
3.38	86	3.50	89	P532952
		6.00	152	P532953
		36.00	914	P532954
3.50	89	3.50	89	P532956
		4.50	114	P532957
		36.00	914	P532958
4.00	102	36.00	914	P532959

\* working pressure

#### Hump Hose Connectors — 40 psi\*

Inner Dia. in	mm	Length in	mm	Part Number
2.50	66	5.50	140	P532960
2.75	70	4.25	108	P532961
3.00	76	4.38	111	P532962

\* working pressure

#### 4-Ply Bellows — 40 psi\*

Inner Dia. in	mm	Length in	mm	No. of Rings	Part Number
3.50	89	6.00	152	3	P535572
4.00	102	6.00	152	0	P532943
		6.00	152	2	P535571
		6.00	152	3	P532944
		7.50	191	3	P532945
8.00	203	3	3	P535573	

\* working pressure

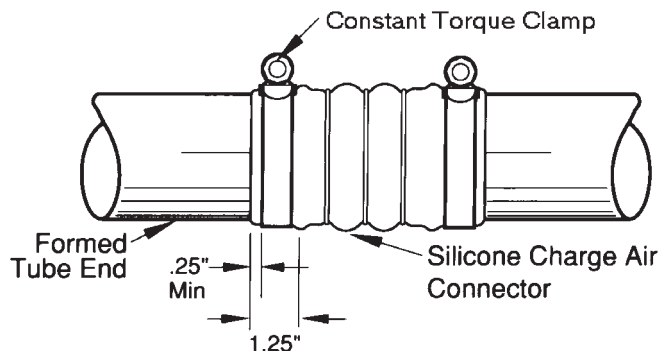

Use the illustration as a guide for installing your charge air connector. For proper installation, use Donaldson Constant Torque clamps to retain clamp load. Torque to 70-75 in·lb.



## Vacuator™ Valves Automatically Expel Dust and Water

The Vacuator Valve, standard on the majority of Donaldson air cleaners, is an important part of the functionality of the air cleaner. It is an integral part of the pre-cleaning stage on two-stage air cleaners.

The dust cup, where pre-cleaned dust is collected, is normally under a slight vacuum when the engine is running. The normal engine pulsing of the vacuum causes the Vacuator Valve to open and close. This action automatically expels any collected dust and water. The Vacuator Valve also unloads when the engine is stopped.

The Donaldson Vacuator Valve, also known as VacValve, is made in a variety of sizes and shapes to fit various applications. The Donaldson part number is molded into each part for easy identification.



*If your air cleaner is equipped with a Donaldson Vacuator™ Valve, make sure your routine filter service includes checking it to make sure it's in good condition and not plugged. If the Vacuator Valve is plugged, clean it.*

### For the longest filter service life, replace damaged or missing Vacuator Valves immediately!

*If your valve is cracked, torn, remains open, or is missing, dust particles that are normally expelled can deposit themselves onto the filter and will shorten air filter service life. Replace it!*

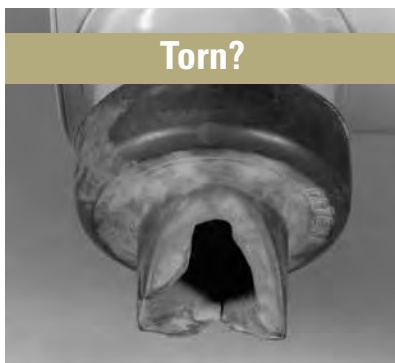
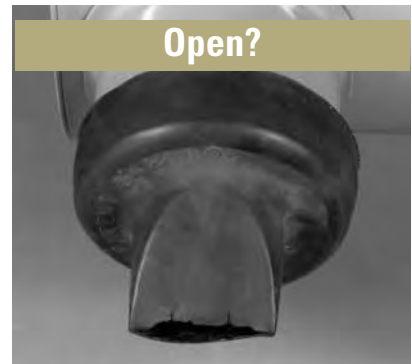



The Donaldson Vacuator™ Valve can be found on the majority of Donaldson air cleaners.

## Application Notes

For proper operation, the Vacuator Valve should be located at the lowest point on the air cleaner or dust cup pointing down.

Never paint the Vacuator Valve. Solvents and chemicals will shorten the usable life.

If the Vacuator Valve is torn, shredded or turned inside out, its durometer may be too soft for the application. Choose a model with a harder durometer (higher number). Conversely, if the Vacuator Valve doesn't empty itself properly, the durometer may be too hard. Choose one with a softer durometer (lower number.)



## Vacuator™ Valves

Part Number	Diameter in	mm	Durometer	Used on Air Cleaner Styles
P103198	3.0	76	40	FRG 10", 12", 14" and 16"; FHG 10", 12", 14" and 16"; FTG; FWA 5" – 16"; FWG 4" – 16"; SRG; In-line Water Separators
P105220	3.0	76	60	FRG 18"; FHG 8"; FVG160587
P106593	3.0	76	60	FHG 6" – 8"; High Pulsation Models
P112803	3.0	76	40	FHG 6" – 8"; PSD 10", PSD 12"; SBG 14" – 16"; SDG; STG 12" – 16"
P149099	1.0	25	60	ERA; EBA; EBB; ECG
P158914	2.0	51	50	XRB, FKB; PSD 8"; PSD 9"; FPG 6" and 8"; FRG 5" – 9", 11"; FHG 5"; FWG; FWA; Moisture Skimmers
P522958	2.0	51	60	FPG 4" – 5"; FHG
P525956	1.0	25	60	EPG 11", 13", 15"
P617632	1.57	40	50	PSD 08"
P776008	2.0	51	60	FPG 9", 10" Twist-off cover; FRG 10", 13", and 15"

# Dust Dumpa Tube Extension For PSD, SRG, STG & SSG Air Cleaners



## Replacement to Your Existing Dust Cup Assembly



### Application

- Donaldson SRG, SSG, STG and PowerCore® PSD Air Cleaners

### How It Works

When installed on the dust cups on the lower assembly, the rubber connector vibrates during normal vehicle operation and gravity expels the pre-cleaned dust.

### Features

- Improves dust evacuation from the air cleaner
- Clear tube allows for visual inspection of dust collection
- Improves safety of the air cleaner inspection process by eliminating the need for ladders or elevated platforms for daily inspections
- Allows operators to perform walk around inspections
- Keeps operators and maintenance personnel away from the nuisance dust normally encountered during air cleaner servicing operations.
- Improves vehicle up-time by minimizing pre/post-shift air cleaner inspections, thus facilitating increased air cleaner service intervals.
- Reduces air cleaner inspection time
- Ships fully assembled
- Proper conversion requires drop down tube for every dust cup



*If the above maintenance practice looks familiar, adding the X006561 Dust Dumpa extension to the dust cups of the air cleaner will save you maintenance time and will minimize your employees exposure to nuisance dust during service.*

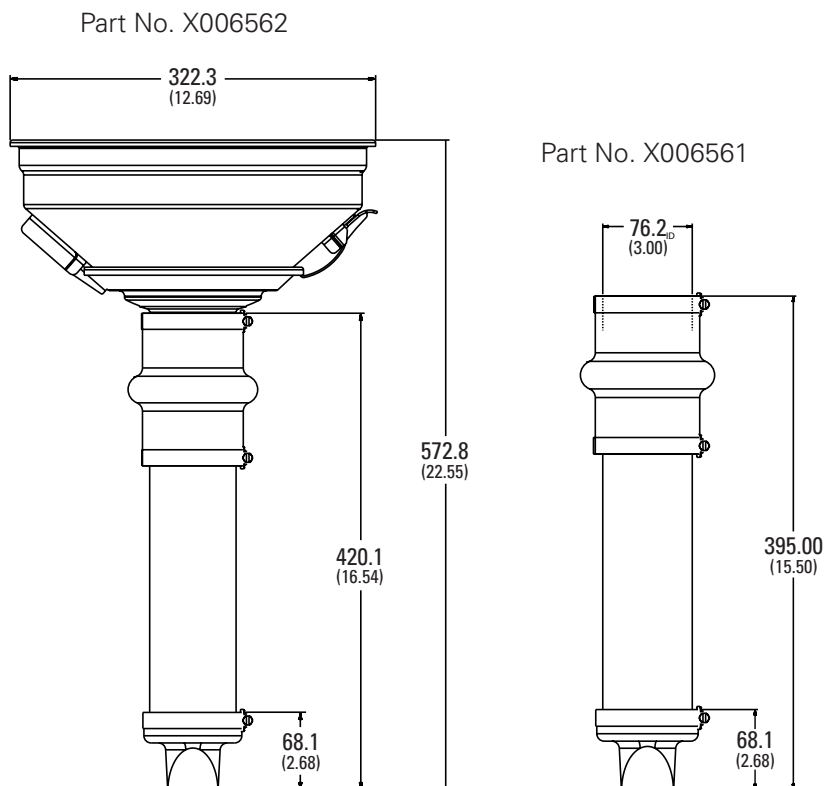



**Available for SRG and SSG Air Cleaners**



Three kits are required for S Series dual outlet models. For proper performance all dust cups must have the new Dust Dumpa installed.

**Dust Dumpa applied to PSD PowerCore® Air Cleaners**



Dust Dumpa + PSD air cleaners extended the filter service life for a geothermal drill rig in Australia.





## Components For Scavenged Air Systems — Exhaust Ejectors and Check Valves

Donaldson exhaust ejectors and check valves are key components to creating a scavenged or aspirated air system. The ejector is used with Donaldson Donaspin™ or Strata™ Cap pre-cleaners, Strata™ systems, or PowerCore® PSD air cleaners.

A scavenged air system is typically used in off-highway equipment to extend air filter life. The exhaust ejector mounts as a stack at the end of exhaust system. It is recommended that the stack be covered with a curved exhaust stack or rain cap.

The redesigned ejector line offers a shorter length tube than our original standard and expanded ID offerings. With less space to work with, the new offering may work in applications where the previous models did not fit.

### ----- Basic Scavenged Air System -----

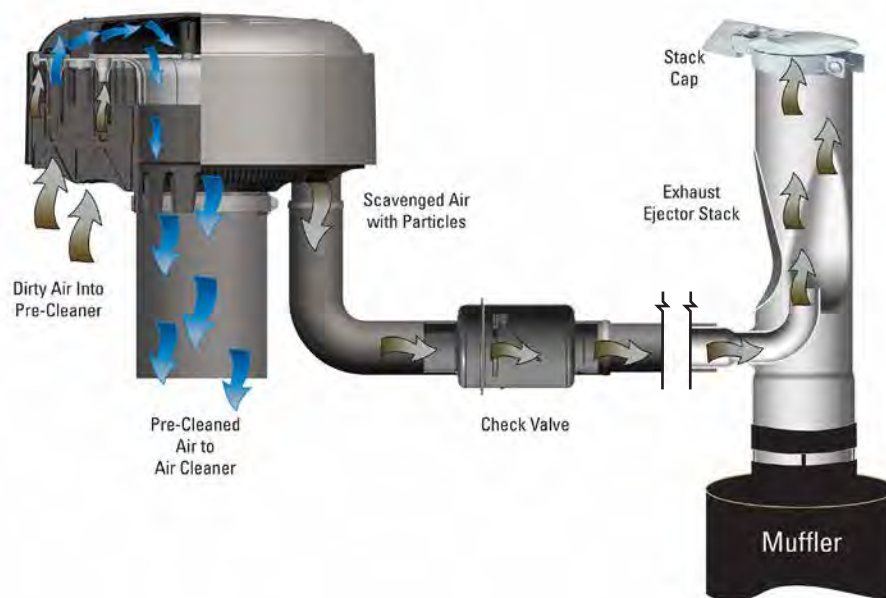

### Exhaust Ejectors

- Can be used with any pre-cleaner that has scavenge tube connection.
- Adds only 4" (102 mm) to 8" (203 mm) H<sub>2</sub>O (.3" to .6" Hg.) to exhaust backpressure
- Models all fit up to a muffler outlet tube outer diameter
- All models have a nominal OD outlet end for proper fit of stack caps and other accessories
- For proper structural support, muffler outlet tube length and stack engagement must be a minimum length of 1.5-2.0" / 38-51 mm
- Finish on all models is high temperature, black, semi-gloss finish

Standard Style



Expanded I.D. End Style



### Interested in Scavenging a PowerCore® Air Cleaner?

See PowerCore Section for specific components and parts.

## Exhaust Ejectors for Scavenged or Aspirated Air System

All exhaust ejectors are constructed of heavy-gauge, aluminized steel, and painted with a high-temperature black paint. Select the appropriate ejector by the intake airflow or exhaust flow (CFM) of your engine.

Engine Intake CFM		Exhaust CFM @ 900° F		Standard Ejectors			Expanded I.D. Ejectors			Length		Scavenge Tube O.D.	
Low	High	Low	High	Inlet Dia.* inches	mm	Part Number	Inlet Dia.* inches	mm	Part Number	inches	mm	inches	mm
220	365	554	919	3.02	77.0	H002612	3.16	80.3	H002762	12.00	304.8	1.25	32
315	450	793	1133	4.02	102.0	H002613	4.17	105.9	H002763	18.00	457.2	1.25	32
425	600	1070	1511	4.02	102.0	H002614	4.17	105.9	H002764	18.00	457.2	1.50	38
500	740	1259	1864	5.03	127.8	H002615	5.17	131.0	H002765	22.00	558.8	1.50	38
660	950	1662	2393	5.03	127.8	H002616	5.17	131.0	H002766	22.00	558.8	1.75	44
800	1150	2015	2896	6.04	153.4	H002617	6.19	157.0	H002767	24.00	609.6	2.00	51
950	1350	2393	3400	6.04	153.4	H002618	6.19	157.0	H002768	24.00	609.6	2.00	51
1100	1500	2770	3778	6.04	153.4	H002619	6.19	157.0	H002769	24.00	609.6	2.00	51

\* This dimension only applies to 2.5" / 64mm of length – not the full length of the ejector.

### 3 ft. / .91 m Silicone Scavenge Hose & Lined Hose Clamp for:

- 1.25" / 32 mm Scavenge Tube: Hose: P171376 and Lined Hose Clamp P532924
- 1.50" / 38 mm Scavenge Tube: Hose: P171378 and Lined Hose Clamp P115200
- 2.00" / 51 mm Scavenge Tube: Hose: P171381 and Lined Hose Clamp P115200

## Ejector Check Valve Prevents Exhaust Backflow

The exhaust ejector check valve prevents backflow of damaging exhaust gases by way of an internal hinge flap. Add an ejector check valve when configuring the intake system to expel filtered contaminant through the exhaust system.

- Mounts horizontally (see installation diagrams)
- Durable, non-corrosive metal construction
- No servicing required

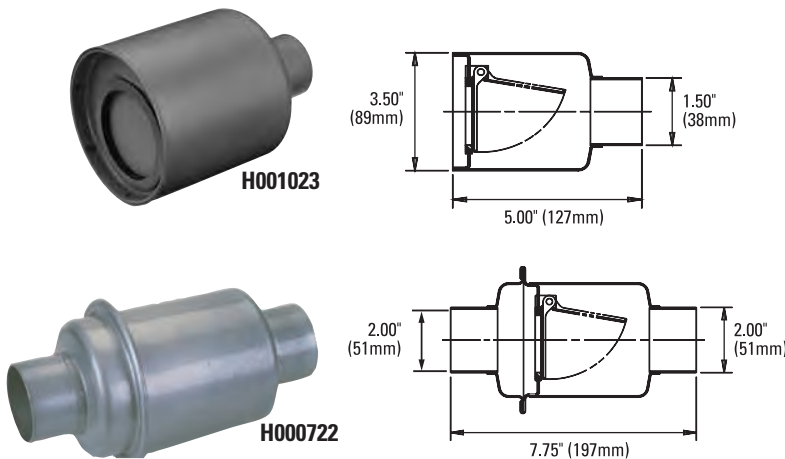

### Check Valve Installation

The illustrations are side views of two-stage air cleaners, showing the position of the check valve. A 3" (76mm) inner diameter rubber reducing elbow or hump reducer is required for installation. See pages 206 – 208 for options.

#### Installation on F Series Cyclopac™

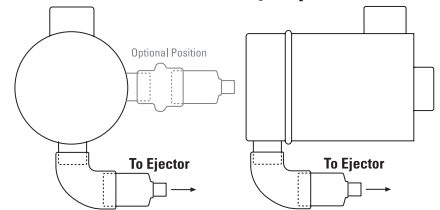

#### Installation on S Series Donaclone™

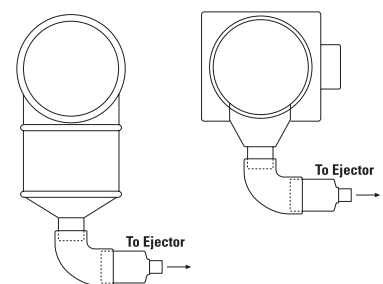

## 3-in-1 Intake Accessory Protects Against Moisture

- Primarily over-highway trucks
- For engine airflow of 700 to 1000+ cfm
- Improves intake system airflow and fuel economy by reducing restriction. Examples:
  - at 33 mph, 53 kmh = 3.5" H<sub>2</sub>O restriction
  - at 45 – 52mph, 72 – 74 kmh = 4" H<sub>2</sub>O restriction
  - at 60 mph, 97 kmh = 5" H<sub>2</sub>O restriction
- Lightweight, non-corrosive, and durable — no service needed
- Inlet screen prevents large debris from entering intake ducting
- Side louvers ensure continuous airflow to intake system
- Common inlet sizes fit most installations
- Eliminates water from air intake system
  - at 700 cfm airflow = 90%
  - at 800 cfm airflow = 93%
  - at 1000 cfm airflow = 93%\*

\* based on item H001660



**H001654**  
High profile model mounts on inlet stack, above and behind cab.



**H001200**  
Low profile model designed for air cleaners mounted on the side of the cab.

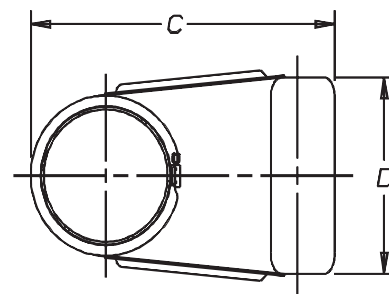
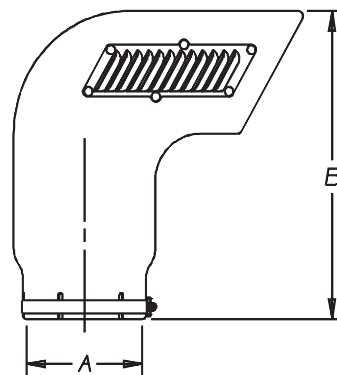

### Air Ram Inlet Hood

Part Number	Inlet Diameter (A)		Height (B)		Depth (C)		Width (D)	
	in	mm	in	mm	in	mm	in	mm
<b>MODELS WITH LOUVERS ON SIDE</b>								
H001660	6.06	154	14.80	376	14.85	377	8.98	228
H001654	7.06	179	15.53	394	15.63	397	9.86	250
H001661	8.06	205	16.16	410	16.95	431	10.92	277
<b>MODELS WITHOUT LOUVERS (LOW PROFILE)</b>								
H001200	7.06	179	6.25	159	12.03	306	13.20	335

Note: One mounting band is included with each Air Ram

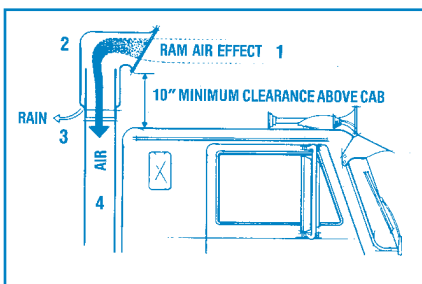

### How Air Ram™ Works

- 1-Moisture-filled air enters Air Ram.
- 2-Air is naturally forced against rear wall. Moisture sticks to the wall, separating from the air.
- 3-Moisture collects on the Air Ram wall and drains down to and out of the drain hole.
- 4-Virtually moisture-free air passes into air cleaner.

### Installation Note

All Air Ram inlet hoods MUST be installed with the screen facing forward to ensure best performance. Airflow restriction will not be reduced if the Air Ram faces sideways; but if it faces backwards, restriction does increase and adversely affects engine performance.

## Horizontal, In-Line Moisture Skimmer Removes Water

### Applications

- Allows 600 to 1200 cfm airflow
- Horizontal mount in engine air intake ducting

### Features

- Removes over 80% of water before it can reach and damage the filter
- No service needed
- Made of durable rubber
- Collected water is automatically released by Vacuator™ Valve
- Adds little or no restriction to airflow
- Common inlet sizes fit most installations



### Mounting Position

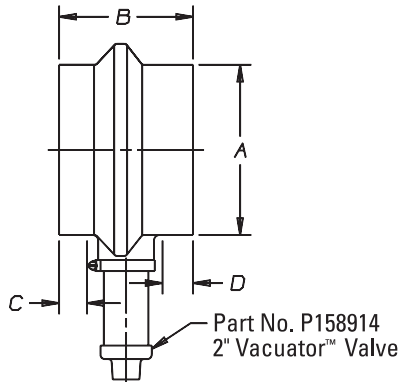
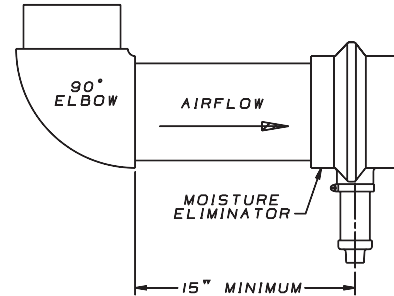

### Moisture Skimmer

Part Number	CFM	Inlet Dia. (A)		Height (B)		Depth (C)		Width (D)	
		in	mm	in	mm	in	mm	in	mm
X005822	600-1000	6.00	152	6.00	152	1.25	32	1.37	35
X005900	800-1200	7.00	178	6.00	152	1.25	32	1.37	35
X005901*	800-1200	7.00	178	6.00	152	1.25	32	1.37	35

\*Angled spout (see image on right)



## Stack-Top Moisture Eliminator Prevents Water Problems

- For cabover trucks, on/off road, mounted on top of an intake stack
- Over 80% water removal efficiency
- Includes clamp for installation



**Part No. X003691**

Airflow Range: 600-1200 cfm

I.D. 7.00" / 178mm

### How It Works

1. Moisture-filled air enters the moisture eliminator cap.
2. Built-in, stationary vanes cause the air to spin.
3. Moisture is forced to the outside wall, where it separates from the air and collects.
4. Water drains out through the drain hole.
5. As a result, drier air (acceptable for maximum filter life and engine performance) passes to the air cleaner.

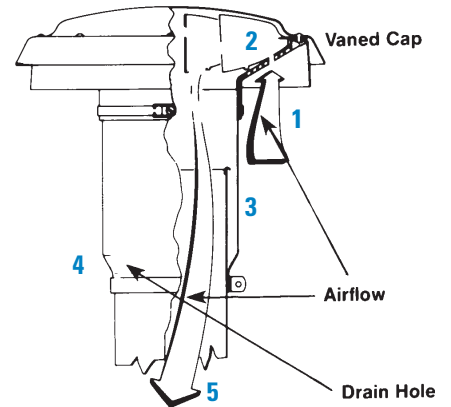



# Stack Extensions, Intake Tubing & Breathers

## Air Stack Extensions

- For on-road and off-road trucks
- Helps extend filter life by elevating air inlet away from heavy dust concentrations and engine exhaust
- Installs easily and quickly with one clamp, which is included with unit
- Durable, corrosion-resistant steel construction

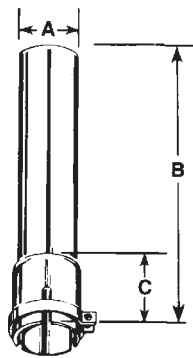

**Air Stack Extension**

-(A - O.D.)-		----(B)----		----(C)----		Part Number
in	mm	in	mm	in	mm	
3.75	95	29.00	737	1.50	38	X001744
4.50	114	30.25	768	1.50	38	X001746
5.00	127	29.00	737	1.50	38	X001747
6.00	152	31.50	800	1.50	38	H000484
7.00	178	28.62	727	1.50	38	H000483

## Intake Tubing

- 16 gauge aluminum, unless footnoted
- 10 ft. (3m) length

**Intake Tubing**

-- O.D. --	Part Number
in mm	
3.00 76	P224684
3.50 89	P224691 <sup>1</sup>
4.00 102	P207367
5.00 127	P206849
5.50 140	P207368
6.00 152	P206850
7.00 178	P206851
8.00 203	P207369

1 - 14 gauge



## Breathers

As sealed machinery operates, its internal air heats and expands; later, this air cools and contracts. To allow hot air out and cool air in **safely**, use a Donaldson breather filter. These handy, spin-on filters use sturdy oil-wetted filter media that resists damage from vibration.

- Designed for engines, air compressors, crankcases, transmissions, gearcases, air cylinders, air presses, hydraulic reservoirs
- Mount either vertically or horizontally
- Can be cleaned and reused

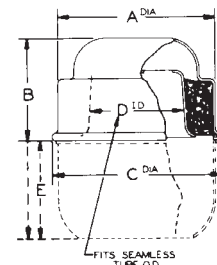
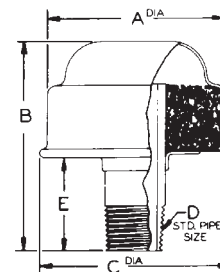

Part Number	--- A ---		--- B ---		--- C ---		--- D ---		--- E ---	
	in	mm	in	mm	in	mm	in	mm	in	mm
<b>STYLE A</b>										
S000011	2.50	64	2.00	51	2.68	68	1/4" NPT	1.00	25	
S000072	2.50	64	2.97	75	2.68	68	1/2" NPT	1.12	28	
S000080	2.50	64	2.32	59	2.68	68	3/4" NPT	0.68	17	
S000183	3.06	78	3.50	89	3.50	89	1" NPT	1.18	30	
S000099	4.06	103	4.50	114	5.12	130	2" NPT	1.68	43	
<b>STYLE B</b>										
S000067	2.50	64	1.62	41	2.75	70	1.50		n/a	

## Section Index

Air Cleaner Service Parts Listing ..... 220  
 Air Cleaner Upgrades ..... 239

The parts in the Service Parts section are listed by air cleaner part number, in alpha/numeric order. If you know the model number of your air cleaner (for instance, G100398), but not the style (e.g., FRG Style B, ERA, or STG), this section will help you find service parts quickly and easily.

AIR CLEANER SERVICE PARTS

### Air Cleaner Service Parts Listing

Part Numbers with \* indicates old/cancelled model (only service parts are available).

Air Cleaner Part No. and Style Description	Service Part No.	Air Cleaner Part No. and Style Description	Service Part No.	Air Cleaner Part No. and Style Description	Service Part No.
*G100161 SBG-TUB		G100395 FRG Style A		G110120 EPG	
Thumb screw.....	P016984	Baffle, metal.....	P602211	Outlet band clamp.....	P148345
Inner cover.....	P101798	Clamp.....	P106071	Thumb screw.....	P527435
Gasket, inner cover.....	P101077	Dust cup/cover.....	P103827	Vacuator™ Valve.....	P525956
Gasket, filter.....	P018182	Elbow, 45°.....	P109021		
Cover gasket.....	P018181	Elbow, 90°.....	P107844	Cover.....	P529151
Gasket, body or cup.....	P101401	Elbow, 90° reducing.....	P143895	Elbow, 45°.....	P109021
Gasket washer.....	P018462	Filter, primary-Donaldson Blue®.....	DBA5222	Elbow, 90°.....	P107844
Filter, primary-extended life.....	P182071	Filter, primary.....	P601790	Elbow, 90° reducing.....	P143895
Filter, primary.....	P181071	Filter, safety.....	P777639	Fastener kit.....	X006452
Cup.....	P018577	Hump hose.....	P105810	Filter, primary-Donaldson Blue®.....	DBA5067
Cover latch assembly.....	P017673	Informer™ indicator 25" H <sub>2</sub> O.....	X002277	Filter, primary - SM.....	P527484
Cover clip spring.....	P017673	Inlet hood, metal.....	H000170	Filter, safety.....	P527680
Cover.....	P018180	Inlet hood, plastic.....	H000468	Hump hose.....	P105610
Clamp, body or cup.....	P101846	Mounting bands, metal.....	P004076	Informer™ indicator 25" H <sub>2</sub> O.....	X002277
Body, upper.....	P101070	O-ring.....	P101401	Outlet band clamp.....	H000604
Body, lower.....	P101086	Outlet band clamp.....	P148345	Thumb screw.....	P527435
		Vacuator™ Valve.....	P103198	Vacuator™ Valve.....	P525956
G100297 FRG Style B		G100398 FRG Style A		G110206 FRG Style B	
Cover.....	P538200	Baffle, metal.....	P602211	Cover.....	P530452
Elbow, 45°.....	P105545	Clamp.....	P106071	Elbow, 45°.....	P114316
Elbow, 90°.....	P105533	Dust cup/cover.....	P103827	Elbow, 90°.....	P113733
Elbow, 90° reducing.....	P121482	Filter, primary-Donaldson Blue®.....	DBA5228	Filter, primary-Donaldson Blue®.....	DBA5105
Filter, primary-Donaldson Blue®.....	DBA5228	Filter, primary.....	P781039	Filter primary - SM.....	P537966
Filter, primary.....	P781039	Filter, safety.....	P777639		
Filter, safety.....	P777639	Gasket, cover.....	P537308		
Gasket, cover.....	P537308				

Air cleaner part numbers that have an "\*" before the number are obsolete, only their service parts listed are available. If an air cleaner replacement is required and the model is no longer available, we recommend retrofitting to a newer air cleaner model. Newer air cleaner models offer improved filtration features, and replacement filters will be less expensive over time.

NOTE: You will not find our one-piece air cleaners, like our Duralite™ disposable series, in this section because they have no service parts.

# Air Cleaner Service Parts Listing

Part Numbers with \* indicates old/cancelled model (only service parts are available).

## Air Cleaner Part No. and Style Description Service Part No.

### \*A042511 FGA

Oil cup .....	P014889
Clamp .....	P002846

### A052526 FWA

Wing nut .....	P101870
Filter, primary-UL approved .....	P122510
Filter, primary-extended life .....	P182050
Filter, primary .....	P181050
Dust cup, VacValve, vert.....	P103835
Cup .....	P103007
Clamp .....	P002904
Baffle, Rubber.....	P102523

### A052527 FWA

Wing nut .....	P101870
Filter, primary-extended life .....	P182050
Dust cup, VacValve, vert.....	P103835
Cup .....	P103007
Clamp .....	P002904
Baffle, Rubber.....	P102523

### \*A060022 FGA

Clamp, cup.....	P002691
-----------------	---------

### A065007 FWA

Wing nut .....	P101870
Filter, primary-extended life .....	P182052
Filter, primary-Donaldson Blue® .....	DBA5134
Dust cup, VacValve, vert.....	P103839
Cup .....	P102805
Clamp .....	P002940
Baffle, Rubber.....	P102510

### A065015 FWA

Wing nut .....	P101870
Filter, primary-extended life .....	P182052
Filter, primary-Donaldson Blue® .....	DBA5134
Dust cup, VacValve, vert.....	P103839
Cup .....	P102805
Clamp .....	P002940
Baffle, Rubber.....	P102510

### A080022 FWA

Wing nut .....	P101870
Filter, primary-high vibration .....	P148968
Filter, primary-extended life .....	P182054
Filter, primary-Donaldson Blue® .....	DBA5054
Filter, primary .....	P181054
Dust cup, VacValve, vert.....	P103840
Cup .....	P103113
Clamp, body or cup .....	P003951
Baffle, Rubber.....	P102980

## Air Cleaner Part No. and Style Description Service Part No.

### \*A080031 FWA

Wing nut .....	P101870
Filter, primary-high vibration .....	P148968
Filter, primary-extended life .....	P182054
Filter, primary-Donaldson Blue® .....	DBA5054
Filter, primary .....	P181054
Dust cup, VacValve, vert.....	P103840
Cup .....	P103113
Clamp, body or cup .....	P003951
Baffle, Rubber.....	P102980

### \*A092018 EBA-KPI

Stud repair kit .....	X004464
Nut, plastic .....	P119325
Mounting band .....	P004073
Cover gasket.....	P150442
Filter, primary treated .....	P129472
Filter, primary reverse flow.....	P140822

### \*A092019 EBA-KPII

Stud repair kit .....	X004464
Nut, plastic .....	P119325
Mounting band .....	P004073
Cover gasket.....	P120597
Filter, primary w/cover gasket .....	P130959

### A092037 EBA KPII

Elbow, 45° .....	P105547
Elbow, 90° .....	P105535
Filter, primary .....	P140822
Filter, primary-Donaldson Blue® .....	DBA5025
Filter, primary treated .....	P129472
Gasket, cover.....	P120597
Hump hose .....	P105612
Informer™ indicator 25" H <sub>2</sub> O .....	X002277
Inlet hood, metal.....	H000275
Inlet hood, plastic.....	H000606
Mounting bands, metal .....	P004073
Nut, plastic .....	P119325
Outlet band clamp.....	P148347
Retaining ring.....	P129469
Vacuator™ Valve .....	P149099

### \*A100013 FGA

Side rod.....	P016731
Screen filter .....	P101390
Inner oil cup.....	P101396

### A100017 FWA

Wing bolt .....	P018464
Gasket, body or cup.....	P101401
Filter, primary-extended life .....	P182045
Filter, primary-Donaldson Blue® .....	DBA5204
Filter, primary .....	P181045
Dust cup, VacValve, vert.....	P103826
Cup.....	P103519
Clamp .....	P106071
Baffle, metal.....	P103135

## Air Cleaner Part No. and Style Description Service Part No.

### A100019 FWA

Wing bolt .....	P018464
Gasket, body or cup.....	P101401
Filter, primary-extended life .....	P182045
Filter, primary-Donaldson Blue® .....	DBA5204
Filter, primary .....	P181045
Dust cup, VacValve, vert.....	P103826
Cup.....	P103519
Clamp .....	P106071
Baffle, metal.....	P103135

### \*A110007 EBA-CYL

Stud repair kit .....	X004464
Nut, plastic .....	P119325
Mounting band .....	P004079
Cover gasket.....	P124141
Filter, primary-extended life .....	P182017
Filter, primary .....	P181146
Filter, primary .....	P181017

### A110052 ERA

Bolt .....	P119463
Cover .....	P544744
Elbow, 45° .....	P105546
Elbow, 90° .....	P105534
Elbow, 90° reducing .....	P128990
Filter, primary-Donaldson Blue® .....	DBA5148
Filter, primary - SM .....	P544741
Gasket, cover.....	P155211
Hump hose .....	P105611
Informer™ indicator 25" H <sub>2</sub> O .....	X002277
Inlet hood, metal.....	H000275
Inlet hood, plastic.....	H000606
Mounting band, black, metal.....	P004079
Nut, plastic .....	P119325
Outlet band clamp.....	P148346
Retaining ring.....	P129469
Vacuator™ Valve .....	P149099

### A112018 EBA KPI

Elbow, 45° .....	P105548
Elbow, 90° .....	P105536
Filter, primary .....	P151097
Filter, primary-Donaldson Blue® .....	DBA5024
Filter, primary treated .....	P129396
Gasket, cover.....	P155211
Hump hose .....	P105613
Informer™ indicator 25" H <sub>2</sub> O .....	X002277
Inlet hood, metal.....	H000339
Inlet hood, plastic.....	H000607
Mounting band, metal .....	P004079
Nut, plastic .....	P119325
Outlet band clamp.....	P148348
Retaining ring.....	P129469
Vacuator™ Valve .....	P149099

## FILTER DESCRIPTIONS:

SM=Scheduled Maintenance Donaldson Blue® = High Efficiency, Extended Service

**Air Cleaner Part No. and Style Description Service Part No.**
**A112078 EBA KPII**

Elbow, 45°	P105548
Elbow, 90°	P105536
Filter, primary	P151097
<b>Filter, primary-Donaldson Blue®</b>	<b>DBA5024</b>
Filter, primary treated	P129396
Gasket, cover	P155211
Hump hose	P105613
Informer™ indicator 25" H <sub>2</sub> O	X002277
Inlet hood, metal	H000339
Inlet hood, plastic	H000607
Mounting bands, metal	P004079
Nut, plastic	P119325
Outlet band clamp	P148348
Retaining ring	P129469
Vacuator™ Valve	P149099

**A120003 FWA**

Wing bolt	P018464
Gasket, body or cup	P017804
Filter, primary-UL approved	P122525
Filter, primary-extended life	P182035
Filter, primary	P181035
Dust cup, VacValve, vert.	P103828
Cup	P101239
Clamp	P100808
Baffle	P101238

**A120036 FWA**

Wing bolt	P018464
Gasket, body or cup	P017804
Filter, primary-UL approved	P122525
Filter, primary-extended life	P182035
Filter, primary	P181035
Dust cup, VacValve, vert.	P103828
Cup	P101239
Clamp	P100808
Baffle	P101238

**\*A127200 FGA**

Side rod	P016731
Screen filter	P016735
Oil cup	P016729
Inner oil cup	P016727
Clip band	P101467

**\*A130045 EBA-CYL**

Stud repair kit	X004464
Nut, plastic	P119325
Mounting band	P013722
Cover gasket	P117800
Filter, primary-extended life	P182007
<b>Filter, primary-Donaldson Blue®</b>	<b>DBA5007</b>
Filter, primary treated	P122708
Filter, primary	P181007

**Air Cleaner Part No. and Style Description Service Part No.**
**\*A130060 EBA-CYL**

Stud repair kit	X004464
Nut, plastic	P119325
Mounting band	P013722
Cover gasket	P117800
Filter, primary-extended life	P182016
<b>Filter, primary-Donaldson Blue®</b>	<b>DBA5016</b>
Filter, primary	P181016

**\*A130087 EBA-CYL**

Stud repair kit	X004464
Nut, plastic	P119325
Mounting band	P013722
Cover gasket	P117800
Filter, primary-extended life	P182016
<b>Filter, primary-Donaldson Blue®</b>	<b>DBA5016</b>
Filter, primary	P181016

**A130115 ERA**

Bolt	P119463
Cover	P542475
Filter, primary - SM	P544950
<b>Filter, primary-Donaldson Blue®</b>	<b>DBA5149</b>
Gasket, cover	P155264
Mounting band, black	P013722
Nut, plastic	P119325
Retaining ring	P129469
Vacuator™ Valve	P149099

**A132001 EBA KPII**

Elbow, 45°	P112606
Elbow, 90°	P112605
Filter, primary	P141228
<b>Filter, primary-Donaldson Blue®</b>	<b>DBA5026</b>
Gasket, cover	P155264
Hump hose	P112608
Informer™ indicator 25" H <sub>2</sub> O	X002277
Inlet hood, plastic	H001053
Mounting bands, metal	P013722
Nut, plastic	P119325
Outlet band clamp	P629991
Retaining ring	P129469
Vacuator™ Valve	P149099

**\*A132004 EBA-KPI**

Stud repair kit	X004464
Nut, plastic	P119325
Mounting band	P013722
Cover gasket	P120604
Filter, primary w/cover gasket	P142100

**\*A132020 EBA-KPII**

Stud repair kit	X004464
Nut, plastic	P119325
Mounting band, bright	P522439
Inlet hood, bright	H001773
Cover gasket	P155264
Filter, primary w/cover gasket	P521598

**Air Cleaner Part No. and Style Description Service Part No.**
**\*A140002 FWA**

Wing bolt	P018464
Gasket, body or cup	P017335
Filter, primary-UL approved	P122529
Filter, primary-extended life	P182000
Filter, primary	P181000
Dust cup, VacValve, vert.	P103829
Cup	P101242
Clamp	P100866
Baffle	P101241

**\*A140003 FWA**

Wing bolt	P018464
Gasket, body or cup	P017335
Filter, primary-UL approved	P122529
Filter, primary-extended life	P182000
Filter, primary	P181000
Dust cup, VacValve, vert.	P103829
Cup	P101242
Clamp	P100866
Baffle	P101241

**\*A140033 FWA**

Wing bolt	P018464
Gasket, body or cup	P017335
Filter, primary-UL approved	P122529
Filter, primary-extended life	P182000
Filter, primary	P181000
Dust cup, VacValve, vert.	P103829
Cup	P101242
Clamp	P100866
Baffle	P101241

**\*A140036 FWA**

Wing bolt	P018464
Gasket, body or cup	P017335
Filter, primary-UL approved	P122529
Filter, primary-extended life	P182000
Filter, primary	P181000
Dust cup, VacValve, vert.	P103829
Cup	P101242
Clamp	P100866
Baffle	P101241

**\*A144800 FGA**

Side rod	P016731
Screen filter	P016688
Oil cup	P016696
Inner oil cup	P016694
Clip band	P101469

**\*A144900 FGA**

Side rod	P016731
Screen filter	P016688
Oil cup	P016696
Inner oil cup	P016694
Clip band	P101469



# Air Cleaner Service Parts Listing

Part Numbers with \* indicates old/cancelled model (only service parts are available).



## Air Cleaner Part No. and Style Description Service Part No.

### \*A145200 FGA

Side rod.....	P016731
Screen filter.....	P016688
Oil cup.....	P016696
Inner oil cup.....	P016694
Clip band.....	P101469

### \*A150039 EBA-CYL

Stud repair kit.....	X004464
Nut, plastic.....	P119325
Mounting band.....	P016845
Cover gasket.....	P116891
Filter, primary-extended life.....	P182008
Filter, primary.....	P181008
Filter, primary-Donaldson Blue®.....	DBA5008

### \*A150128 EBA-CYL

Stud repair kit.....	X004464
Nut, plastic.....	P119325
Mounting band.....	P016845
Cover gasket.....	P116891
Filter, primary-extended life.....	P182009
Filter, primary.....	P181009

### A150138 ERA

Bolt.....	P119463
Cover.....	P544238
Elbow, 45°.....	P105548
Elbow, 90°.....	P105536
Filter, primary-Donaldson Blue®.....	DBA5150
Filter, primary - SM.....	P544301
Gasket, cover.....	P535559
Hump hose.....	P105613
Informer™ indicator 25" H <sub>2</sub> O.....	X002277
Inlet hood, metal.....	H000339
Inlet hood, plastic.....	H000607
Mounting bands, metal.....	P016845
Nut, plastic.....	P119325
Outlet band clamp.....	P148348
Retaining ring.....	P129469
Vacuator™ Valve.....	P149099

### A150141 ERA

Bolt.....	P119463
Cover.....	P544827
Elbow, 45°.....	P105547
Elbow, 90°.....	P105535
Filter, primary-Donaldson Blue®.....	DBA5151
Filter, primary - SM.....	P544243
Gasket, cover.....	P535559
Hump hose.....	P105612
Informer™ indicator 25" H <sub>2</sub> O.....	X002277
Inlet hood, metal.....	H000275
Inlet hood, plastic.....	H000606
Mounting band, black.....	P016845
Mounting bands, metal.....	P016845
Nut, plastic.....	P119325
Outlet band clamp.....	P148347
Retaining ring.....	P129469
Vacuator™ Valve.....	P149099

## Air Cleaner Part No. and Style Description Service Part No.

### \*A150174 EBA-CYL

Stud repair kit.....	X004464
Nut, plastic.....	P119325
Mounting band, bright.....	P524552
Inlet hood, bright.....	P524540
Cover gasket.....	P116891
Filter, primary-extended life.....	P182009
Filter, primary.....	P181009

### A160001 FWA

Wing bolt.....	P018464
Gasket, body or cup.....	P017336
Filter, primary-extended life.....	P182001
Filter, primary.....	P181001
Dust cup, VacValve, vert.....	P103831
Cup.....	P101245
Clamp, cup.....	P100798
Baffle.....	P101244

### \*A160013 FWA

Wing bolt.....	P018464
Gasket, body or cup.....	P017336
Filter, primary-extended life.....	P182001
Filter, primary.....	P181001
Dust cup, VacValve, vert.....	P103831
Cup.....	P101245
Clamp, cup.....	P100798
Baffle.....	P101244

### \*A160173 EBA-CYL

Stud repair kit.....	X004464
Nut, plastic.....	P119325
Mounting band.....	H000351
Cover gasket.....	P123790
Filter, primary-extended life.....	P182011
Filter, primary.....	P181011

### \*A161500 FGA

Side rod.....	P016731
Screen filter.....	P016883
Oil cup.....	P016884
Inner oil cup.....	P016885
Gasket, body or cup.....	P017336
Clip band.....	P101471

### \*A161600 FGA

Side rod.....	P016731
Screen filter.....	P016883
Oil cup.....	P016884
Inner oil cup.....	P016885
Gasket, body or cup.....	P017336
Clip band.....	P101471

## Air Cleaner Part No. and Style Description Service Part No.

### B045008 FKB

Cover.....	P606497
Filter, primary.....	P604457
Filter, safety.....	P603729
Vacuator™ Valve.....	P158914
Elbow, 45°.....	P105541
Elbow, 90°.....	P105529
Informer™ indicator 25" H <sub>2</sub> O.....	X002277
Inlet hood, plastic.....	H001377
Outlet band clamp.....	P148337

### B055006 FKB

Cover.....	P609219
Filter, primary.....	P609218
Filter, safety.....	P602427
Vacuator™ Valve.....	P158914
Elbow, 45°.....	P105543
Elbow, 90°.....	P105531
Informer™ indicator 25" H <sub>2</sub> O.....	X002277
Inlet hood, plastic.....	H001378
Outlet band clamp.....	P148339

### B065045 FKB

Cover.....	P608592
Elbow, 45°.....	P105544
Elbow, 90°.....	P105532
Elbow, 90° reducing.....	P123462
Filter, primary.....	P609221
Filter, safety.....	P608599
Hump hose.....	P105608
Informer™ indicator 25" H <sub>2</sub> O.....	X002277
Inlet hood, plastic.....	H001379
Outlet band clamp.....	P148341
Vacuator™ Valve.....	P158914

### B080080 XRB

Cover.....	P605731
Elbow, 45°.....	P105545
Elbow, 90°.....	P105533
Elbow, 90° reducing.....	P121482
Filter, primary (non metal).....	P611190
Filter, safety.....	P611189
Hump hose.....	P105609
Informer™ indicator 25" H <sub>2</sub> O.....	X002277
Inlet hood, plastic.....	H000467
Outlet band clamp.....	P148343
Vacuator™ Valve.....	P158914

### \*B100001 FWB

Filter, primary.....	P101038
----------------------	---------

### \*B100002 FWB

Filter, primary.....	P101038
----------------------	---------

#### FILTER DESCRIPTIONS:

SM=Scheduled Maintenance Donaldson Blue® = High Efficiency, Extended Service

**Air Cleaner Part No. and Style**  
 Description Service Part No.

**\*B10028 STB**

Pre-cleaner assembly.....	H001001
Mounting band.....	P004076
Hood, pre-cleaner.....	H000657
Filter, safety.....	P124837
Filter, primary.....	P127075
Clamp, pre-cleaner body.....	P007161
Body, Strata Pre-Cleaner.....	H001006
Air Cleaner Assembly, Strata.....	B100029

**B100127 XRB**

Cover.....	P609942
Elbow, 45°.....	P114316
Elbow, 90°.....	P113733
Filter, primary (metal liner).....	P611539
Filter, safety.....	P611540
Hump hose.....	P114317
Informer™ indicator 25" H <sub>2</sub> O.....	X002277
Inlet hood, metal.....	H000165
Inlet hood, plastic.....	H000469
Outlet band clamp.....	P148344
Vacuator™ Valve.....	P158914

**\*B120105 EBB-STYB**

Filter, primary-extended life.....	P182021
Filter, primary.....	P181021

**\*B120129 STB**

Pre-cleaner assembly.....	H001000
Hood, pre-cleaner.....	H000659
Filter, safety.....	P119371
Filter, primary-extended life.....	P182044
Filter, primary.....	P181044
Clamp, pre-cleaner body.....	P004073
Body, Strata Pre-Cleaner.....	H001007
Air Cleaner Assembly, Strata.....	B120131

**B120271 EBB**

Elbow, 45°.....	P109021
Elbow, 90°.....	P107844
Elbow, 90° reducing.....	P143895
Filter, primary.....	P182028
Filter, primary-Donaldson Blue®.....	DBA5028
Filter, primary - SM.....	P181028
Hump hose.....	P105610
Informer™ indicator 25" H <sub>2</sub> O.....	X002277
Inlet hood, plastic.....	H000604
Mounting bands, metal.....	H000349
Outlet band clamp.....	P148345

**B120470 XRB**

Cover.....	P608117
Elbow, 45°.....	P109021
Elbow, 90°.....	P107844
Elbow, 90° reducing.....	P143895
Filter, primary (metal liner).....	P608116
Filter, safety.....	P608391
Hump hose.....	P105610
Informer™ indicator 25" H <sub>2</sub> O.....	X002277
Inlet hood, metal.....	H000275
Inlet hood, plastic.....	H000606
Outlet band clamp.....	P148345
Vacuator™ Valve.....	P158914

**Air Cleaner Part No. and Style**  
 Description Service Part No.

**\*B140019 STB**

Pre-cleaner assembly.....	H001002
Hood, pre-cleaner.....	H000674
Filter, safety.....	P119370
Filter, primary-extended life.....	P182041
Filter, primary.....	P181041
Clamp, pre-cleaner body.....	P127009
Body, Strata Pre-Cleaner.....	H001008
Air Cleaner Assembly, Strata.....	B140020

**B140044 EBB**

Elbow, 45°.....	P105547
Elbow, 90°.....	P105535
Filter, primary.....	P182015
Filter, primary-Donaldson Blue®.....	DBA5015
Filter, primary - SM.....	P181015
Hump hose.....	P105612
Informer™ indicator 25" H <sub>2</sub> O.....	X002277
Inlet hood, metal.....	H000339
Inlet hood, plastic.....	H000607
Mounting bands, metal.....	H000350
Outlet band clamp.....	P148347

**\*B140149 EBB-STYB**

Filter, primary-extended life.....	P182029
Filter, primary.....	P181030

**\*B140150 EBB-STYB**

Filter, primary-extended life.....	P182029
Filter, primary.....	P181030

**B160049 EBB**

Elbow, 45°.....	P105548
Elbow, 90°.....	P105536
Filter, primary.....	P182099
Filter, primary-Donaldson Blue®.....	DBA5099
Filter, primary - SM.....	P181099
Hump hose.....	P105613
Informer™ indicator 25" H <sub>2</sub> O.....	X002277
Inlet hood, plastic.....	H001053
Mounting bands, metal.....	H000351
Outlet band clamp.....	P148348

**B160071 STB**

Clamp, pre-cleaner body.....	P013722
Elbow, 45°.....	P105548
Elbow, 90°.....	P105536
Filter, primary-Donaldson Blue®.....	DBA7039
Filter, primary - ES.....	P182039
Filter, primary - SM.....	P181039
Filter, safety.....	P114931
Gasket washer.....	P105740
Hump hose.....	P105613
Informer™ indicator 25" H <sub>2</sub> O.....	X002277
Outlet band clamp.....	P148348
Pre-cleaner assembly.....	H000672
Pre-cleaner body.....	H001009

**Air Cleaner Part No. and Style**  
 Description Service Part No.

**D080020, D080026 PSD**

Elbow, 45°.....	P109331
Elbow, 90°.....	P114318
Filter, primary.....	P608533
Filter, safety.....	P600975
Hump hose.....	P114319
Informer™ indicator 25" H <sub>2</sub> O.....	X002277
Latch.....	P776033
Outlet band clamp.....	P148342
Vacuator™ Valve.....	P158914

**D080056 PSD**

Cover.....	P615530
Elbow, 45°.....	P109331
Elbow, 90°.....	P114318
Filter, primary.....	P617631
Filter, safety.....	P615493
Hump hose.....	P114319
Informer™ indicator 25" H <sub>2</sub> O.....	X002277
Latch.....	P776033
Outlet band clamp.....	P148342
U-clip (4 clips).....	P784517
Vacuator™ Valve.....	P617632

**\*D090019, D090020 PSD**

Cover.....	P609550
Elbow, 45°.....	P105545
Elbow, 90°.....	P105533
Elbow, 90° reducing.....	P121482
Filter, primary.....	P608665
Filter, safety.....	P606121
Hump hose.....	P105609
Informer™ indicator 25" H <sub>2</sub> O.....	X002277
Latch.....	P777366
Outlet band clamp.....	P148343
U-clip (4 clips).....	P784517
Vacuator™ Valve.....	P158914

**\*D090021, D090022 PSD**

Cover.....	P609552
Elbow, 45°.....	P105545
Elbow, 90°.....	P105533
Elbow, 90° reducing.....	P121482
Filter, primary.....	P608675
Filter, safety.....	P606121
Hump hose.....	P105609
Informer™ indicator 25" H <sub>2</sub> O.....	X002277
Latch.....	P777366
Outlet band clamp.....	P148343
U-clip (4 clips).....	P784517
Vacuator™ Valve.....	P158914

# Air Cleaner Service Parts Listing

Part Numbers with \* indicates old/cancelled model (only service parts are available).



**Air Cleaner Part No. and Style Description Service Part No.**

**D090055, D090073 PSD**

Cover .....	P785651
Elbow, 45° .....	P105545
Elbow, 90° .....	P105533
Elbow, 90° reducing .....	P121482
Filter, primary .....	P608665
Filter, safety .....	P606121
Hump hose .....	P105609
Informer™ indicator 25" H <sub>2</sub> O .....	X002277
Latch .....	P784506
Outlet band clamp .....	P148343
U-clip (4 clips) .....	P784417
Vacuator™ Valve .....	P112803

**D090101 PSD**

Cover .....	P786989
Elbow, 45° .....	P105545
Elbow, 90° .....	P105533
Elbow, 90° reducing .....	P121482
Filter, primary .....	P608675
Filter, safety .....	P606121
Hump hose .....	P105609
Informer™ indicator 25" H <sub>2</sub> O .....	X002277
Latch .....	P777366
Outlet band clamp .....	P148343
U-clip (4 clips) .....	P784517
Vacuator™ Valve .....	P112803

**D090108, D090109 PCD**

Cover .....	P786989 3
Elbow, 45° .....	P105545
Elbow, 90° .....	P105533
Elbow, 90° reducing .....	P121482
Filter, primary .....	P608675
Filter, safety .....	P606121
Hump hose .....	P105609
Informer™ indicator 25" H <sub>2</sub> O .....	X002277
Latch .....	P777366
Outlet band clamp .....	P148343
U-clip (4 clips) .....	P784517

**D090114, D090115 PCD**

Cover .....	P785651
Elbow, 45° .....	P105545
Elbow, 90° .....	P105533
Elbow, 90° reducing .....	P121482
Filter, primary .....	P608665
Filter, safety .....	P606121
Hump hose .....	P105609
Informer™ indicator 25" H <sub>2</sub> O .....	X002277
Latch .....	P777366
Outlet band clamp .....	P148343
U-clip (4 clips) .....	P784517

**D090120 PSD**

Cover .....	P785651
Elbow, 45° .....	P105545
Elbow, 90° .....	P105533
Elbow, 90° reducing .....	P121482
Filter, primary .....	P608665
Filter, safety .....	P606121
Hump hose .....	P105609

**Air Cleaner Part No. and Style Description Service Part No.**

Informer™ indicator 25" H <sub>2</sub> O .....	X002277
Latch .....	P777366
Outlet band clamp .....	P148343
U-clip (4 clips) .....	P784517
Vacuator™ Valve .....	P112803

**D090121 PSD**

Cover .....	P786989
Elbow, 45° .....	P105545
Elbow, 90° .....	P105533
Elbow, 90° reducing .....	P121482
Filter, primary .....	P608675
Filter, safety .....	P606121
Hump hose .....	P105609
Informer™ indicator 25" H <sub>2</sub> O .....	X002277
Latch .....	P777366
Outlet band clamp .....	P148343
U-clip (4 clips) .....	P784517
Vacuator™ Valve .....	P112803

**D100029, D100030 PSD**

Cover .....	P784279
Cover, with watertight seal .....	P619481
Elbow, 45° .....	P109021
Elbow, 90° .....	P107844
Elbow, 90° reducing .....	P143895
Filter, primary .....	P608666
Filter, safety .....	P601560
Hump hose .....	P105610
Informer™ indicator 25" H <sub>2</sub> O .....	X002277
Latch .....	P777366
Outlet band clamp .....	P148345
U-clip (4 clips) .....	P784517
Vacuator™ Valve .....	P112803

**D100031, D100032 PSD**

Cover .....	P784298
Cover, with watertight seal .....	P619482
Elbow, 45° .....	P105547
Elbow, 90° .....	P105535
Filter, primary .....	P608676
Filter, safety .....	P601560
Hump hose .....	P105612
Informer™ indicator 25" H <sub>2</sub> O .....	X002277
Latch .....	P777366
Outlet band clamp .....	P148347
U-clip (4 clips) .....	P784517
Vacuator™ Valve .....	P112803

**D100068 PSD**

Cover .....	P784298
Cover, with watertight seal .....	P619482
Elbow, 45° .....	P105547
Elbow, 90° .....	P105535
Filter, primary .....	P608676
Filter, safety .....	P601560
Hump hose .....	P105612
Informer™ indicator 25" H <sub>2</sub> O .....	X002277
Latch .....	P777366
Outlet band clamp .....	P148347
U-clip (4 clips) .....	P784517
Vacuator™ Valve .....	P112803

**Air Cleaner Part No. and Style Description Service Part No.**

**D100072 PSD**

Cover .....	P784279
Cover, with watertight seal .....	P619481
Elbow, 45° .....	P109021
Elbow, 90° .....	P107844
Elbow, 90° reducing .....	P143895
Filter, primary .....	P608666
Filter, safety .....	P601560
Hump hose .....	P105610
Informer™ indicator 25" H <sub>2</sub> O .....	X002277
Latch .....	P777366
Outlet band clamp .....	P148345
U-clip (4 clips) .....	P784517
Vacuator™ Valve .....	P112803

**D120035, D120036 PSD**

Cover .....	P608171
Elbow, 45° .....	P105547
Elbow, 90° .....	P105535
Filter, primary .....	P608667
Filter, safety .....	P607557
Hump hose .....	P105612
Informer™ indicator 25" H <sub>2</sub> O .....	X002277
Latch .....	P777366
Outlet band clamp .....	P148347
U-clip (4 clips) .....	P784517
Vacuator™ Valve .....	P112803

**D120037, D120038 PSD**

Cover .....	P608180
Elbow, 45° .....	P105547
Elbow, 90° .....	P105535
Filter, primary .....	P608677
Filter, safety .....	P607557
Hump hose .....	P105612
Informer™ indicator 25" H <sub>2</sub> O .....	X002277
Latch .....	P777366
Outlet band clamp .....	P148347
U-clip (4 clips) .....	P784517
Vacuator™ Valve .....	P112803

**\*D140078, D140079 PSD**

Cover, with watertight seal .....	P623026
Elbow, 45° .....	P105548
Elbow, 90° .....	P105536
Elbow, 90° reducing .....	P215307
Filter, primary .....	P621983
Filter, safety .....	P621984
Hump hose .....	P105613
Informer™ indicator 25" H <sub>2</sub> O .....	X002277
Latch .....	P622945
Outlet band clamp .....	P148348
U-clip (9 clips) .....	P622745
Vacuator™ Valve .....	P112803
Gasket .....	P623192

**FILTER DESCRIPTIONS:**

SM=Scheduled Maintenance Donaldson Blue® = High Efficiency, Extended Service

**Air Cleaner Part No. and Style Description Service Part No.**

<b>D140110, D140111</b>	<b>PSD</b>
Cover, with watertight seal.....	P623026
Elbow, 45° .....	P105548
Elbow, 90° .....	P105536
Elbow, 90° reducing .....	P215307
Filter, primary .....	P621983
Filter, safety.....	P621984
Hump hose .....	P105613
Informer™ indicator 25" H <sub>2</sub> O .....	X002277
Latch.....	P629526
Outlet band clamp.....	P148348
U-clip (9 clips).....	P622745
Vacuator™ Valve .....	P112803
Gasket.....	P623192

<b>D100142, D100143</b>	<b>PCD</b>
Cover .....	P784298
Cover, with watertight seal.....	P619482
Elbow, 45° .....	P109021
Elbow, 90° .....	P107844
Filter, primary.....	P608676
Filter, safety.....	P601560
Hump hose .....	P105610
Informer™ indicator 25" H <sub>2</sub> O .....	X002277
Latch.....	P777366
Outlet band clamp.....	P148345
U-clip (4 clips).....	P784517

<b>D100145, D100146</b>	<b>PCD</b>
Cover .....	P784279
Cover, with watertight seal.....	P619481
Elbow, 45° .....	P109021
Elbow, 90° .....	P107844
Elbow, 90° reducing .....	P143895
Filter, primary .....	P608666
Filter, safety.....	P601560
Hump hose .....	P105610
Informer™ indicator 25" H <sub>2</sub> O .....	X002277
Latch.....	P777366
Outlet band clamp.....	P148345
U-clip (4 clips).....	P784517

<b>G042503</b>	<b>FWG</b>
Thumb screw.....	P017858
Gasket washer.....	P102784
Filter, primary-UL approved.....	P123065
Filter, primary-high vibration .....	P148970
Filter, primary .....	P102745
Cup.....	P102755
Clamp .....	P002846

<b>G042529</b>	<b>FWG</b>
Thumb screw.....	P017858
Gasket washer.....	P102784
Cup.....	P102755
Clamp .....	P002846
Baffle, Rubber.....	P102754
Baffle, Rubber.....	P102754

<b>G042544</b>	<b>FPG</b>
Cover .....	P533685
Filter, primary.....	P822686
Filter, safety.....	P535396
Informer™ indicator 25" H <sub>2</sub> O .....	X002277
Inlet hood, plastic.....	H002068

**Air Cleaner Part No. and Style Description Service Part No.**

Latch.....	P538928
Mounting bands, metal .....	H008442
Mounting Bands, plastic.....	P777151
Outlet band clamp.....	P115200
Vacuator™ Valve .....	P522958

<b>G042545</b>	<b>FPG</b>
Cover .....	P533685
Filter, primary.....	P822686
Filter, safety.....	P535396
Informer™ indicator 25" H <sub>2</sub> O .....	X002277
Inlet hood, plastic.....	H002068
Latch.....	P538928
Mounting bands, metal .....	H008442
Mounting Bands, plastic.....	P777151
Outlet band clamp.....	P115200
Vacuator™ Valve .....	P522958

<b>*G042547</b>	<b>FPG</b>
Vacuator™ Valve .....	P522958
Filter, safety.....	P535396
Filter, primary.....	P831520
Latch.....	P538928
Inlet hood (optional).....	H002068
Cover .....	P534392

<b>*G042549</b>	<b>FPG</b>
Vacuator™ Valve .....	P522958
Filter, safety.....	P535396
Filter, primary.....	P831520
Latch.....	P538928
Inlet hood (optional).....	H002068
Cover .....	P534392

<b>G052510</b>	<b>FWG</b>
Wing nut.....	P101870
Filter, primary-UL approved.....	P122510
Filter, primary-extended life .....	P182050
Filter, primary .....	P181050
Dust cup, VacValve, horz .....	P103838
Cup.....	P103007
Clamp .....	P002904
Baffle, Rubber.....	P102523

<b>G052512</b>	<b>FWG</b>
Filter, primary-UL approved.....	P122510
Filter, primary-extended life .....	P182050
Filter, primary .....	P181050
Dust cup, VacValve, horz .....	P103838
Cup.....	P103007
Clamp .....	P002904
Baffle, Rubber.....	P102523

<b>*G052558</b>	<b>FHG-STYA</b>
Wing nut.....	P101870
Vacuator™ Valve .....	P158914
Filter, safety.....	P120307
Filter, primary-high vibration .....	P148967
Filter, primary-extended life .....	P182072
Filter, primary .....	P181072
Cover/cup.....	P120729
Clamp .....	P002904

**Air Cleaner Part No. and Style Description Service Part No.**

<b>*G052559</b>	<b>FHG-STYA</b>
Wing nut .....	P101870
Filter, safety.....	P120307
Filter, primary-high vibration .....	P148967
Filter, primary-extended life .....	P182072
Filter, primary.....	P181072
Cover/cup.....	P120316
Clamp .....	P002904

<b>*G052560</b>	<b>FHG-STYA</b>
Wing nut .....	P101870
Vacuator™ Valve .....	P158914
Filter, safety.....	P120307
Filter, primary-high vibration .....	P148967
Filter, primary-extended life .....	P182072
Filter, primary.....	P181072
Cover/cup.....	P120729
Clamp .....	P002904

<b>*G052561</b>	<b>FHG-STYA</b>
Wing nut .....	P101870
Filter, safety.....	P120307
Filter, primary-high vibration .....	P148967
Filter, primary-extended life .....	P182072
Filter, primary.....	P181072
Cover/cup.....	P120316
Clamp .....	P002904

<b>*G052617</b>	<b>FHG-STYA</b>
Wing nut .....	P101870
Vacuator™ Valve .....	P522958
Filter, safety.....	P120307
Filter, primary.....	P148967
Cover/cup.....	P120729
Clamp .....	P002904

<b>G052685</b>	<b>FRG Style A</b>
Clamp .....	P002904
Cover .....	P120279
Elbow, 45° .....	P105543
Elbow, 90° .....	P105531
Filter, primary.....	P600043
Filter, safety.....	P600047
Informer™ indicator 25" H <sub>2</sub> O .....	X002277
Inlet hood, plastic.....	H001378
Mounting band .....	P002348
Mounting bands, metal .....	P002348
Outlet band clamp.....	P148339
Vacuator™ Valve .....	P158914

<b>G052686</b>	<b>FRG Style A</b>
Clamp .....	P002904
Cover .....	P120279
Elbow, 45° .....	P105543
Elbow, 90° .....	P105531
Filter, primary.....	P600043
Filter, safety (optional).....	P600047
Informer™ indicator 25" H <sub>2</sub> O .....	X002277
Inlet hood, plastic.....	H001378
Mounting band .....	P002348
Mounting bands, metal .....	P002348
Outlet band clamp.....	P148339
Vacuator™ Valve .....	P158914



# Air Cleaner Service Parts Listing

Part Numbers with \* indicates old/cancelled model (only service parts are available).



## Air Cleaner Part No. and Style Description Service Part No.

**G052741, G052742 PowerPleat**

Cover .....	P628588
Filter, primary .....	P628390
Filter, safety .....	P628170
Informer™ indicator 25" H <sub>2</sub> O .....	X002277
Inlet hood, plastic .....	H002068
Mounting bands, metal .....	H008442
Mounting Bands, plastic .....	P777151
Outlet band clamp .....	P115200
Vacuator™ Valve .....	P522958

**G052828, G052829 PowerPleat**

Cover .....	P628588
Filter, primary .....	P628390
Filter, safety .....	P628170
Informer™ indicator 25" H <sub>2</sub> O .....	X002277
Inlet hood, plastic .....	H002068
Mounting bands, metal .....	H008442
Mounting Bands, plastic .....	P777151
Outlet band clamp .....	P115200
Vacuator™ Valve .....	P522958

**G057511 FPG**

Cover .....	P533761
Elbow, 45° .....	P105541
Elbow, 90° .....	P105529
Filter, primary .....	P821575
Filter, safety .....	P822858
Informer™ indicator 25" H <sub>2</sub> O .....	X002277
Inlet hood, plastic .....	H001377
Latch .....	P538928
Mounting bands, metal .....	H008443
Mounting Bands, plastic .....	P777730
Outlet band clamp .....	P148337
Vacuator™ Valve .....	P522958

**G057512 FPG**

Cover .....	P533761
Elbow, 45° .....	P105541
Elbow, 90° .....	P105529
Filter, primary .....	P821575
Filter, safety .....	P822858
Informer™ indicator 25" H <sub>2</sub> O .....	X002277
Inlet hood, plastic .....	H001377
Latch .....	P538928
Mounting bands, metal .....	H008443
Mounting Bands, plastic .....	P777730
Outlet band clamp .....	P148337
Vacuator™ Valve .....	P522958

**G057513 FPG**

Cover .....	P533761
Elbow, 45° .....	P105541
Elbow, 90° .....	P105529
Filter, primary .....	P821575
Filter, safety .....	P822858
Informer™ indicator 25" H <sub>2</sub> O .....	X002277
Inlet hood, plastic .....	H001377
Latch .....	P538928
Mounting bands, metal .....	H008443
Mounting Bands, plastic .....	P777730
Outlet band clamp .....	P148337
Vacuator™ Valve .....	P522958

## Air Cleaner Part No. and Style Description Service Part No.

**G057514 FPG**

Cover .....	P533761
Elbow, 45° .....	P105541
Elbow, 90° .....	P105529
Filter, primary .....	P821575
Filter, safety .....	P822858
Informer™ indicator 25" H <sub>2</sub> O .....	X002277
Inlet hood, plastic .....	H001377
Latch .....	P538928
Mounting bands, metal .....	H008443
Mounting Bands, plastic .....	P777730
Outlet band clamp .....	P148337
Vacuator™ Valve .....	P522958

**\*G057516 FPG**

Vacuator™ Valve .....	P522958
Filter, safety .....	P822858
Filter, primary .....	P831424
Latch .....	P538928
Inlet hood (optional) .....	H001377
Cover .....	P533801

**\*G057517 FPG**

Vacuator™ Valve .....	P522958
Filter, safety .....	P822858
Filter, primary .....	P821424
Latch .....	P538928
Inlet hood (optional) .....	H001377
Cover .....	P533801

**\*G060003 SDG-PER**

Gasket kit .....	X002997
Filter, primary .....	P118342
Cover latch assembly .....	P017617
Cover clip spring .....	P017673
Clamp, cup .....	P002691

**G065008 FWG**

Wing nut .....	P101870
Filter, primary-UL approved .....	P122514
Filter, primary-extended life .....	P182052
Filter, primary-Donaldson Blue® .....	DBA5134
Filter, primary .....	P181052
Dust cup, VacValve, horz .....	P103836
Cup .....	P102805
Clamp .....	P002940
Baffle, Rubber .....	P102510

**G065012 FWG**

Wing nut .....	P101870
Filter, primary-UL approved .....	P122514
Filter, primary-extended life .....	P182052
Filter, primary-Donaldson Blue® .....	DBA5134
Filter, primary .....	P181052
Dust cup, VacValve, horz .....	P103836
Cup .....	P102805
Clamp .....	P002940
Baffle, Rubber .....	P102510

**\*G065104 FHG-STYA**

Wing nut .....	P101870
Filter, safety .....	P119539

## Air Cleaner Part No. and Style Description Service Part No.

Filter, primary-high vibration .....	P148586
Filter, primary-extended life .....	P182062
Filter, primary .....	P181062
Cup .....	P102805
Clamp .....	P002940
Baffle, Rubber .....	P102510

**\*G065113 FHG-STYA**

Wing nut .....	P101870
Filter, safety .....	P119539
Filter, primary-high vibration .....	P148586
Filter, primary-extended life .....	P182062
Filter, primary .....	P181062
Cup .....	P102805
Clamp .....	P002940
Baffle, Rubber .....	P102510

**\*G065212 FHG-STYA**

Wing nut .....	P101870
Vacuator™ Valve .....	P112803
Filter, safety .....	P119539
Filter, primary-high vibration .....	P148586
Filter, primary-extended life .....	P182062
Filter, primary .....	P181062
Dust cup, VacValve, vert .....	P103839
Dust cup, VacValve, horz .....	P103836
Clamp .....	P002940
Baffle, Rubber .....	P102510

**G065256 FHG-STYA**

Wing nut .....	P101870
Vacuator™ Valve .....	P106593
Filter, safety .....	P119539
Filter, primary .....	P148586
Dust cup, VacValve, vert .....	P103839
Dust cup, VacValve, horz .....	P103836
Clamp .....	P002940
Baffle, Rubber .....	P102510

**\*G065261 FHG-STYB**

Wing nut .....	P101870
Vacuator™ Valve .....	P106593
Filter, safety .....	P119539
Filter, primary .....	P148586
Cover .....	P114972

**G065266 FWG**

Wing nut .....	P101870
Filter, primary .....	P148966
Dust cup, VacValve, horz .....	P103836
Cup .....	P102805
Clamp .....	P002940
Baffle, Rubber .....	P102510

**\*G065359 FHG-STYB**

Wing nut .....	P101870
Vacuator™ Valve .....	P112803
Filter, safety .....	P119539
Filter, primary-high vibration .....	P148586
Filter, primary-extended life .....	P182062
Filter, primary .....	P181062
Cover .....	P114972

**FILTER DESCRIPTIONS:**

SM=Scheduled Maintenance Donaldson Blue® = High Efficiency, Extended Service

**Air Cleaner Part No. and Style Description Service Part No.**
**\*G065360 FHG-STYB**

Wing nut.....	P101870
Vacuator™ Valve.....	P112803
Filter, safety.....	P119539
Filter, primary-high vibration.....	P148586
Filter, primary-extended life.....	P182062
Filter, primary.....	P181062

**G065411 FPG**

Cover.....	P539422
Elbow, 45°.....	P105543
Elbow, 90°.....	P105531
Filter, primary.....	P822768
Filter, safety.....	P822769
Informer™ indicator 25" H <sub>2</sub> O.....	X002277
Inlet hood, plastic.....	H001378
Latch.....	P538928
Mounting bands, metal.....	H008441 or H008444
Mounting Bands, plastic.....	P778810
Outlet band clamp.....	P148339
Vacuator™ Valve.....	P158914

**G065424 FPG**

Cover.....	P539422
Elbow, 45°.....	P105543
Elbow, 90°.....	P105531
Filter, primary.....	P822768
Filter, safety.....	P822769
Informer™ indicator 25" H <sub>2</sub> O.....	X002277
Inlet hood, plastic.....	H001378
Latch.....	P538928
Mounting bands, metal.....	H008441 or H008444
Mounting Bands, plastic.....	P778810
Outlet band clamp.....	P148339
Vacuator™ Valve.....	P158914

**\*G065426 FPG**

Vacuator™ Valve.....	P158914
Filter, safety.....	P822769
Filter, primary.....	P532410
Latch.....	P538928
Inlet hood (optional).....	H001378
Cover.....	P532699

**\*G065427 FPG**

Vacuator™ Valve.....	P158914
Filter, safety.....	P822869
Filter, primary.....	P532410
Latch.....	P538928
Inlet hood (optional).....	H001378
Cover.....	P532699

**G065432 FPG**

Cover.....	P539422
Elbow, 45°.....	P105543
Elbow, 90°.....	P105531
Filter, primary.....	P822768
Filter, safety.....	P822769
Informer™ indicator 25" H <sub>2</sub> O.....	X002277

**Air Cleaner Part No. and Style Description Service Part No.**

Inlet hood, plastic.....	H001378
Latch.....	P538928
Mounting bands, metal.....	H008441 or H008444
Mounting Bands, plastic.....	P778810
Outlet band clamp.....	P148339
Vacuator™ Valve.....	P158914

**G065433 FPG**

Cover.....	P539422
Elbow, 45°.....	P105543
Elbow, 90°.....	P105531
Filter, primary.....	P822768
Filter, safety.....	P822769
Informer™ indicator 25" H <sub>2</sub> O.....	X002277
Inlet hood, plastic.....	H001378
Latch.....	P538928
Mounting bands, metal.....	H008441 or H008444
Mounting Bands, plastic.....	P778810
Outlet band clamp.....	P148339
Vacuator™ Valve.....	P158914

**G065541 FRG Style A**

Clamp.....	P002940
Cover.....	P522133
Elbow, 45°.....	P105544
Elbow, 90°.....	P105532
Elbow, 90° reducing.....	P123462
Filter, primary.....	P549271
Filter, safety.....	P549277
Hump hose.....	P105608
Informer™ indicator 25" H <sub>2</sub> O.....	X002277
Inlet hood, plastic.....	H001379
Mounting band.....	P007191
Mounting bands, metal.....	P007191
Outlet band clamp.....	P148341
Vacuator™ Valve.....	P158914

**G065551 FRG Style A**

Clamp.....	P002940
Cover.....	P522133
Elbow, 45°.....	P105544
Elbow, 90°.....	P105532
Elbow, 90° reducing.....	P123462
Filter, primary.....	P549271
Filter, safety (optional).....	P549277
Hump hose.....	P105608
Informer™ indicator 25" H <sub>2</sub> O.....	X002277
Inlet hood, plastic.....	H001379
Mounting band.....	P007191
Mounting bands, metal.....	P007191
Outlet band clamp.....	P148341
Vacuator™ Valve.....	P158914

**G070017 FPG**

Cover.....	P536202
Elbow, 45°.....	P105544
Elbow, 90°.....	P105532
Elbow, 90° reducing.....	P123462
Filter, primary-Donaldson Blue®.....	DBA5225
Filter, primary.....	P827653
Filter, safety.....	P829332

**Air Cleaner Part No. and Style Description Service Part No.**

Hump hose.....	P105608
Informer™ indicator 25" H <sub>2</sub> O.....	X002277
Inlet hood, plastic.....	H001379
Latch.....	P538928
Mounting bands, metal.....	H002070
Mounting Bands, plastic.....	P777731
Outlet band clamp.....	P148341
Vacuator™ Valve.....	P158914

**G070018 FPG**

Cover.....	P536202
Elbow, 45°.....	P105544
Elbow, 90°.....	P105532
Elbow, 90° reducing.....	P123462
Filter, primary-Donaldson Blue®.....	DBA5225
Filter, primary.....	P827653
Filter, safety.....	P829332
Hump hose.....	P105608
Informer™ indicator 25" H <sub>2</sub> O.....	X002277
Inlet hood, plastic.....	H001379
Latch.....	P538928
Mounting bands, metal.....	H002070
Mounting Bands, plastic.....	P777731
Outlet band clamp.....	P148341
Vacuator™ Valve.....	P158914

**G070019 FPG**

Cover.....	P536202
Elbow, 45°.....	P105544
Elbow, 90°.....	P105532
Elbow, 90° reducing.....	P123462
Filter, primary-Donaldson Blue®.....	DBA5225
Filter, primary.....	P827653
Filter, safety.....	P829332
Hump hose.....	P105608
Informer™ indicator 25" H <sub>2</sub> O.....	X002277
Inlet hood, plastic.....	H001379
Latch.....	P538928
Mounting bands, metal.....	H002070
Mounting Bands, plastic.....	P777731
Outlet band clamp.....	P148341
Vacuator™ Valve.....	P158914

**G070020 FPG**

Clamp.....	P003951
Cover.....	P536202
Elbow, 45°.....	P105544
Elbow, 90°.....	P105532
Elbow, 90° reducing.....	P123462
Filter, primary-Donaldson Blue®.....	DBA5225
Filter, primary.....	P827653
Filter, safety.....	P829332
Hump hose.....	P105608
Informer™ indicator 25" H <sub>2</sub> O.....	X002277
Inlet hood, plastic.....	H001379
Latch.....	P538928
Mounting bands, metal.....	H002070
Mounting Bands, plastic.....	P777731
Outlet band clamp.....	P148341
Vacuator™ Valve.....	P158914

# Air Cleaner Service Parts Listing

Part Numbers with \* indicates old/cancelled model (only service parts are available).



## Air Cleaner Part No. and Style Description Service Part No.

### \*G080009 SBG-PER

Vacuator™ Valve .....	P112803
Gasket, filter .....	P018406
Cover gasket .....	P100643
Gasket, body or cup .....	P018293
Gasket kit .....	X002996
Filter, primary-UL approved .....	P122521
Filter, primary-extended life .....	P182068
Filter, primary .....	P181068
Dust cup, VacValve, vert .....	P105010
Dust cup, VacValve, horz .....	P103740
Cup .....	P018298
Cover latch assembly .....	P017617
Cover clip spring .....	P017673
Clamp, body or cup .....	P003951

### \*G080010 SBG-TUB

Gasket, filter .....	P018406
Cover gasket .....	P100643
Gasket, body or cup .....	P018293
Filter, primary-UL approved .....	P122521
Filter, primary-extended life .....	P182068
Filter, primary .....	P181068
Cup .....	P018298
Cover latch assembly .....	P017617
Cover clip spring .....	P017673
Clamp, body or cup .....	P003951

### G080023 FWG

Wing nut .....	P101870
Filter, primary-high vibration .....	P148968
Filter, primary-extended life .....	P182054
Filter, primary-Donaldson Blue® .....	DBA5054
Filter, primary .....	P181054
Dust cup, VacValve, horz .....	P103837
Cup .....	P103113
Clamp, body or cup .....	P003951
Baffle, Rubber .....	P102980

### G080026 FWG

Wing nut .....	P101870
Filter, primary-high vibration .....	P148968
Filter, primary-extended life .....	P182054
Filter, primary-Donaldson Blue® .....	DBA5054
Filter, primary .....	P181054
Dust cup, VacValve, horz .....	P103837
Cup .....	P103113
Clamp, body or cup .....	P003951
Baffle, Rubber .....	P102980

### \*G080147 FHG-STYB

Wing nut .....	P101870
Vacuator™ Valve .....	P105220
Filter, safety .....	P112212
Filter, primary-high vibration .....	P148973
Filter, primary-extended life .....	P182059
Filter, primary-Donaldson Blue® .....	DBA5059
Filter, primary .....	P181059
Cover .....	P119711

## Air Cleaner Part No. and Style Description Service Part No.

### \*G080195 FHG-STYA

Wing nut .....	P101870
Filter, safety .....	P119410
Filter, primary-high vibration .....	P148973
Filter, primary-extended life .....	P182059
Filter, primary-Donaldson Blue® .....	DBA5059
Filter, primary .....	P181059
Cup .....	P103113
Clamp .....	P003951
Baffle, Rubber .....	P102980

### \*G080200 FHG-STYA

Wing nut .....	P101870
Filter, safety .....	P119410
Filter, primary-high vibration .....	P148973
Filter, primary-extended life .....	P182059
Filter, primary-Donaldson Blue® .....	DBA5059
Filter, primary .....	P181059
Cup .....	P103113
Clamp .....	P003951
Baffle, Rubber .....	P102980

### G080372 FHG-STYB

Wing nut .....	P101870
Vacuator™ Valve .....	P106593
Filter, safety .....	P119410
Filter, primary .....	P148573
Cover .....	P119711

### \*G080490 FHG-STYB

Wing nut .....	P101870
Vacuator™ Valve .....	P112803
Filter, safety .....	P119410
Filter, primary-high vibration .....	P148973
Filter, primary-extended life .....	P182059
Filter, primary-Donaldson Blue® .....	DBA5059
Filter, primary .....	P181059
Cover .....	P119711

### \*G080491 FHG-STYB

Wing nut .....	P101870
Vacuator™ Valve .....	P112803
Filter, safety .....	P119410
Filter, primary-high vibration .....	P148973
Filter, primary-extended life .....	P182059
Filter, primary-Donaldson Blue® .....	DBA5059
Filter, primary .....	P181059
Cover .....	P119711

### G080582 FRG Style A

Clamp .....	P003951
Cover .....	P600321
Elbow, 45° .....	P109331
Elbow, 90° .....	P114318
Filter, primary-Donaldson Blue® .....	DBA5223
Filter, primary .....	P601437
Filter, safety .....	P601476
Hump hose .....	P114319
Informer™ indicator 25" H <sub>2</sub> O .....	X002277
Inlet hood, plastic .....	H000466
Mounting band .....	P004307
Mounting bands, metal .....	P004307
Outlet band clamp .....	P148342
Vacuator™ Valve .....	P158914

## Air Cleaner Part No. and Style Description Service Part No.

### G080585 FRG Style A

Cover .....	P600321
Elbow, 45° .....	P109331
Elbow, 90° .....	P114318
Filter, primary-Donaldson Blue® .....	DBA5223
Filter, primary .....	P601437
Filter, safety (optional) .....	P601476
Hump hose .....	P114319
Informer™ indicator 25" H <sub>2</sub> O .....	X002277
Inlet hood, plastic .....	H000466
Mounting band .....	P004307
Mounting bands, metal .....	P004307
Outlet band clamp .....	P148342
Vacuator™ Valve .....	P158914

### G082525 FPG

Cover .....	P534048
Elbow, 45° .....	P109331
Elbow, 90° .....	P114318
Filter, primary-Donaldson Blue® .....	DBA5227
Filter, primary .....	P828889
Filter, safety .....	P829333
Hump hose .....	P114319
Informer™ indicator 25" H <sub>2</sub> O .....	X002277
Inlet hood, plastic .....	H000466
Latch .....	P538928
Mounting bands, metal .....	H002023
Mounting Bands, plastic .....	P777732
Outlet band clamp .....	P148342
Vacuator™ Valve .....	P158914

### G082526 FPG

Cover .....	P534048
Elbow, 45° .....	P109331
Elbow, 90° .....	P114318
Filter, primary-Donaldson Blue® .....	DBA5227
Filter, primary .....	P828889
Filter, safety .....	P829333
Hump hose .....	P114319
Informer™ indicator 25" H <sub>2</sub> O .....	X002277
Inlet hood, plastic .....	H000466
Latch .....	P538928
Mounting bands, metal .....	H002023
Mounting Bands, plastic .....	P777732
Outlet band clamp .....	P148342
Vacuator™ Valve .....	P158914

### G082527 FPG

Cover .....	P534048
Elbow, 45° .....	P109331
Elbow, 90° .....	P114318
Filter, primary-Donaldson Blue® .....	DBA5227
Filter, primary .....	P828889
Filter, safety .....	P829333
Hump hose .....	P114319
Informer™ indicator 25" H <sub>2</sub> O .....	X002277
Inlet hood, plastic .....	H000466
Latch .....	P538928
Mounting bands, metal .....	H002023
Mounting Bands, plastic .....	P777732
Outlet band clamp .....	P148342
Vacuator™ Valve .....	P158914

#### FILTER DESCRIPTIONS:

SM=Scheduled Maintenance Donaldson Blue® = High Efficiency, Extended Service

**Air Cleaner Part No. and Style Description Service Part No.**

**G082528 FPG**

Clamp .....	P102025
Cover .....	P534048
Elbow, 45° .....	P109331
Elbow, 90° .....	P114318
Filter, primary-Donaldson Blue® .....	<b>DBA5227</b>
Filter, primary .....	P828889
Filter, safety .....	P829333
Hump hose .....	P114319
Informer™ indicator 25" H <sub>2</sub> O .....	X002277
Inlet hood, plastic .....	H000466
Latch .....	P538928
Mounting bands, metal .....	H002023
Mounting Bands, plastic .....	P777732
Outlet band clamp .....	P148342
Vacuator™ Valve .....	P158914

**\*G090022 FHG-STYA**

Wing nut .....	P101870
Filter, safety .....	P119778
Filter, primary-extended life .....	P182063
Filter, primary-Donaldson Blue® .....	<b>DBA5234</b>
Filter, primary .....	P181063
Cover/cup .....	P112667
Clamp .....	P102025
Baffle .....	P105050

**\*G090024 FHG-STYA**

Wing nut .....	P101870
Filter, safety .....	P119778
Filter, primary-extended life .....	P182063
Filter, primary-Donaldson Blue® .....	<b>DBA5234</b>
Filter, primary .....	P181063
Cover/cup .....	P112667
Clamp .....	P102025
Baffle .....	P105050

**\*G090182 FHG-STYB**

Wing nut .....	P101870
Filter, safety .....	P119778
Filter, primary-extended life .....	P182063
Filter, primary-Donaldson Blue® .....	<b>DBA5234</b>
Filter, primary .....	P181063
Cover .....	P115466

**\*G090183 FHG-STYB**

Wing nut .....	P101870
Filter, safety .....	P119778
Filter, primary-extended life .....	P182063
Filter, primary-Donaldson Blue® .....	<b>DBA5234</b>
Filter, primary .....	P181063
Cover .....	P115466

**G090219 FPG**

Cover .....	P780524
Elbow, 45° .....	P105545
Elbow, 90° .....	P105533
Elbow, 90° reducing .....	P121482
Filter, primary-Donaldson Blue® .....	<b>DBA5226</b>
Filter, primary .....	P780522

**Air Cleaner Part No. and Style Description Service Part No.**

Filter, safety .....	P780523
Hump hose .....	P105609
Informer™ indicator 25" H <sub>2</sub> O .....	X002277
Inlet hood, metal .....	H000170
Inlet hood, plastic .....	H000468
Mounting Bands, plastic .....	P780532
Outlet band clamp .....	P148343
Vacuator™ Valve .....	H776008

**G090225 FPG**

Cover .....	P780524
Elbow, 45° .....	P105545
Elbow, 90° .....	P105533
Elbow, 90° reducing .....	P121482
Filter, primary-Donaldson Blue® .....	<b>DBA5226</b>
Filter, primary .....	P780522
Filter, safety .....	P780523
Hump hose .....	P105609
Informer™ indicator 25" H <sub>2</sub> O .....	X002277
Inlet hood, metal .....	H000170
Inlet hood, plastic .....	H000468
Mounting Bands, plastic .....	P780532
Outlet band clamp .....	P148343
Vacuator™ Valve .....	H776008

**G090245 FRG Style A**

Clamp .....	P102025
Cover .....	P600657
Elbow, 45° .....	P105545
Elbow, 90° .....	P105533
Elbow, 90° reducing .....	P121482
Filter, primary-Donaldson Blue® .....	<b>DBA5224</b>
Filter, primary .....	P601280
Filter, safety .....	P601286
Hump hose .....	P105609
Informer™ indicator 25" H <sub>2</sub> O .....	X002277
Inlet hood, metal .....	H000170
Inlet hood, plastic .....	H000468
Mounting band .....	P004073
Mounting bands, metal .....	P004073
Outlet band clamp .....	P148343
Vacuator™ Valve .....	P158914

**G090250 FRG Style A**

Cover .....	P600657
Elbow, 45° .....	P105545
Elbow, 90° .....	P105533
Elbow, 90° reducing .....	P121482
Filter, primary-Donaldson Blue® .....	<b>DBA5224</b>
Filter, primary .....	P601280
Filter, safety (optional) .....	P601286
Hump hose .....	P105609
Informer™ indicator 25" H <sub>2</sub> O .....	X002277
Inlet hood, metal .....	H000170
Inlet hood, plastic .....	H000468
Mounting band .....	P004073
Mounting bands, metal .....	P004073
Outlet band clamp .....	P148343
Vacuator™ Valve .....	P158914

**G092001 ECG Bolt Service Cover**

Elbow, 45° .....	P105547
Elbow, 90° .....	P105535
Filter, primary, no cover, treated .....	P148044

**Air Cleaner Part No. and Style Description Service Part No.**

Hump hose .....	P105612
Informer™ indicator 25" H <sub>2</sub> O .....	X002277
Inlet hood, metal .....	H000275
Inlet hood, plastic .....	H000606
Mounting bands, metal .....	P004073
Nut, plastic .....	P119325
Outlet band clamp .....	P148347
Retaining ring .....	P129469

**\*G092004 ECG-KPII**

Stud repair kit .....	X004464
Nut, plastic .....	P119325
Mounting band .....	P004073
Cover gasket .....	P120597
Filter, primary treated .....	P148044

**G092401 ECG Latch Service Cover**

Elbow, 45° .....	P105547
Elbow, 90° .....	P105535
Filter, primary, attached cover .....	P150693
Filter, primary, no cover .....	P150692
Filter, primary, no cover, treated .....	P148044
Hump hose .....	P105612
Informer™ indicator 25" H <sub>2</sub> O .....	X002277
Inlet hood, metal .....	H000275
Inlet hood, plastic .....	H000606
Mounting bands, metal .....	P004073
Outlet band clamp .....	P148347
Spring latch replacement kit .....	X006201

**\*G092501 ECG-KPI**

Latch replacement kit .....	X006201
Filter, primary-extended life .....	P150693
Filter, primary treated .....	P148044
Filter, primary .....	P150692

**G100003 FWG**

Wing bolt .....	P018464
Gasket, body or cup .....	P101401
Filter, primary-extended life .....	P182045
Filter, primary-Donaldson Blue® .....	<b>DBA5204</b>
Filter, primary .....	P181045
Dust cup, VacValve, horz .....	P103827
Cup .....	P103519
Clamp .....	P106071
Baffle, metal .....	P103135

**G100004 FWG**

Wing bolt .....	P018464
Gasket, body or cup .....	P101401
Filter, primary-extended life .....	P182045
Filter, primary-Donaldson Blue® .....	<b>DBA5204</b>
Filter, primary .....	P181045
Dust cup, VacValve, horz .....	P103827
Cup .....	P103519
Clamp .....	P106071
Baffle, metal .....	P103135



# Air Cleaner Service Parts Listing

Part Numbers with \* indicates old/cancelled model (only service parts are available).



## Air Cleaner Part No. and Style Description Service Part No.

### \*G100028 FHG-STYA

Nut.....	P111852
Gasket, body or cup.....	P101401
Filter, safety.....	P119375
Filter, primary-extended life.....	P182064
Filter, primary-Donaldson Blue®.....	DBA
Filter, primary.....	P181064
Cup.....	P103519
Clamp.....	P106071
Baffle, metal.....	P103135

### \*G100029 FHG-STYA

Nut.....	P111852
Gasket, body or cup.....	P101401
Filter, safety.....	P119375
Filter, primary-extended life.....	P182064
Filter, primary-Donaldson Blue®.....	DBA5233
Filter, primary.....	P181064
Cup.....	P103519
Clamp.....	P106071
Baffle, metal.....	P103135

### \*G100035 FHG-STYA

Vacuator™ Valve.....	P103198
Nut.....	P111852
Gasket, body or cup.....	P101401
Filter, safety.....	P119375
Filter, primary-extended life.....	P182064
Filter, primary-Donaldson Blue®.....	DBA5233
Filter, primary.....	P181064
Dust cup, VacValve, vert.....	P103826
Dust cup, VacValve, horz.....	P103827
Clamp.....	P106071
Baffle, metal.....	P103135

### \*G100036 FHG-STYA

Vacuator™ Valve.....	P103198
Nut.....	P111852
Gasket, body or cup.....	P101401
Filter, safety.....	P119375
Filter, primary-extended life.....	P182064
Filter, primary-Donaldson Blue®.....	DBA5233
Filter, primary.....	P181064
Dust cup, VacValve, vert.....	P103826
Dust cup, VacValve, horz.....	P103827
Clamp.....	P106071
Baffle, metal.....	P103135

### \*G100160 SBG-PER

Vacuator™ Valve.....	P112803
Thumb screw.....	P016984
Inner cover.....	P011798
Gasket, inner cover.....	P101077
Gasket, filter.....	P018182
Cover gasket.....	P018181
Gasket, body or cup.....	P101401
Gasket washer.....	P018462
Gasket kit.....	X002995
Filter, primary-extended life.....	P182071
Filter, primary.....	P181071
Dust cup, VacValve, vert.....	P105011
Dust cup, VacValve, horz.....	P103742
Cup.....	P018577
Cover latch assembly.....	P017617
Cover clip spring.....	P017673
Cover.....	P018180
Clamp, body or cup.....	P101846
Body, upper.....	P101070

## Air Cleaner Part No. and Style Description Service Part No.

### \*G100161 SBG-TUB

Thumb screw.....	P016984
Inner cover.....	P101798
Gasket, inner cover.....	P101077
Gasket, filter.....	P018182
Cover gasket.....	P018181
Gasket, body or cup.....	P101401
Gasket washer.....	P018462
Filter, primary-extended life.....	P182071
Filter, primary.....	P181071
Cup.....	P018577
Cover latch assembly.....	P017617
Cover clip spring.....	P017673
Cover.....	P018180
Clamp, body or cup.....	P101846
Body, upper.....	P101070
Body, lower.....	P101086

### G100297 FRG Style B

Cover.....	P538200
Elbow, 45°.....	P105545
Elbow, 90°.....	P105533
Elbow, 90° reducing.....	P121482
Filter, primary-Donaldson Blue®.....	DBA5228
Filter, primary.....	P781039
Filter, safety.....	P777639
Gasket, cover.....	P537308
Hump hose.....	P105609
Informer™ indicator 25" H <sub>2</sub> O.....	X002277
Inlet hood, plastic.....	H000468
Latch.....	P777366
Mounting band.....	P004076
Mounting bands, metal.....	P004076
Outlet band clamp.....	P148343
Vacuator™ Valve.....	P776008

### G100317 FPG

Cover.....	P780578
Elbow, 45°.....	P105545
Elbow, 90°.....	P105533
Elbow, 90° reducing.....	P121482
Filter, primary-Donaldson Blue®.....	DBA5228
Filter, primary.....	P781039
Filter, safety.....	P777639
Hump hose.....	P105609
Informer™ indicator 25" H <sub>2</sub> O.....	X002277
Inlet hood, metal.....	H000170
Inlet hood, plastic.....	H000468
Mounting Bands, plastic.....	P780594
Outlet band clamp.....	P148343
Vacuator™ Valve.....	H776008

### G100319 FPG

Cover.....	P780578
Elbow, 45°.....	P105545
Elbow, 90°.....	P105533
Elbow, 90° reducing.....	P121482
Filter, primary-Donaldson Blue®.....	DBA5228
Filter, primary.....	P781039
Filter, safety.....	P777639
Hump hose.....	P105609
Informer™ indicator 25" H <sub>2</sub> O.....	X002277
Inlet hood, metal.....	H000170
Inlet hood, plastic.....	H000468
Mounting Bands, plastic.....	P780594
Outlet band clamp.....	P148343
Vacuator™ Valve.....	H776008

## Air Cleaner Part No. and Style Description Service Part No.

### G100395 FRG Style A

Baffle, metal.....	P602211
Clamp.....	P106071
Dust cup/cover.....	P103827
Elbow, 45°.....	P109021
Elbow, 90°.....	P107844
Elbow, 90° reducing.....	P143895
Filter, primary-Donaldson Blue®.....	DBA5222
Filter, primary.....	P601790
Filter, safety.....	P777639
Hump hose.....	P105610
Informer™ indicator 25" H <sub>2</sub> O.....	X002277
Inlet hood, metal.....	H000170
Inlet hood, plastic.....	H000468
Mounting bands, metal.....	P004076
O-ring.....	P101401
Outlet band clamp.....	P148345
Vacuator™ Valve.....	P103198

### G100398 FRG Style A

Baffle, metal.....	P602211
Clamp.....	P106071
Dust cup/cover.....	P103827
Elbow, 45°.....	P109021
Elbow, 90°.....	P107844
Elbow, 90° reducing.....	P143895
Filter, primary-Donaldson Blue®.....	DBA5222
Filter, primary.....	P601790
Filter, safety (optional).....	P777639
Hump hose.....	P105610
Informer™ indicator 25" H <sub>2</sub> O.....	X002277
Inlet hood, metal.....	H000170
Inlet hood, plastic.....	H000468
Mounting band.....	P004076
Mounting bands, metal.....	P004076
O-ring.....	P101401
Outlet band clamp.....	P148345
Vacuator™ Valve.....	P103198

### \*G110103 FTG

Wing nut.....	P126054
Wing nut.....	P126049
Vacuator™ Valve.....	P103198
SafetySignal indicator.....	X004815
Cover gasket.....	P127329
Filter, safety.....	P124046
Filter, primary-extended life.....	P182070
Filter, primary-Donaldson Blue®.....	DBA5126
Filter, primary.....	P181070
Cover.....	P127331
Clip.....	P154710

### G110119 EPG

Cover.....	P529151
Elbow, 45°.....	P109021
Elbow, 90°.....	P107844
Elbow, 90° reducing.....	P143895
Fastener kit.....	X006452
Filter, primary-Donaldson Blue®.....	DBA5067
Filter, primary - SM.....	P527484
Filter, safety.....	P527680
Hump hose.....	P105610
Informer™ indicator 25" H <sub>2</sub> O.....	X002277
Inlet hood, plastic.....	H000604
Outlet band clamp.....	P148345
Thumb screw.....	P527435
Vacuator™ Valve.....	P525956

**Air Cleaner Part No. and Style Description Service Part No.**
**G110120 EPG**

Cover .....	P529151
Elbow, 45° .....	P109021
Elbow, 90° .....	P107844
Elbow, 90° reducing .....	P143895
Fastener kit .....	X006452
Filter, primary-Donaldson Blue® .....	<b>DBA5067</b>
Filter, primary - SM .....	P527484
Filter, safety .....	P527680
Hump hose .....	P105610
Informer™ indicator 25" H <sub>2</sub> O .....	X002277
Inlet hood, plastic .....	H000604
Outlet band clamp .....	P148345
Thumb screw .....	P527435
Vacuator™ Valve .....	P525956

**G110206 FRG Style B**

Cover .....	P538452
Elbow, 45° .....	P114316
Elbow, 90° .....	P113733
Filter, primary-Donaldson Blue® .....	<b>DBA5105</b>
Filter, primary - SM .....	P532966
Filter, safety .....	P533781
Gasket, cover .....	P526676
Hump hose .....	P114317
Informer™ indicator 25" H <sub>2</sub> O .....	X002277
Inlet hood, metal .....	H000165
Inlet hood, plastic .....	H000469
Latch .....	P536439
Mounting band .....	P004079
Mounting bands, metal .....	P004079
Outlet band clamp .....	P148344
Vacuator™ Valve .....	P158914

**G110214 FRG Style B**

Cover .....	P538452
Elbow, 45° .....	P114316
Elbow, 90° .....	P113733
Filter, primary-Donaldson Blue® .....	<b>DBA5230</b>
Filter, primary .....	P536457
Filter, safety .....	P536492
Gasket, cover .....	P526676
Hump hose .....	P114317
Informer™ indicator 25" H <sub>2</sub> O .....	X002277
Inlet hood, metal .....	H000170
Inlet hood, plastic .....	H000468
Latch .....	P536439
Mounting band .....	P004079
Mounting bands, metal .....	P004079
Outlet band clamp .....	P148344
Vacuator™ Valve .....	P158914

**G110468 & G110469 PowerPleat**

Cover .....	P626094
Elbow, 45° .....	P109021
Elbow, 90° .....	P107844
Filter, primary .....	P626096
Filter, safety .....	P626104
Informer™ indicator 25" H <sub>2</sub> O .....	X002277
Inlet hood, plastic .....	H000468
Inlet hood, metal .....	H000170
O-ring seal .....	P625983
Outlet band clamp .....	P148344
Vacuator™ Valve .....	P776008

**Air Cleaner Part No. and Style Description Service Part No.**
**G110474 & G110475 PowerPleat**

Cover .....	P626094
Elbow, 45° .....	P109021
Elbow, 90° .....	P107844
Filter, primary .....	P628805
Filter, safety .....	P628802
Informer™ indicator 25" H <sub>2</sub> O .....	X002277
Inlet hood, plastic .....	H000468
Inlet hood, metal .....	H000170
Outlet Hump Hose .....	P105610
Outlet band clamp .....	P148344
Vacuator™ Valve .....	P776008

**\*G112000 ECG-KPII**

Stud repair kit .....	X004464
Nut, plastic .....	P119325
Mounting band .....	P004079
Cover gasket .....	P117477
Filter, primary treated .....	P148043

**G112001 ECG Bolt Service Cover**

Elbow, 45° .....	P105548
Elbow, 90° .....	P105536
Filter, primary, no cover, treated .....	P148043
Gasket, cover .....	P155211
Hump hose .....	P105613
Informer™ indicator 25" H <sub>2</sub> O .....	X002277
Inlet hood, metal .....	H000339
Inlet hood, plastic .....	H000607
Kit .....	X006201
Mounting bands, metal .....	P004079
Nut, plastic .....	P119325
Outlet band clamp .....	P148348
Retaining ring .....	P129469

**\*G112401 ECG-KPI**

Latch replacement kit .....	X006201
Filter, primary-extended life .....	P150695
Filter, primary treated .....	P148043
Filter, primary .....	P150694
Cover .....	P150862

**G112404 ECG Latch Service Cover**

Cover .....	P150862
Elbow, 45° .....	P105548
Elbow, 90° .....	P105536
Filter, primary, attached cover .....	P153551
Filter, primary, attached cover-Donaldson Blue® .....	<b>DBA5053</b>
Filter, primary, no cover, treated .....	P154575
Gasket, cover .....	P536493
Hump hose .....	P105613
Informer™ indicator 25" H <sub>2</sub> O .....	X002277
Inlet hood, metal .....	H000339
Inlet hood, plastic .....	H000607
Mounting bands, metal .....	P004079
Outlet band clamp .....	P148348
Spring latch replacement kit .....	X006201

**Air Cleaner Part No. and Style Description Service Part No.**
**G112417 ECG Latch Service Cover**

Cover .....	P150862
Elbow, 45° .....	P105548
Elbow, 90° .....	P105536
Filter, primary, attached cover .....	P150695
Filter, primary, attached cover-Donaldson Blue® .....	<b>DBA5047</b>
Filter, primary, no cover .....	P150694
Filter, primary-Donaldson Blue® .....	<b>DBA5029</b>
Gasket, cover .....	P536493
Hump hose .....	P105613
Informer™ indicator 25" H <sub>2</sub> O .....	X002277
Mounting bands, metal .....	P004079
Outlet band clamp .....	P148348
Spring latch replacement kit .....	X006201

**G112501 ECG Latch Service Cover**

Elbow, 45° .....	P105548
Elbow, 90° .....	P105536
Filter, primary .....	P150694
Filter, primary .....	P150695
Filter, primary-Donaldson Blue® .....	<b>DBA5047</b>
Filter, primary-Donaldson Blue® .....	<b>DBA5029</b>
Filter, primary treated .....	P148043
Gasket, cover .....	P536493
Hump hose .....	P105613
Informer™ indicator 25" H <sub>2</sub> O .....	X002277
Inlet hood, metal .....	H000339
Inlet hood, plastic .....	H000607
Mounting bands, metal .....	P004079
Outlet band clamp .....	P148348
Spring latch replacement kit .....	X006201

**G112504 ECG Latch Service Cover**

Elbow, 45° .....	P105548
Elbow, 90° .....	P105536
Filter, primary, attached blackcover .....	P537791
Filter, primary, attached cover .....	P153551
Filter, primary-Donaldson Blue® .....	<b>DBA5053</b>
Filter, primary, no cover, treated .....	P154575
Gasket, cover .....	P536493
Hump hose .....	P105613
Informer™ indicator 25" H <sub>2</sub> O .....	X002277
Inlet hood, metal .....	H000339
Inlet hood, plastic .....	H000607
Mounting bands, metal .....	P004079
Outlet band clamp .....	P148348
Spring latch replacement kit .....	X006201

**\*G120012 FHG-STYA**

Baffle, metal .....	P106329
Clamp .....	P100808
Cup .....	P106589
Filter, primary .....	P181034
Filter, primary-extended life .....	P182034
Filter, primary-Donaldson Blue® .....	<b>DBA5034</b>
Filter, safety .....	P119374
Gasket, body or cup .....	P017804
Nut .....	P111852

**FILTER DESCRIPTIONS:**

SM=Scheduled Maintenance Donaldson Blue® = High Efficiency, Extended Service

# Air Cleaner Service Parts Listing

Part Numbers with \* indicates old/cancelled model (only service parts are available).



## Air Cleaner Part No. and Style Description Service Part No.

**\*G120014 FHG-STYA**

Baffle, metal.....	P106329
Clamp .....	P100808
Cup.....	P106589
Filter, primary.....	P181034
Filter, primary-extended life .....	P182034
Filter, primary-Donaldson Blue®.....	DBA5034
Filter, safety.....	P119374
Gasket, body or cup.....	P017804
Nut.....	P111852

**\*G120036 FHG-STYA**

Baffle, metal.....	P106329
Clamp .....	P121067
Dust cup, VacValve, horz.....	P109296
Dust cup, VacValve, vert.....	P103828
Filter, primary.....	P181034
Filter, primary-extended life .....	P182034
Filter, primary-Donaldson Blue®.....	DBA5034
Filter, safety.....	P119374
Gasket, body or cup.....	P017804
Nut.....	P111852
Vacuator™ Valve .....	P103198

**\*G120037 FHG-STYA**

Baffle, metal.....	P106329
Clamp .....	P121067
Dust cup, VacValve, horz.....	P109296
Dust cup, VacValve, vert.....	P103828
Filter, primary.....	P181034
Filter, primary-extended life .....	P182034
Filter, primary-Donaldson Blue®.....	DBA5034
Filter, safety.....	P119374
Gasket, body or cup.....	P017804
Nut.....	P111852
Vacuator™ Valve .....	P103198

**G120059 FWG**

Baffle, metal.....	P106329
Clamp .....	P100808
Cup.....	P106589
Dust cup, VacValve, horz.....	P109296
Filter, primary.....	P181035
Filter, primary-extended life .....	P182035
Filter, primary-UL approved.....	P122525
Gasket, body or cup.....	P017804
Wing bolt .....	P018464

**G120063 FWG**

Baffle, metal.....	P106329
Clamp .....	P100808
Cup.....	P106589
Dust cup, VacValve, horz.....	P109296
Filter, primary.....	P181035
Filter, primary-extended life .....	P182035
Filter, primary-UL approved.....	P122525
Gasket, body or cup.....	P017804
Wing bolt .....	P018464

**\*G120075 STG-PER**

Cover gasket.....	P017365
Dust cup, quick release .....	P107375
Filter, primary.....	P181044
Filter, primary-extended life .....	P182044
Filter, safety.....	P119371

## Air Cleaner Part No. and Style Description Service Part No.

Gasket kit.....	X003537
Gasket washer.....	P105740
Gasket, body or cup.....	P017804
Inlet shroud.....	P102881
Mounting band .....	H000349
SafetySignal indicator.....	X004816
Wing nut.....	P109062

**\*G120250 SBG-PER**

Clamp .....	P100808
Cover.....	P017897
Cover clip spring .....	P017673
Cover gasket.....	P017365
Cover latch assembly.....	P017617
Cup.....	P100807
Dust cup, quick release .....	P107375
Dust cup, VacValve, horz.....	P103744
Dust cup, VacValve, vert.....	P105015
Filter, primary.....	P181033
Filter, primary-extended life .....	P182033
Gasket kit.....	X002994
Gasket washer.....	P018462
Gasket, body or cup.....	P017804
Gasket, filter.....	P018033
Gasket, inner cover.....	P100894
Inner cup .....	P101669
Thumb screw .....	P016984
Vacuator™ Valve .....	P112803

**\*G120251 SBG-TUB**

Clamp .....	P100808
Cover.....	P017897
Cover clip spring .....	P017673
Cover gasket.....	P017365
Cover latch assembly.....	P017617
Cup.....	P100807
Filter, primary.....	P181033
Filter, primary-extended life .....	P182033
Gasket washer.....	P018642
Gasket, body or cup.....	P017804
Gasket, filter.....	P018033
Gasket, inner cover.....	P100894
Inner cup .....	P101669
Thumb screw .....	P016984

**G120332 STG-TUB**

Body, lower .....	P110875
Dust cup, quick release .....	P107375
Elbow, 45° .....	P109021
Elbow, 90° .....	P107844
Elbow, 90° reducing .....	P143895
Filter, primary.....	P182044
Filter, primary-Donaldson Blue®.....	DBA5044
Filter, primary - SM .....	P181044
Filter, safety.....	P119371
Gasket washer.....	P105740
Gasket, body or cup.....	P017804
Gasket, cover.....	P017365
Hump hose .....	P105610
Informer™ indicator 25" H <sub>2</sub> O .....	X002277
Inlet hood, metal.....	H000165
Inlet hood, plastic.....	H000469
Mounting band .....	H000349
Mounting bands, metal .....	H000349
Outlet band clamp.....	P148345
SafetySignal indicator.....	X004816
Spring clip & pin.....	X005555
Wing nut.....	P109062

## Air Cleaner Part No. and Style Description Service Part No.

**G120415 FRG Style A**

Baffle, metal.....	P106329
Clamp .....	P121067
Dust cup/cover .....	P109296
Elbow, 45° .....	P109021
Elbow, 90° .....	P107844
Elbow, 90° reducing .....	P143895
Filter, primary-Donaldson Blue®.....	DBA5231
Filter, primary.....	P601767
Filter, safety.....	P601774
Hump hose .....	P105610
Informer™ indicator 25" H <sub>2</sub> O .....	X002277
Inlet hood, metal.....	H000165
Inlet hood, plastic.....	H000469
Mounting band .....	H000349
Mounting bands, metal .....	H000349
O-ring .....	P017804
Outlet band clamp.....	P148345
Vacuator™ Valve .....	P103198

**G120417 FRG Style A**

Baffle, metal.....	P106329
Clamp .....	P121067
Dust cup/cover .....	P109296
Elbow, 45° .....	P109021
Elbow, 90° .....	P107844
Elbow, 90° reducing .....	P143895
Filter, primary-Donaldson Blue®.....	DBA5231
Filter, primary.....	P601767
Filter, safety (optional).....	P601774
Hump hose .....	P105610
Informer™ indicator 25" H <sub>2</sub> O .....	X002277
Inlet hood, metal.....	H000165
Inlet hood, plastic.....	H000469
Mounting band .....	H000349
Mounting bands, metal .....	H000349
O-ring .....	P017804
Outlet band clamp.....	P148345
Vacuator™ Valve .....	P103198

**\*G130043 FTG**

Clip.....	P154710
Cover.....	P127368
Cover gasket.....	P127377
Filter, primary.....	P181082
Filter, primary-extended life .....	P182082
Filter, primary-Donaldson Blue®.....	DBA5127
Filter, safety.....	P138722
SafetySignal indicator.....	X004814
Vacuator™ Valve .....	P103198
Wing nut.....	P126049
Wing nut.....	P126054

**G130079 EPG**

Cover.....	P533916
Elbow, 45° .....	P109021
Elbow, 90° .....	P107844
Elbow, 90° reducing .....	P143895
Fastener kit.....	X006452
Filter, primary - SM .....	P533930
Filter, primary-Donaldson Blue®.....	DBA5109
Filter, safety.....	P533890
Hump hose .....	P105610
Informer™ indicator 25" H <sub>2</sub> O .....	X002277
Inlet hood, metal.....	H000275
Inlet hood, plastic.....	H000066
Outlet band clamp.....	P148345
Thumb screw .....	P527435
Vacuator™ Valve .....	P525956

**Air Cleaner Part No. and Style Description Service Part No.**
**G130089 EPG**

Cover.....	P533916
Elbow, 45°.....	P109021
Elbow, 90°.....	P107844
Elbow, 90° reducing.....	P143895
Fastener kit.....	X006452
Filter, primary - SM.....	P533930
<b>Filter, primary-Donaldson Blue®.....</b>	<b>DBA5109</b>
Filter, safety.....	P533890
Hump hose.....	P105610
Informer™ indicator 25" H <sub>2</sub> O.....	X002277
Inlet hood, metal.....	H000275
Inlet hood, plastic.....	H000606
Outlet band clamp.....	P148345
Thumb screw.....	P527435
Vacuator™ Valve.....	P525956

**G130097 FRG Style B**

Cover.....	P538259
Elbow, 45°.....	P109021
Elbow, 90°.....	P107844
Elbow, 90° reducing.....	P143895
<b>Filter, primary-Donaldson Blue®.....</b>	<b>DBA5221</b>
Filter, primary.....	P537876
Filter, safety.....	P537877
Gasket, cover.....	P537699
Hump hose.....	P105610
Informer™ indicator 25" H <sub>2</sub> O.....	X002277
Inlet hood, metal.....	H000275
Inlet hood, plastic.....	H000606
Latch.....	P776033
Mounting band.....	P013722
Mounting bands, metal.....	P013722
Outlet band clamp.....	P148345
Vacuator™ Valve.....	P776008

**G130107 FRG Style B**

Cover.....	P538259
Elbow, 45°.....	P109021
Elbow, 90°.....	P107844
Elbow, 90° reducing.....	P143895
<b>Filter, primary-Donaldson Blue®.....</b>	<b>DBA5220</b>
Filter, primary.....	P532503
Filter, safety.....	P532504
Gasket, cover.....	P537699
Hump hose.....	P105610
Informer™ indicator 25" H <sub>2</sub> O.....	X002277
Inlet hood, metal.....	H000275
Inlet hood, plastic.....	H000606
Latch.....	P776033
Mounting band.....	P013722
Mounting bands, metal.....	P013722
Outlet band clamp.....	P148345
Vacuator™ Valve.....	P776008

**G130374 & G130375 PowerPleat 13S**

Cover.....	P627756
Elbow, 45°.....	P109021
Elbow, 90°.....	P107844
Filter, primary.....	P628866
Filter, safety.....	P628862
Informer™ indicator 25" H <sub>2</sub> O.....	X002277
Inlet hood, plastic.....	H000469
Inlet hood, metal.....	H000165

**FILTER DESCRIPTIONS:**

SM=Scheduled Maintenance Donaldson Blue® = High Efficiency, Extended Service

**Air Cleaner Part No. and Style Description Service Part No.**

Outlet Hump Hose.....	P105610
Outlet band clamp.....	P148345
O-ring seal.....	P627758
Vacuator™ Valve.....	P776008

**G130373 & G130372 PowerPleat 13L**

Cover.....	P627756 8
Elbow, 45°.....	P109021
Elbow, 90°.....	P107844
Filter, primary.....	P627763 3
Filter, safety.....	P628203 3
Informer™ indicator 25" H <sub>2</sub> O.....	X002277
Inlet hood, plastic.....	H000469
Inlet hood, metal.....	H000165
Outlet Hump Hose.....	P105610
Outlet band clamp.....	P148345
O-ring seal.....	P627758
Vacuator™ Valve.....	P776008

**G132000 ECG Bolt Service Cover**

Elbow, 45°.....	P105548
Elbow, 90°.....	P105536
Filter, primary, no cover.....	P142100
<b>Filter, primary-Donaldson Blue®.....</b>	<b>DBA5027</b>
Gasket, cover.....	P120604
Hump hose.....	P105613
Informer™ indicator 25" H <sub>2</sub> O.....	X002277
Inlet hood, metal.....	H000339
Inlet hood, plastic.....	H000607
Mounting bands, metal.....	P013722
Nut, plastic.....	P119325
Outlet band clamp.....	P148348
Retaining ring.....	P129469

**\*G140022 FHG-STYA**

Nut.....	P111852
Gasket, body or cup.....	P017335
Filter, safety.....	P119373
Filter, primary-extended life.....	P182046
Filter, primary.....	P181046
Cup/baffle.....	P118784
Clamp.....	P100866

**\*G140023 FHG-STYA**

Nut.....	P111852
Gasket, body or cup.....	P017335
Filter, safety.....	P119373
Filter, primary-extended life.....	P182046
Filter, primary.....	P181046
Cup/baffle.....	P118784
Clamp.....	P100866

**\*G140054 FHG-STYA**

Vacuator™ Valve.....	P103198
Nut.....	P111852
Gasket, body or cup.....	P017335
Filter, safety.....	P119373
Filter, primary-extended life.....	P182046
Filter, primary.....	P181046
Dust cup, VacValve, vert.....	P103829
Dust cup, VacValve, horz.....	P109297
Clamp.....	P100866
Baffle, metal.....	P106771

**Air Cleaner Part No. and Style Description Service Part No.**
**\*G140055 FHG-STYA**

Vacuator™ Valve.....	P103198
Nut.....	P111852
Gasket, body or cup.....	P017335
Filter, safety.....	P119373
Filter, primary-extended life.....	P182046
<b>Filter, primary-Donaldson Blue®.....</b>	<b>DBA5046</b>
Filter, primary.....	P181046
Dust cup, VacValve, vert.....	P103829
Dust cup, VacValve, horz.....	P109297
Clamp.....	P100866
Baffle, metal.....	P106771

**G140076 STG-PER**

Body, lower.....	P102256
Clamp, cup.....	P100866
Cover latch assembly.....	P017617
Dust cup.....	P100860
Elbow, 45°.....	P105547
Elbow, 90°.....	P105535
Filter, primary.....	P182041
<b>Filter, primary-Donaldson Blue®.....</b>	<b>DBA7041</b>
Filter, primary - SM.....	P181041
Filter, safety.....	P119370
Gasket kit.....	X003538
Gasket washer.....	P105740
Gasket, body or cup.....	P017335
Gasket, cover.....	P016972
Hump hose.....	P105612
Informer™ indicator 25" H <sub>2</sub> O.....	X002277
Inlet shroud.....	P102870
Mounting band.....	H000350
Mounting bands, metal.....	H000350
Outlet band clamp.....	P148347
SafetySignal indicator.....	X004816
Spring clip & pin.....	X005555
Wing nut.....	P109062

**G140083 FWG**

Wing bolt.....	P018464
Gasket, body or cup.....	P017335
Filter, primary-UL approved.....	P122529
Filter, primary-extended life.....	P182000
Filter, primary.....	P181000
Cup.....	P106773
Clamp.....	P100866
Baffle, metal.....	P106771

**G140195 FVG**

Elbow, 45°.....	P105547
Elbow, 90°.....	P105535
Filter, primary.....	P182043
Filter, primary - ES & HE.....	DBA5043
Filter, primary - SM.....	P181043
Filter, safety.....	P124860
Gasket washer.....	P105740
Hump hose.....	P105612
Informer™ indicator 25" H <sub>2</sub> O.....	X002277
Inlet hood, metal.....	H000339
Inlet hood, plastic.....	H000607
Mounting band.....	H000350
Mounting bands, metal.....	H000350
Outlet band clamp.....	P148347
Pin.....	P109107
Retainer.....	P105738
SafetySignal indicator.....	X004816
Vacuator™ Valve.....	P103198
Wing nut.....	P116175



# Air Cleaner Service Parts Listing

Part Numbers with \* indicates old/cancelled model (only service parts are available).



## Air Cleaner Part No. and Style Description Service Part No.

### \*G140260 SBG-PER

Vacuator™ Valve .....	P112803
Thumb screw .....	P016984
Inner cup .....	P101670
Gasket, inner cover.....	P100859
Gasket, filter.....	P018029
Cover gasket.....	P016972
Gasket, body or cup.....	P017335
Gasket washer.....	P018462
Gasket kit.....	X002993
Filter, primary-extended life .....	P182037
Filter, primary .....	P181037
Dust cup, VacValve, vert.....	P105016
Dust cup, VacValve, horz .....	P103746
Dust cup, quick release .....	P107376
Cup.....	P100860
Cover latch assembly.....	P017617
Cover clip spring .....	P017673
Clamp, body.....	P100861
Clamp .....	P100866

### \*G140261 SBG-TUB

Thumb screw .....	P016984
Inner cup .....	P101670
Gasket, inner cover.....	P100859
Gasket, filter.....	P018029
Cover gasket.....	P016972
Gasket, body or cup.....	P017335
Gasket washer.....	P018462
Filter, primary-extended life .....	P182037
Filter, primary .....	P181037
Cup.....	P100860
Cover latch assembly.....	P017617
Cover clip spring .....	P017673
Clamp, body.....	P100861
Clamp .....	P100866
Body, lower .....	P101032

### \*G140270 SBG-PER

Vacuator™ Valve .....	P112803
Thumb screw .....	P016984
Inner cup .....	P101670
Gasket, inner cover.....	P100859
Gasket, filter.....	P018029
Cover gasket.....	P016972
Gasket, body or cup.....	P017335
Gasket washer.....	P018462
Gasket kit.....	X002993
Filter, primary-extended life .....	P182032
Filter, primary .....	P181032
Dust cup, VacValve, vert.....	P105016
Dust cup, VacValve, horz .....	P103746
Dust cup, quick release .....	P107376
Cup.....	P100860
Cover latch assembly.....	P017617
Cover clip spring .....	P017673
Clamp, body.....	P100861
Clamp .....	P100866
Body, lower .....	P100934

## Air Cleaner Part No. and Style Description Service Part No.

### G140445 STG-TUB

Body, lower .....	P114100
Cover latch assembly .....	P017617
Dust cup.....	P100860
Filter, primary - SM .....	P181041
Filter, primary-Donaldson Blue® .....	DBA7041
Filter, primary .....	P182041
Filter, safety.....	P119370
Gasket kit.....	X003538
Gasket washer.....	P105740
Gasket, body or cup.....	P017335
Gasket, cover.....	P016972
Mounting band .....	H000350
SafetySignal indicator.....	X004816
Spring clip & pin.....	X005555
Wing nut .....	P109062

### G140523 FRG Style A

Baffle, metal.....	P106771
Clamp .....	P100866
Dust cup/cover.....	P109297
Filter, primary-Donaldson Blue® .....	DBA5220
Filter, primary .....	P532503
Filter, safety.....	P532504
Mounting band .....	H000350
O-ring .....	P017335
Vacuator™ Valve.....	P103198
Elbow, 45° .....	P105547
Elbow, 90° .....	P105535
Hump hose .....	P105612
Informer™ indicator 25" H <sub>2</sub> O .....	X002277
Inlet hood, metal.....	H000275
Inlet hood, plastic.....	H000606
Mounting bands, metal .....	H000350
Outlet band clamp.....	P148347

### G140526 FRG Style A

Baffle, metal.....	P106771
Clamp .....	P100866
Dust cup/cover.....	P109297
Elbow, 45° .....	P105547
Elbow, 90° .....	P105535
Filter, primary-Donaldson Blue® .....	DBA5220
Filter, primary .....	P532503
Filter, safety (optional).....	P532504
Hump hose .....	P105612
Informer™ indicator 25" H <sub>2</sub> O .....	X002277
Inlet hood, metal.....	H000275
Inlet hood, plastic.....	H000606
Mounting band .....	H000350
Mounting bands, metal .....	H000350
O-ring .....	P017335
Outlet band clamp.....	P148347
Vacuator™ Valve .....	P103198

### G150048 EPG

Cover.....	P523096
Elbow, 45° .....	P105548
Elbow, 90° .....	P105536
Fastener kit.....	X006452
Filter, primary-Donaldson Blue® .....	DBA5069
Filter, primary - SM .....	P527682
Filter, safety.....	P527683
Hump hose .....	P105613
Informer™ indicator 25" H <sub>2</sub> O .....	X002277
Inlet hood, metal.....	H000339

## Air Cleaner Part No. and Style Description Service Part No.

Inlet hood, plastic.....	H000607
Outlet band clamp.....	P148348
Thumb screw.....	P527435
Vacuator™ Valve .....	P525956

### G150049 EPG

Cover .....	P523096
Elbow, 45° .....	P105548
Elbow, 90° .....	P105536
Fastener kit.....	X006452
Filter, primary - SM .....	P527682
Filter, primary-Donaldson Blue® .....	DBA5069
Filter, safety.....	P527683
Thumb screw.....	P527435
Hump hose .....	P105613
Informer™ indicator 25" H <sub>2</sub> O .....	X002277
Inlet hood, metal.....	H000339
Inlet hood, plastic.....	H000607
Outlet band clamp.....	P148348
Vacuator™ Valve.....	P525956

### \*G150039 FTG

Clip.....	P154710
Cover .....	P128293
Filter, primary-Donaldson Blue® .....	DBA5128
Filter, primary .....	P127308
Filter, safety.....	P127309
SafetySignal indicator.....	X004814
Vacuator™ Valve .....	P103198
Wing nut .....	P126049
Wing nut .....	P126054

### G150092 FRG Style B

Cover .....	P777920
Elbow, 45° .....	P105547
Elbow, 90° .....	P105535
Filter, primary-Donaldson Blue® .....	DBA5116
Filter, primary .....	P777868
Filter, safety.....	P777869
Hump hose .....	P105612
Informer™ indicator 25" H <sub>2</sub> O .....	X002277
Inlet hood, metal.....	H000339
Inlet hood, plastic.....	H000607
Latch.....	P776033
Mounting band .....	P016845
Mounting bands, metal .....	P016845
Outlet band clamp .....	P148347
Vacuator™ Valve .....	P776008

### \*G160035 SBG-TUB

Thumb screw .....	P016984
Inner cup .....	P101666
Gasket, inner cover.....	P100777
Gasket, filter.....	P017368
Cover gasket.....	P017367
Gasket, body or cup.....	P017336
Gasket washer.....	P018642
Filter, primary-extended life .....	P182036
Filter, primary .....	P181036
Cup.....	P100794
Cover latch assembly.....	P017617
Cover clip spring .....	P017673
Cover .....	P017831
Clamp, cup.....	P100789
Clamp, body.....	P100780
Body, lower .....	P115022

**Air Cleaner Part No. and Style**  
 Description Service Part No.

<b>G160048 FHG-STYA</b>	
Nut.....	P111852
Gasket, body or cup.....	P017336
Filter, safety.....	P119372
Filter, primary-extended life.....	P182002
Filter, primary-Donaldson Blue®.....	DBA5002
Filter, primary.....	P181002
Clamp, cup.....	P100789
Baffle, metal.....	P106637

<b>*G160049 FHG-STYA</b>	
Vacuator™ Valve.....	P103198
Nut.....	P111852
Gasket, body or cup.....	P017336
Filter, safety.....	P119372
Filter, primary-extended life.....	P182002
Filter, primary-Donaldson Blue®.....	DBA5002
Filter, primary treated.....	P122708
Filter, primary.....	P181002
Cover/cup.....	P206952
Clamp, cup.....	P100789
Baffle, metal.....	P106637

<b>*G160057 FHG-STYA</b>	
Nut.....	P111852
Gasket, body or cup.....	P017336
Filter, safety.....	P119372
Filter, primary-extended life.....	P182002
Filter, primary-Donaldson Blue®.....	DBA5002
Filter, primary treated.....	P122708
Filter, primary.....	P181002
Cup.....	P106639
Clamp, cup.....	P100789
Baffle, metal.....	P106637

<b>G160077 STG-PER</b>	
Body, lower.....	P115023
Clamp, body.....	P100780
Clamp, cup.....	P100789
Cover.....	P109153
Cover latch assembly.....	P017617
Dust cup.....	P100794
Dust cup, quick release.....	P107377
Dust cup, VacValve, horz.....	P103530
Dust cup, VacValve, vert.....	P104973
Elbow, 45°.....	P105548
Elbow, 90°.....	P105536
Filter, primary.....	P182039
Filter, primary-Donaldson Blue®.....	DBA7039
Filter, primary - SM.....	P181039
Filter, safety.....	P114931
Gasket kit.....	X003539
Gasket washer.....	P105740
Gasket, body or cup.....	P017336
Gasket, cover.....	P017367
Hump hose.....	P105613
Informer™ indicator 25" H <sub>2</sub> O.....	X002277
Inlet shroud.....	P101759
Mounting band.....	H000351
Mounting bands, metal.....	H000351
Outlet band clamp.....	P148348
SafetySignal indicator.....	X004816
Spring clip & pin.....	X005555
Wing nut.....	P109062

**Air Cleaner Part No. and Style**  
 Description Service Part No.

<b>*G160078 FHG-STYA</b>	
Vacuator™ Valve.....	P103198
Nut.....	P111852
Gasket, body or cup.....	P017336
Filter, safety.....	P119372
Filter, primary-extended life.....	P182002
Filter, primary-Donaldson Blue®.....	DBA5002
Filter, primary treated.....	P122708
Filter, primary.....	P181002
Cup.....	P106639
Cover/cup.....	P206952
Clamp, cup.....	P100789
Baffle, metal.....	P106637

<b>G160104 FWG</b>	
Thumb screw.....	P016984
Gasket, body or cup.....	P017336
Gasket washer.....	P018472
Filter, primary-extended life.....	P182001
Filter, primary.....	P181001
Dust cup, VacValve, horz.....	P106952
Cup.....	P106639
Clamp, cup.....	P100789
Baffle, metal.....	P106637

<b>*G160107 FWG</b>	
Thumb screw.....	P016984
Gasket, body or cup.....	P017336
Gasket washer.....	P018472
Filter, primary-extended life.....	P182001
Filter, primary.....	P181001
Dust cup, VacValve, horz.....	P106952
Cup.....	P106639
Clamp, cup.....	P100789
Baffle, metal.....	P106637

<b>*G160158 STG-TUB</b>	
Wing nut.....	P109062
Wing nut.....	P109062
SafetySignal indicator.....	X004816
Mounting band.....	H000351
Cover gasket.....	P017367
Gasket, body or cup.....	P017336
Gasket washer.....	P105740
Gasket kit.....	X003539
Filter, safety.....	P114931
Filter, primary-extended life.....	P182039
Filter, primary.....	P181039
Dust cup, VacValve, vert.....	P104973
Dust cup, VacValve, horz.....	P103530
Dust cup, quick release.....	P107377
Cover.....	P109153
Body, lower.....	P101057
Air Inlet Hood.....	H000607

<b>*G160254 FHG-STYA</b>	
Vacuator™ Valve.....	P113803
Nut.....	P111852
Gasket, body or cup.....	P017336
Filter, primary-extended life.....	P182002
Filter, primary-Donaldson Blue®.....	DBA5002
Filter, primary treated.....	P122708
Filter, primary.....	P181002
Dust cup, VacValve, vert.....	P113741

**Air Cleaner Part No. and Style**  
 Description Service Part No.

<b>*G160331 SBG-TUB</b>	
Thumb screw.....	P016984
Inner cup.....	P101666
Gasket, inner cover.....	P100777
Gasket, filter.....	P017368
Cover gasket.....	P017367
Gasket, body or cup.....	P017336
Gasket washer.....	P018642
Filter, primary-extended life.....	P182031
Filter, primary.....	P181031
Cup.....	P100794
Cover latch assembly.....	P017617
Cover clip spring.....	P017673
Cover.....	P107831
Clamp, cup.....	P100789
Clamp, body.....	P100780
Body, lower.....	P101057

<b>*G160340 SBG-PER</b>	
Vacuator™ Valve.....	P112803
Thumb screw.....	P016984
Inner cup.....	P101666
Gasket, inner cover.....	P100777
Gasket, filter.....	P017368
Cover gasket.....	P017367
Gasket, body or cup.....	P017336
Gasket washer.....	P018462
Gasket kit.....	X002992
Filter, primary-extended life.....	P182031
Filter, primary.....	P181031
Dust cup, VacValve, vert.....	P104973
Dust cup, VacValve, horz.....	P103530
Dust cup, quick release.....	P107377
Cup.....	P100794
Cover latch assembly.....	P017617
Cover clip spring.....	P017673
Cover.....	P017831
Clamp, cup.....	P100789
Clamp, body.....	P100780

<b>*G160359 SBG-PER</b>	
Vacuator™ Valve.....	P112803
Thumb screw.....	P016984
Inner cup.....	P101666
Gasket, inner cover.....	P100777
Gasket, filter.....	P017368
Cover gasket.....	P017367
Gasket, body or cup.....	P017336
Gasket washer.....	P018462
Gasket kit.....	X002992
Filter, primary-extended life.....	P182036
Filter, primary.....	P181036
Dust cup, VacValve, vert.....	P104973
Dust cup, VacValve, horz.....	P103530
Dust cup, quick release.....	P107377
Cup.....	P100794
Cover clip spring.....	P017673
Cover.....	P017831
Clamp, cup.....	P100789
Clamp, body.....	P100780
Body, lower.....	P115023

**FILTER DESCRIPTIONS:**

SM=Scheduled Maintenance Donaldson Blue® = High Efficiency, Extended Service

# Air Cleaner Service Parts Listing

Part Numbers with \* indicates old/cancelled model (only service parts are available).



## Air Cleaner Part No. and Style Description Service Part No.

### G160376 FVG

Elbow, 45°	P105548
Elbow, 90°	P105536
Filter, primary-Donaldson Blue®	DBA5136
Filter, primary	P124867
Filter, safety	P124866
Gasket washer	P105740
Hump hose	P105613
Informer™ indicator 25" H <sub>2</sub> O	X002277
Inlet hood, metal	H000339
Inlet hood, plastic	H000607
Mounting band	H000351
Mounting bands, metal	H000351
Outlet band clamp	P148348
Pin	P109107
Retainer	P105738
SafetySignal indicator	X004816
Vacuator™ Valve	P103198
Wing nut	P116175

### \*G160443 STG-PER

Cover gasket	P017367
Dust cup, quick release	P107377
Dust cup, VacValve, horz	P103530
Dust cup, VacValve, vert	P104973
Filter, primary	P181039
Filter, primary-extended life	P182039
Filter, primary-Donaldson Blue®	DBA7039
Filter, safety	P114931
Gasket kit	X003539
Gasket washer	P105740
Gasket, body or cup	P017336
Inlet shroud	P101759
Mounting band	H000351
SafetySignal indicator	X004816
Wing nut	P109062

### G160445 STG-TUB

Cover	P109153
Cover, latch assembly	P017617
Dust cup	P100794
Dust cup, quick release	P107377
Dust cup, VacValve, horz	P103530
Dust cup, VacValve, vert	P104973
Filter, primary	P181039
Filter, primary-Donaldson Blue®	DBA7039
Filter, primary - SM	P182039
Filter, safety	P114931
Gasket kit	X003539
Gasket, body or cup	P017336
Gasket, cover	P017367
Mounting band	H000351
Spring clip & pin	X005555

### G160587 FVG

Elbow, 45°	P105548
Elbow, 90°	P105536
Filter, primary	P182049
Filter, primary-Donaldson Blue®	DBA5049
Filter, primary - SM	P181049
Filter, safety	P116446
Gasket washer	P105740
Hump hose	P105613
Informer™ indicator 25" H <sub>2</sub> O	X002277

## Air Cleaner Part No. and Style Description Service Part No.

Inlet hood, metal	H000339
Inlet hood, plastic	H000607
Mounting band	H000351
Mounting bands, metal	H000351
Outlet band clamp	P148348
Pin	P109107
Retainer	P105738
Vacuator™ Valve	P105220
Wing nut	P116175

### \*G160588 STG-TUB

Air Inlet Hood	H000607
Body, lower	P115022
Cover	P109153
Cover gasket	P017367
Dust cup, quick release	P107377
Dust cup, VacValve, horz	P103530
Dust cup, VacValve, vert	P104973
Filter, primary-extended life	P182039
Filter, safety	P114931
Gasket kit	X003539
Gasket washer	P105740
Gasket, body or cup	P017336
Mounting band	H000351
SafetySignal indicator	X004816
Wing nut	P109062

### G160679 FRG Style A

Baffle, metal	P106637
Clamp	P100789
Dust cup/cover	P106952
Elbow, 45°	P105548
Elbow, 90°	P105536
Filter, primary-Donaldson Blue®	DBA5229
Filter, primary	P549523
Filter, safety	P549530
Hump hose	P105613
Informer™ indicator 25" H <sub>2</sub> O	X002277
Inlet hood, metal	H000339
Inlet hood, plastic	H000607
Mounting band	H000351
Mounting bands, metal	H000351
O-ring	P017336
Outlet band clamp	P148348
Vacuator™ Valve	P103198

### G161006 STG-PER

Body, lower	P115023
Clamp, body	P100780
Clamp, cup	P100789
Dust cup	P100794
Dust cup, quick release	P107377
Dust cup, VacValve, horz	P103530
Dust cup, VacValve, vert	P104973
Elbow, 45°	P112606
Elbow, 90°	P112605
Filter, primary	P182042
Filter, primary-Donaldson Blue®	DBA7042
Filter, primary - SM	P181042
Filter, safety	P128408
Gasket kit	X003539
Gasket washer	P105740
Gasket, body or cup	P017336
Gasket, cover	P017367
Hump hose	P112608
Informer™ indicator 25" H <sub>2</sub> O	X002277
Inlet shroud	P101759
Mounting band	H000351

## Air Cleaner Part No. and Style Description Service Part No.

Mounting bands, metal	H000351
Outlet band clamp	P629991
SafetySignal indicator	X004816
Wing nut	P109062

### G161020 STG-TUB

Dust cup	P100794
Dust cup, quick release	P107377
Dust cup, VacValve, horz	P103530
Dust cup, VacValve, vert	P104973
Elbow, 45°	P105547
Elbow, 90°	P105535
Filter, primary	P182042
Filter, primary-Donaldson Blue®	DBA7042
Filter, primary - SM	P181042
Filter, safety	P128408
Gasket kit	X003539
Gasket washer	P105740
Gasket, body or cup	P017336
Gasket, cover	P017367
Hump hose	P105612
Informer™ indicator 25" H <sub>2</sub> O	X002277
Mounting band	H000351
Mounting bands, metal	H000351
Outlet band clamp	P148347
SafetySignal indicator	X004816
Wing nut	P109062

### G180031 FRG Style B

Cover	P783185
Elbow, 45°	P112606
Elbow, 90°	P112605
Filter, primary-Donaldson Blue®	DBA5156
Filter, primary	P781098
Filter, safety	P781102
Hump hose	P112608
Informer™ indicator 25" H <sub>2</sub> O	X002277
Inlet hood, plastic	H001053
Mounting band	H770037
Mounting bands, metal	H770037
Outlet band clamp	P629991
Vacuator™ Valve	P105220

### G200008 SRG

Body, lower	P117785
Clamp	P100808
Clip	P105738
Dust cup, quick release	P107375
Elbow, 45°	P112606
Elbow, 90°	P112605
Filter, primary	P182038
Filter, primary-Donaldson Blue®	DBA7038
Filter, primary - SM	P181038
Filter, safety	P115070
Gasket washer	P105740
Gasket, body	P117791
Gasket, body	P115098
Gasket, body or cup	P017804
Gasket, QR cup	P112789
Hump hose	P112608
Informer™ indicator 25" H <sub>2</sub> O	X002277
Outlet band clamp	P629991
Rain shroud, front	P119876
Rain shroud, left side	P119875
Rain shroud, right side	P119874
SafetySignal indicator	X004816
Vacuator™ Valve	P103198
Wing nut	P116175

#### FILTER DESCRIPTIONS:

SM=Scheduled Maintenance Donaldson Blue® = High Efficiency, Extended Service

**Air Cleaner Part No. and Style Description Service Part No.**

**G200013 SRG**

Body, lower .....	P117785
Clamp .....	P100808
Clip .....	P105738
Dust cup, quick release .....	P107375
Elbow, 45° .....	P114313
Elbow, 90° .....	P114314
Filter, primary .....	P182040
Filter, primary-Donaldson Blue® .....	<b>DBA7040</b>
Filter, primary - SM .....	P181040
Filter, safety .....	P117781
Gasket washer .....	P105740
Gasket, body .....	P117791
Gasket, body .....	P115098
Gasket, body or cup .....	P017804
Gasket, QR cup .....	P112789
Hump hose .....	P111414
Informer™ indicator 25" H <sub>2</sub> O .....	X002277
Outlet band clamp .....	P148350
Rain shroud, front .....	P119876
Rain shroud, left side .....	P119875
Rain shroud, right side .....	P119874
SafetySignal indicator .....	X004816
Vacuator™ Valve .....	P103198
Wing nut .....	P116175

**\*G200016 SRG**

Body, upper .....	P117760
Clamp .....	P100808
Clip .....	P105738
Dust cup, quick release .....	P107375
Dust cup, VacValve, vert .....	P105015
Filter, primary .....	P181040
Filter, primary-extended life .....	P182040
Filter, safety .....	P117781
Gasket .....	P117791
Gasket kit .....	X003725
Gasket washer .....	P105740
Gasket, body .....	P115098
Gasket, body or cup .....	P017804
Nut .....	P115063
Rain shield, front .....	P119876
Rain shield, left side .....	P119874
Rain shield, right side .....	P119875
SafetySignal indicator .....	X004816
Vacuator™ Valve .....	P103198
Wing nut .....	P116175

**G200086, G200087 SSG**

Body gasket strips (two, short) .....	P115098
Body gasket strips (two, long) .....	P117791
Cover .....	P603716
Cover chain .....	P017281
Chain connector .....	P017283
Dust cup .....	P158089
Dust cup gasket .....	P017804
Dust cup clamp .....	P100808
Vacuator Valve .....	P103198
Filter, primary - RadialSeal .....	P608306
Filter, primary-Donaldson Blue® .....	<b>DBA7152</b>
Filter, safety - RadialSeal .....	P608305
Lower body assembly .....	P117785
Rain shroud, right side .....	P119874
Rain shroud, front .....	P119876
Rain shroud, left side .....	P119875

**Air Cleaner Part No. and Style Description Service Part No.**

**G200088 (longer upper unit)**

**SSG**

Body gasket strips (two, short) .....	P603504
Body gasket strips (two, long) .....	P117791
Cover .....	P603716
Cover chain .....	P017281
Chain connector .....	P017283
Dust cup .....	P158128
Dust cup gasket .....	P017336
Dust cup clamp .....	P100789
Vacuator Valve .....	P103198
Filter, primary - RadialSeal .....	P609519
Filter, primary-Donaldson Blue® .....	<b>DBA7153</b>
Filter, safety - RadialSeal .....	P609518
Lower body assembly .....	P603505
Rain shroud, right side .....	P610776
Rain shroud, front .....	P119876
Rain shroud, left side .....	P610777
Elbow, 45° .....	P114313
Elbow, 90° .....	P114314
Hump hose .....	P111414
Informer™ indicator 25" H <sub>2</sub> O .....	X002277
Outlet band clamp .....	P148350

**G210007, G210010 FTG**

Filter, primary-extended life .....	P182040
Filter, primary-Donaldson Blue® .....	<b>DBA7040</b>
Filter, safety .....	P117781
Gasket washer .....	P105740
SafetySignal indicator .....	X004816
Vacuator™ Valve .....	P105220
Wing nut .....	P116175

**G290000 SRG**

Body, lower .....	P115110
Clamp .....	P100808
Clip .....	P105738
Dust cup, quick release .....	P107375
Elbow, 45° .....	P112606
Elbow, 90° .....	P112605
Filter, primary .....	P182038
Filter, primary-Donaldson Blue® .....	<b>DBA7038</b>
Filter, primary - SM .....	P181038
Filter, safety .....	P115070
Gasket washer .....	P105740
Gasket, body .....	P115096
Gasket, body .....	P115098
Gasket, body or cup .....	P017804
Gasket, QR cup .....	P112789
Hump hose .....	P112608
Informer™ indicator 25" H <sub>2</sub> O .....	X002277
Outlet band clamp .....	P629991
Rain shroud, front .....	P119877
Rain shroud, left side .....	P119875
Rain shroud, right side .....	P119874
SafetySignal indicator .....	X004816
Vacuator™ Valve .....	P103198
Wing nut .....	P116175

**Air Cleaner Part No. and Style Description Service Part No.**

**\*G290001 SRG**

Wing nut .....	P116175
Vacuator™ Valve .....	P103198
SafetySignal indicator .....	X004816
Rain shield, right side .....	P119875
Rain shield, left side .....	P119874
Rain shield, front .....	P119877
Gasket, body or cup .....	P017804
Gasket, body .....	P115098
Gasket, body .....	P115096
Gasket washer .....	P105740
Gasket kit .....	X003726
Filter, safety .....	P115070
Filter, primary-extended life .....	P182038
Filter, primary .....	P181038
Dust cup, VacValve, vert .....	P105015
Dust cup, quick release .....	P107375
Clip .....	P105738
Clamp .....	P100808
Body, upper .....	P115107

**\*G290010 SRG**

Wing nut .....	P116175
Vacuator™ Valve .....	P103198
SafetySignal indicator .....	X004816
Rain shield, right side .....	P119875
Rain shield, left side .....	P119874
Rain shield, front .....	P119877
Gasket, body or cup .....	P017804
Gasket, body .....	P115098
Gasket, body .....	P115096
Gasket washer .....	P105740
Gasket kit .....	X003726
Filter, safety .....	P115070
Filter, primary-extended life .....	P182038
Filter, primary .....	P181038
Dust cup, VacValve, vert .....	P105015
Dust cup, quick release .....	P107375
Clip .....	P105738
Clamp .....	P100808
Body, upper .....	P115107

**G290012 SRG**

Clamp .....	P100808
Clip .....	P105738
Dust cup, quick release .....	P107375
Elbow, 45° .....	P114313
Elbow, 90° .....	P114314
Filter, primary .....	P182040
Filter, primary-Donaldson Blue® .....	<b>DBA7040</b>
Filter, primary - SM .....	P181040
Filter, safety .....	P117781
Gasket washer .....	P105740
Gasket, body .....	P115096
Gasket, body .....	P115098
Gasket, body or cup .....	P017804
Gasket, QR cup .....	P112789
Hump hose .....	P111414
Informer™ indicator 25" H <sub>2</sub> O .....	X002277
Outlet band clamp .....	P148350
Rain shroud, front .....	P119877
Rain shroud, left side .....	P119875
Rain shroud, right side .....	P119874
SafetySignal indicator .....	X004816
Vacuator™ Valve .....	P103198
Wing nut .....	P116175



# Air Cleaner Service Parts Listing

Part Numbers with \* indicates old/cancelled model (only service parts are available).

## Air Cleaner Part No. and Style Description Service Part No.

### G290023 SRG

Clamp .....	P100808
Clip .....	P105738
Dust cup, quick release .....	P107375
Elbow, 45° .....	P112606
Elbow, 90° .....	P112605
Filter, primary .....	P182038
<b>Filter, primary-Donaldson Blue® .....</b>	<b>DBA7038</b>
Filter, primary - SM .....	P181038
Filter, safety .....	P115070
Gasket washer .....	P105740
Gasket, body .....	P115096
Gasket, body .....	P115098
Gasket, body or cup .....	P017804
Gasket, QR cup .....	P112789
Hump hose .....	P112608
Informer™ indicator 25" H <sub>2</sub> O .....	X002277
Outlet band clamp .....	P629991
Rain shroud, front .....	P119877
Rain shroud, left side .....	P119875
Rain shroud, right side .....	P119874
SafetySignal indicator .....	X004816
Vacuator™ Valve .....	P103198
Wing nut .....	P116175

### G290052, G290053 SSG

Body gasket strips (two, long) .....	P115096
Body gasket strips (two, short) .....	P115098
Cover .....	P603716
Cover chain .....	P017281
Chain connector .....	P017283
Dust cup (3 on unit) .....	P158089
Dust cup gasket (3 on unit) .....	P017804
Dust cup clamp (3 on unit) .....	P100808
Vacuator Valve (3 on unit) .....	P103198
Filter, primary - RadialSeal .....	P608306
<b>Filter, primary-Donaldson Blue® .....</b>	<b>DBA7152</b>
Filter, safety - RadialSeal .....	P608305
Lower body assembly .....	P118552
Rain shroud, right side .....	P119874
Rain shroud, front .....	P119877
Rain shroud, left side .....	P119875
Informer™ indicator 25" H <sub>2</sub> O .....	X002277

## Air Cleaner Part No. and Style Description Service Part No.

### G290055 (longer upper body) SSG

Body gasket strips (two, long) .....	P115096
Body gasket strips (two, short) .....	P603504
Chain connector .....	P017283
Cover .....	P603716
Cover chain .....	P017281
Dust cup (3 on unit) .....	P158089
Dust cup clamp (3 on unit) .....	P100808
Dust cup gasket (3 on unit) .....	P017804
Vacuator Valve (3 on unit) .....	P103198
Elbow, 45° .....	P114313
Elbow, 90° .....	P114314
Filter, primary - RadialSeal .....	P609519
<b>Filter, primary-Donaldson Blue® .....</b>	<b>DBA7153</b>
Filter, safety - RadialSeal .....	P609518
Hump hose .....	P111414
Informer™ indicator 25" H <sub>2</sub> O .....	X002277
Lower body assembly .....	P609508
Outlet band clamp .....	P148350
Rain shroud, front .....	P119877
Rain shroud, left side .....	P610777
Rain shroud, right side .....	P610776

### G290057 SSG

Body gasket strips (two, long) .....	P115096
Body gasket strips (two, short) .....	P115098
Chain connector .....	P017283
Cover .....	P603716
Cover chain .....	P017281
Dust cup (3 on unit) .....	P158089
Dust cup clamp (3 on unit) .....	P100808
Dust cup gasket (3 on unit) .....	P017804
Vacuator Valve (3 on unit) .....	P103198
Elbow, 45° .....	P112606
Elbow, 90° .....	P112605
Filter, primary - RadialSeal .....	P608306
<b>Filter, primary-Donaldson Blue® .....</b>	<b>DBA7152</b>
Filter, safety - RadialSeal .....	P608305
Hump hose .....	P112608
Informer™ indicator 25" H <sub>2</sub> O .....	X002277
Lower body assembly .....	P115110
Outlet band clamp .....	P629991
Rain shroud, front .....	P119877
Rain shroud, left side .....	P119875
Rain shroud, right side .....	P119874

### X007953 PowerCore® Kit-Ford

Filter, primary - RadialSeal .....	P606122
------------------------------------	---------

#### FILTER DESCRIPTIONS:

SM=Scheduled Maintenance Donaldson Blue® = High Efficiency, Extended Service

# Air Cleaner Family Upgrades

These old air cleaner families are being phased out of our product offering. To help you transition from these older air cleaner designs to newer designs with improved filtration technology, the upgrade tables below will guide you to a newer air cleaner housing (or family) that is a close match to the older model. See the service parts section for available parts for older air cleaner housings. If you need help to upgrade, contact Donaldson. See back cover for contact information.

## Upgrade paths for FHG, FWG, FPG, and FRG, to PowerPleat™ or PowerCore®

Older FHG	FPG Model	--- FRG Model --- Style A	--- FRG Model --- Style B	PowerPleat	PSD
G052558	G065424	G052686			
G052559	G065424	G052686			
G052560	G057511	G052685		G052742	
G052561	G057511	G052685		G052742	
G065104	G070019	G065551			
G065113	G065432	G065541			
G065212	G065432	G065541			
G065360	G065432	G065551			
G080147	G070019	G080582			
G080195	G082528	G080585			
G080200	G082527	G080582			
G080490	G082527	G080582			
G090022	G090225	G090245	G100297		
G090024	G090225	G090250	G110206	G110474	D090073
G090182	G090225	G090245	G100297		
G090183	G090225	G090250	G100297		
G100035	G100319	G100398	G110206	G110474	D090073
G100036	G100319	G100395	G100297		
G120012		G120417	G110206	G110474	D090073
G120014		G120415	G110206	G110474	D090073
G120036		G120415	G110206	G110474	D090073
G120037		G120417	G110206	G110474	D090073
G140022		G140523	G130097	G130373	D100031
G140054		G140523	G130097	G130373	D100031
G140055		G140526	G130097	G130373	D100031
G160078		G160679	G150092		

Older FWG	FPG	FRG	PowerPleat	PSD
G042503	G042544			
G042529	G042544			
G052510	G057511		G052742	
G052512	G057511		G052742	
G065266	G070017			
G080023	G082528			
G080026	G082528			
G120365		G100297		
G100003		G100297		
G100004		G100297		
G120059		G110206	G110474	D090073
G120063		G110206	G110474	D090073
G140077		G130097	G130373	D100031
G140083		G130097	G130373	D100031
G160104		G150092		
G160107		G150092		

## Upgrade SRG to SSG for easier maintenance



Replacing an older SRG housing with the new SSG housing allows you to simplify your routine filter service — no more separate gaskets at each filter change or removing a bolted on cover. SSG filters have RadialSeal™ end caps that provide a more reliable, consistent seal. Choose from an upper assembly conversion kit or you may want to install a complete new housing if your current SRG assembly needs repair or is reaching the end of its useful life.



**SRG29 Housing**



**Upper Body Conversion Kit**



**SSG29 Housing**



### Kit Order Information

SRG Housing Item No.	SRG to SSG Kit* Kit No.	SSG Housing Item No.
G200008	X009702	G200087
G200013	X009701	G200086
G290000	X009230	G290057
G290023	X009230	G290052
G290012	X009231	G290053

\* The finish on the replacement kit upper assembly is a white, powdered-coated paint. Installation instructions are included with the kit.

Note: Extra lead time may be required for processing and shipping.

Donaldson provides this technical reference as a collection for those who want to gain a better understanding of air filtration for engines.

Good filtration needs to be an integral part of the system to ensure the long life and proper operation of the vehicle and engine components. Today diesel engines are very sophisticated with many precision systems working together. These systems require optimum filtration to ensure their performance.

## Section

Airflow Direction for Donaldson Air Cleaners .....	242
<b>Shoptalk:</b> Best Practices, Service, Facts and Tips .....	247
Air Restriction & Affects of Elbows and Entrance Diameters. ....	257
Terms & Definitions .....	259
Filtration and Separation Mechanisms .....	260
Filter Media used in Air Filtration .....	261
Filter Efficiency .....	265
Filter Cleaning.....	266
Safety / Secondary Filter .....	267
Installation Guidelines for STB Strata™ System .....	268
Frequently Asked Questions.....	269
Off-road Case Study — PowerCore® Air Cleaner.....	272
Technical Paper — PowerCore® Filtration Technology .....	274
Technical Paper — Spiracle™ Crankcase Filtration .....	279
Application Design Worksheets — Engine Air .....	285
Application Design Worksheet — Crankcase Filtration .....	287



Donaldson has air cleaner housings that work in a variety of dust conditions and air flow patterns (A – D and G).

For improved filtration reliability and quicker filter service compared to older axial seal style air cleaners, Donaldson recommends installing either PowerCore® air cleaners or housings with RadialSeal™ sealing technology, whenever possible.

### Flow Direction Legend

Description	Part No. Example
<b>A</b> = Air in the End, Out the Side	<b>A</b> 042511, <b>A</b> 112018
<b>B</b> = Air in the Side, Out the End	<b>B</b> 045008, <b>B</b> 120271
<b>C</b> = Air in the End, Out the Same End	<b>C</b> 080025, <b>C</b> 065003
<b>D</b> = Air in the End, Out the Opposite End	<b>D</b> 100030, <b>D</b> 055004
<b>G</b> = Air in the Side, Out the End	<b>G</b> 290010, <b>G</b> 110214

### Standard & Reverse Flow Filters

These filters look exactly the same except there are dark lines viewable on the filter media of one of the filters. What's different? One is a standard flow filter, the other reverse flow. They fit housings that have specific flow requirements and are not interchangeable even though they look like they could be.

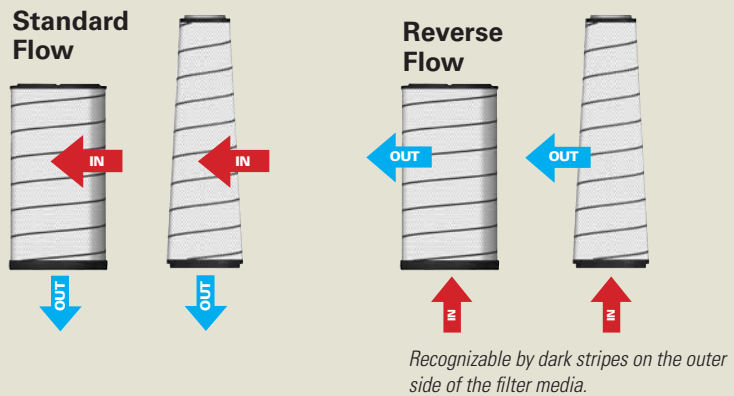

AIR FILTRATION TECHNICAL REFERENCE

## **A** Air in the End, Out the Side (reverse flow filters)

### Light Dust — ERA

Classic cylindrical design, black finish, cowl-mounted for vertical installation. Airflows to 1350 cfm. *Page 58*

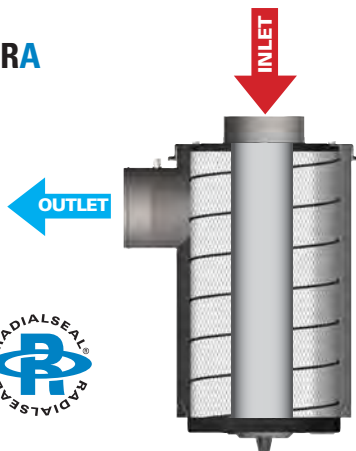

### Light Dust — EBA Konepac™

Same housing as original EBA but with cone shaped filter (Konepac), can be mounted either horizontally or vertically. Airflows to 1850 cfm. *Page 63*

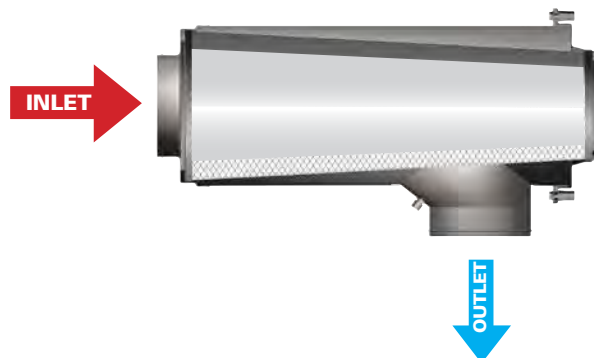

**FLOW**

**B**

**Air in the Side, out the End** (standard flow filters)

**Medium Dust — XRB**

The RadialSeal, plastic, two-stage air cleaner with side inlet for horizontal installation. Body diameters in 8", 10" and 12". Handles airflows of 265-630 cfm. Mount under hood or behind cab. *Page 88*

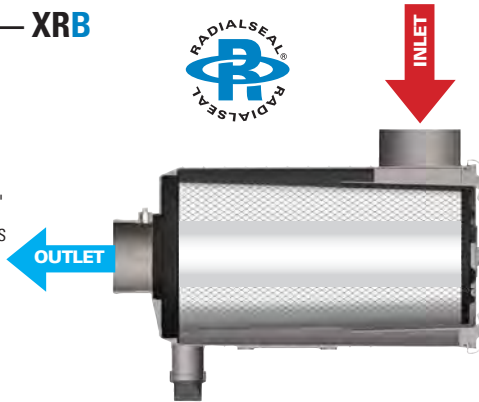

**Light and Medium Dust — FKB**

A compact housing high dust holding capacity and comparable airflow to FPG. Two-stage filtration, side inlet, horizontal installation. Body diameters in 4", 5" and 6". Mount under hood or behind cab. Handles airflows from 70–207 cfm. *Page 80*

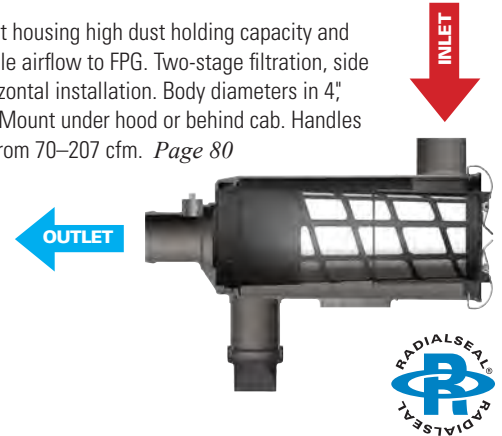

**Light Dust — EBB**

A small housing with higher dust holding capacity and comparable airflow. Side inlet, horizontal installation. Airflows to 1640 cfm. *Page 74*

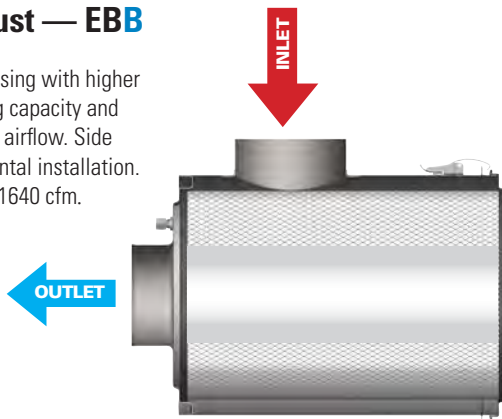

**Light Dust — ECB**

Disposable, small, lightweight and unitized (housing and filter in one). For high-vibration engines. Can be vertically or horizontally mounted. Airflows to 2118 cfm. *Page 46*

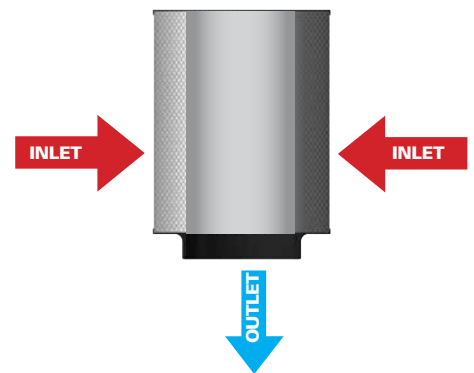

**FLOW** **C**

**Air in and out the Same End** (standard flow filters)

**Light Dust — ECC**

Disposable, small, lightweight and unitized (housing and filter in one). For high-vibration engines. Can be vertically or horizontally mounted. Airflows to 760 cfm.  
*Page 46*

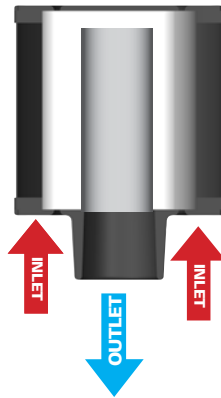

**FLOW** **D**

**Air in the End, out Opposite End**

**Medium to Heavy Dust — PSD**

**PowerCore**  
A Donaldson Filtration Technology

PSD units are small and compact with built-in mounting brackets. Can be vertically or horizontally mounted. Airflows to 1252 cfm.  
*Page 32*

**Light Dust — ECD**

Disposable, small, lightweight and unitized (housing and filter in one). For high-vibration engines. Can be vertically or horizontally mounted. Airflows to 185 cfm.  
*Page 46*



**Light Dust — PCD**

**PowerCore**  
A Donaldson Filtration Technology

PCD units are small and compact with built-in mounting brackets. Can be vertically or horizontally mounted. Does not have an integrated pre-cleaner. Airflows to 974 cfm.  
*Page 32*

**FLOW**

**G**

**Air in the Side, Out the End** (standard flow filters)

**Light Dust — EPG**

Single stage filtration. Smaller than ECG and lightweight, sturdy, and totally plastic. Horizontal installation. Airflows to 1325 cfm. *Page 52*

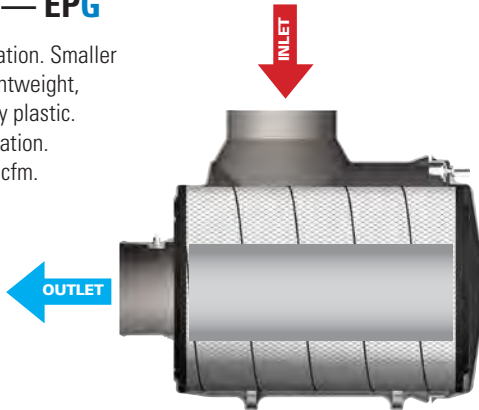

**Light Dust — ECG Konepac™**

Second generation Konepac with a cone-shaped filter has a long and narrow housing. Designed for horizontal installation; usually mounted under hood or behind cab. Airflows to 1600 cfm. *Page 68*

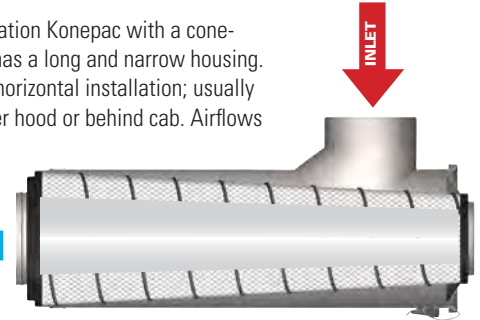

**Medium Dust — FPG**

The first fully plastic air cleaner in our two-stage filtration line. Tangential inlet, with or without safety element, body diameters from 4" to 8". Handles airflows of 55-346 cfm. Flexible mounting — horizontally, vertically or at an angle. *Page 96*

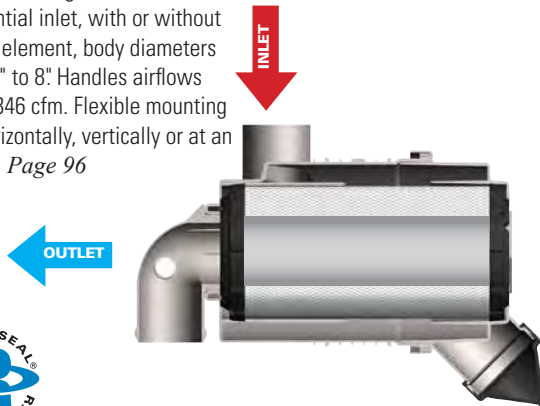

**Medium Dust — FVG**

A heavy-duty housing, our FVG has high airflow throughput and safety filter. Adds a vane in the inlet for a more aggressive first stage of cleaning. Horizontal mounting required. Airflows of 690-1200 cfm. *Page 126*

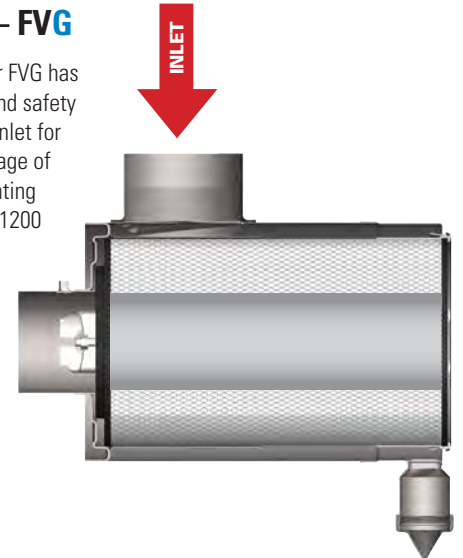

**Medium Dust — PowerPleat 05**

All plastic, two-stage air cleaner. Tangential inlet, with or without safety element, body diameter of 5". Handles airflows up to 95 cfm. Available in 90° or straight outlet. *Page 96*

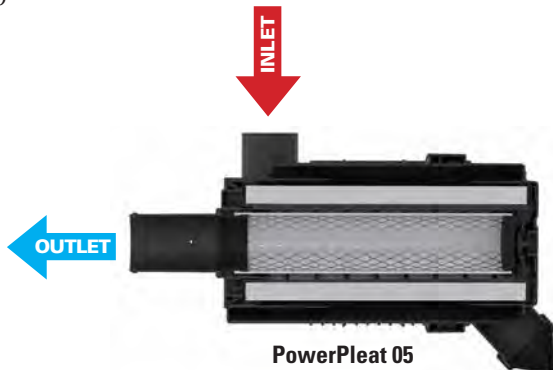

**Medium Dust — PowerPleat 11, 13**

All plastic, two-stage air cleaner. Tangential inlet with body diameters of 11" and 13". The 11" handles airflows up to 437 and the 13" handles airflows up to 597 cfm. *Page 96*

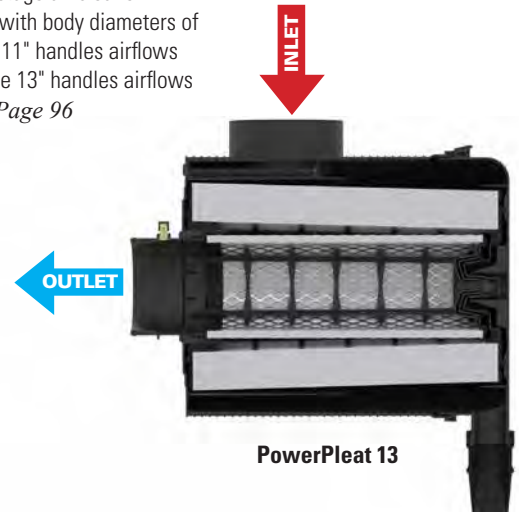



**FLOW**

**G**

**Air in the Side, Out the End** (standard flow filters)

**Medium to Heavy Dust — FRG**

This two-stage filtration housing is available in body diameters of 5" to 18". This style is the ideal upgrade from our older FWA, FWG, FHG and FTG housings. Horizontal mount required. Style A handles airflows up to 795 cfm and our new Style B handles airflows up to 1390 cfm.  
*Page 107*

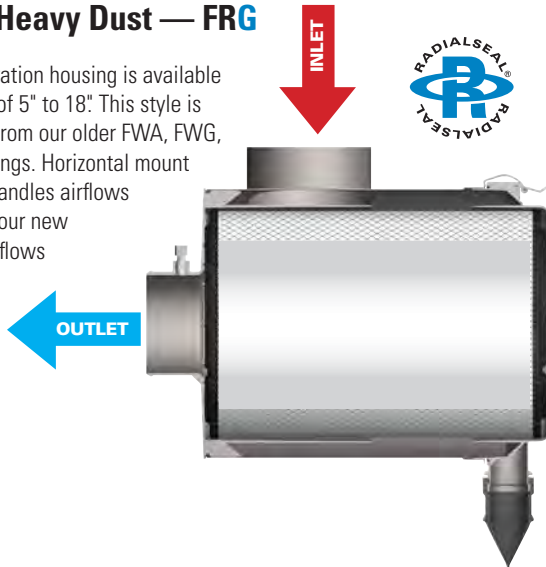

**Heavy Dust — FTG**

Two models available and designed for the engines on large equipment. Both have exact same airflow (from 1480-1870). Inlet tube position on housing body is only difference between the two models. *Page 121*

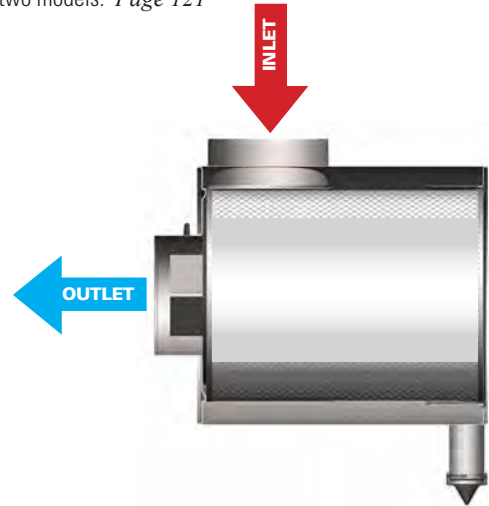

**Heavy (Severe) Dust — STG**

The efficient "T" design of the STG allows high airflow and strong two-stage filtration. Two styles available — one with a peripheral inlet and another with a tubular inlet. Handles airflows from 390-1760 cfm. Can be mounted vertically or horizontally.  
*Page 142*

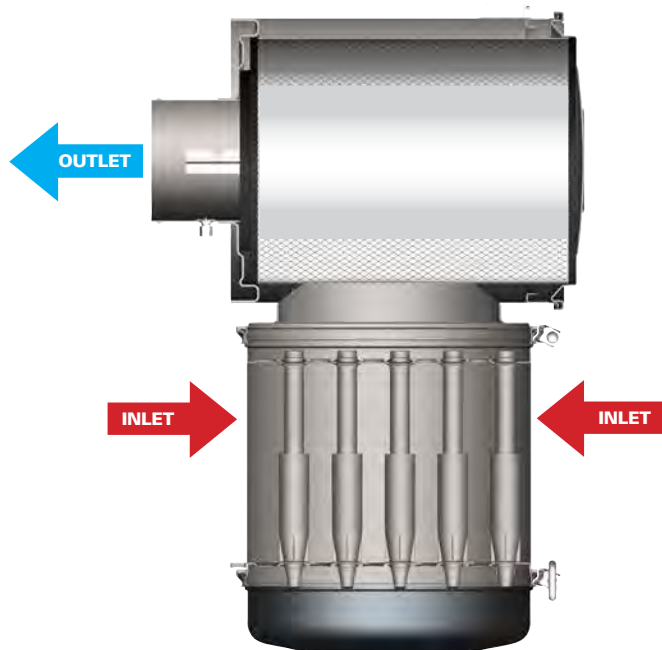

**Heavy (Severe) Dust — SSG**

These models replace our older SRG models. Donaldson's largest two-stage engine air cleaner, designed for the engines on large equipment. Handles airflows up to 4800 cfm per air cleaner. Multiple units can be used on very large equipment. The best protection for 500 to 3000+ horsepower diesel engines. This model uses RadialSeal™ sealing technology for filter retention.  
*Page 132*

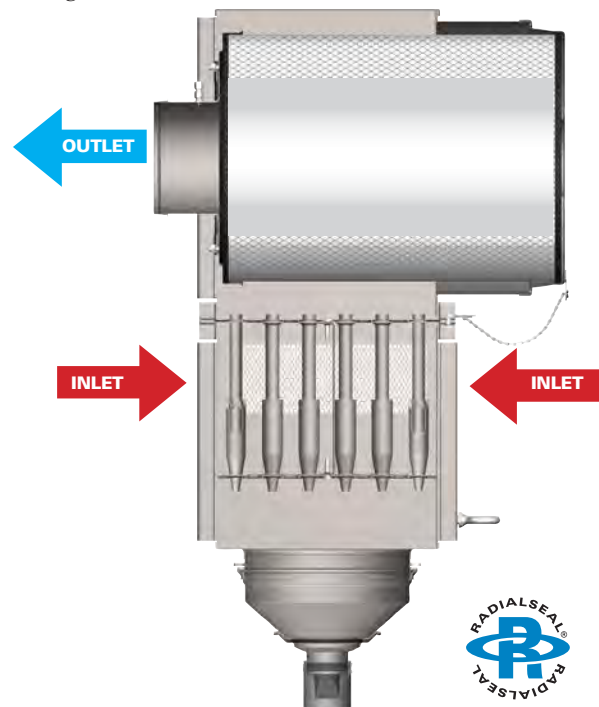

AIR FILTRATION TECHNICAL REFERENCE

# Simple Facts for Owners of Diesel-Powered Equipment

The following **Shoptalk** section contains maintenance tips, cost reduction ideas, and product features and benefits.



## Shoptalk Index

Air Filtration — Best Practices .....	248
Don't remove an air filter from its housing simply to inspect it .....	248
Ideally, service your air filter by restriction measurement or follow your regular maintenance schedule .....	248
Never hit a filter to try cleaning it.....	248
Do not clean a primary or safety filter instead of replacing it.....	248
Never operate a system with only a safety filter in place .....	248
For longer service between filter changes, consider upgrading to an extended service filter .....	248
Don't use a dented or damaged filter .....	248
Check any intake hoods and pre-cleaner devices during maintenance routines .....	249
Do not judge the filter's remaining life by looking at it.....	249
Never leave an air cleaner open longer than necessary.....	249
Don't ignore a worn or damaged gasket .....	249
At filter change-out, check to ensure that there is no damage to the air cleaner housing itself .....	249
Check for any air leaks in the ducting on both sides of the air cleaner.....	249
Don't take chances with weather-worn Vacuator™ Valves .....	249
Never substitute one filter with another one that has a different model number.....	250
A water manometer is the most accurate method to verify airflow restriction.....	250
Installing RadialSeal™ filters .....	250
Filter service & maintenance records .....	250
Avoid, cross contamination during filter service .....	250
Inspect the entire air induction system.....	250
Filter Storage & Handling.....	251
Air Filtration Pictogram .....	251
Take a Look at Filter Efficiency and Dust Handling .....	252
All Nanofibers are NOT Created Equally .....	252
Don't Throw Out a Good Filter Just Because it Looks Dirty ....	253
Will Using Aftermarket Filters or Mufflers Void My Warranty?.....	254
Worried About Water in Your Air Intake System? .....	254
Keep Those ECG Konepac™ Air Cleaner Latches Inspected.....	255
No Matter What Dust Condition, Pre-cleaners Extend Air Filter Life .....	255
Did You Know that Your Truck, Tractor, and Airplane Can All Use Donaldson Filters? .....	256
Donaldson Keeps Military Vehicles Moving.....	256

### Air Filter Service — Best Practices

Here are some dos and don'ts from Donaldson about air filter servicing and handling. This servicing information is provided as a best practices guide. It is not however intended to replace or supersede the service instructions supplied by your engine or vehicle manufacturer.

#### Don't remove an air filter from its housing simply to inspect it.



- Removing and replacing the same filter can do more harm than good.
- Ridges of dirt on the gasket sealing surface can drop on the clean filter side when the gasket is released.

#### Never hit a filter to try cleaning it.

- Rapping hard enough to knock off dust damages the filter and can place your engine at risk for dust ingestion.
- Deeply embedded dirt is never released by tapping.
- It is always safer to keep operating until you can change to a new filter than to try and tap out the dirt.



#### Never operate a system with only a safety filter in place.

- Safety or secondary filters used alone will let harmful contaminant enter the engine.
- Safety or secondary air filters are designed to compliment the primary filtration or provide protection during primary filtration service.

For longer service between filter changes, consider upgrading to an extended service filter such as Donaldson Blue® air filters. Then service the filter by restriction only.



#### Ideally, service your air filter by restriction measurement or follow your regular maintenance schedule.

- If you don't trust your current filter service indicator, getting a new one is a good idea.
- Restriction indicators, mounted on the air cleaner system are recommended for keeping an eye on restriction levels and indicating when servicing is due.
- For testing of initial restriction and confirming remaining filter life, we recommend the greater accuracy of a clock-type restriction gauge or water manometer.



When the indicator window shows "RED," it's time to replace the air filter. A "GREEN" window indicates all is OK.

#### Do not clean a primary or safety filter instead of replacing it.

- Heavy-duty air filtration manufacturers do not recommend any type of cleaning process to be used on their products.
- Once an air filter has been cleaned or washed, the Donaldson filter warranty is no longer valid.
- The dirt holding capacity of a filter is reduced 20 – 40% with each cleaning attempt.
- There is also the real risk of dirt reaching the clean side of the filter if cleaning is attempted.
- The risk of filter damage from washing, tapping, high pressure water, or compressed air cleaning is very real.
- The potential savings from risky attempts at filter cleaning won't come close to offsetting potential damage to engine components.
- Increased engine wear and damage is the result of the ingress of contaminant over time.

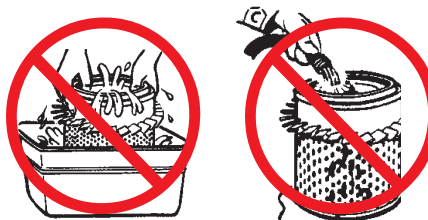

#### Don't use a dented or damaged filter.



AIR FILTRATION TECHNICAL REFERENCE



### Tips and Maintenance Practices for Equipment Longevity!

#### Check any intake hoods and pre-cleaner devices during maintenance routines.

- A missing inlet hood will significantly shorten filter life. If your unit had a hood or pre-cleaner originally, make sure you replace it.
- Check openings and tubes on pre-cleaners to make sure they are not plugged
- Replace any units that are damaged. Damaged or dented units will not operate properly.



#### Never leave an air cleaner open longer than necessary. An open air cleaner with filter removed is a direct entry to the engine.

- Keep your engine protected during filter changes.
- Contaminants that are smaller than the eye can see can be damaging to an engine.
- If the air cleaner housing is not going to be reassembled immediately, be sure to cover the opening.



#### At filter change-out, check to ensure that there is no damage to the air cleaner housing itself.



#### Check for any air leaks in the ducting on both sides of the air cleaner.

An air leak between the air cleaner and the engine gives dirt a direct path into the engine.

#### Do not judge the filter's remaining life by looking at it. A dirty-looking filter may still have plenty of life left.

- On the other hand, a clean-looking filter can also be deceiving.
- You can't see the dirt that's embedded deep within the filter media, and carbon contamination may not be visible to the eye.
- One of the best options for lowest filter maintenance costs and best engine protection is to monitor air filter life with a restriction indicator.
- It's a low-cost and smart investment.



#### Don't ignore a worn or damaged gasket. If your air cleaner has a cover gasket, replace it with a new one when changing filters.

- Some air cleaners, such as the EBA and ERA models, specifically call for a new gasket with each filter change-out.
- Never reuse the old one. Replace it according to the service instructions.



#### Don't take chances with weather-worn Vacuator™ Valves which can admit dirt instead of expelling it.

- Replace any missing or damaged Vacuator Valves and any air cleaner fasteners.
- Make sure the valve is flexible and not inverted, damaged or plugged. Replace it if damaged or if it looks like any of these images. A damaged or missing Vacuator Valve will disrupt the designed flow of air through the air cleaner.



Both of these filters look ready for replacement, but neither have reached their final servicing point.

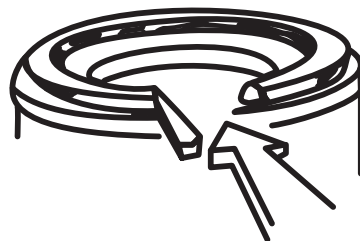



### More Tips and Maintenance Practices for Equipment Longevity!

#### Never substitute one filter with another one that has a different model number.

- The only exception is in cases where another filter is recommended as an upgrade to an older style filter.
- Filters may look almost identical, but even a small difference in size can prevent a good seal or affect airflow.
- Selecting a filter by fit alone may also give you the wrong media with potentially serious consequences for your engine over time.

#### A water manometer is the most accurate method to verify airflow restriction.

- For testing of initial restriction and confirming remaining filter life, we recommend the greater accuracy of a clock type restriction gauge or water manometer.
- Use the restriction tap provided on the air cleaner or at the transfer pipe.
- Replace the filter only when the restriction level has reached the maximum recommended by the engine or equipment manufacturer.
- Restriction indicators that are mounted on the air cleaner system are recommended for keeping an eye on restriction levels and indicating when servicing is due.



#### Installing RadialSeal™ filters

- Donaldson RadialSeal filters have a dry lubricant on the seal which aids in installation and removal. Do not remove the lubricant.
- No cover pressure is required to hold the seal in place and one should NEVER use the service cover to apply pressure.
- Forcing a cover could damage the housing, filter and fasteners and void the warranty.
- If the service cover presses against the filter before the cover is fully in place, remove the cover, push the filter further into the air cleaner by hand and then the cover will go on with no extra force.



#### Filter service & maintenance records

- Vehicle and engine manufacturers provide filter maintenance practices for the equipment they sell. Make sure to follow their recommendations for routine filter service. Being able to show/reveal your maintenance records for potential warranty claims is essential.
- Like all components, air intake systems have evolved and older styles and filters have different maintenance procedures. Make sure your maintenance personnel are familiar with the proper service techniques.
- Log or track your filter changes. Whether you are going to service by miles, hours or restriction.
- Many maintenance shops find it helpful to record the date of filter change directly on the filter.
- If you have to replace an entire air cleaner housing, consider designs that offer improved filtration performance (high efficiency filtration) or enhanced sealing (Donaldson RadialSeal™ housings).



#### Avoid cross contamination during filter service.

When a dirty filter is at its service point — the inlet side of the filter is loaded with contaminant — take these precautions to eliminate contaminant from getting on the outlet side of your new filter or clean sealing surfaces (gaskets or RadialSeal™ end caps).

- If you wear gloves during service, remove them prior to handling the new filter.
- If you don't use gloves, wash or clean your hands before handling the new filter.
- Keep your new filter in its box until you're ready to replace.
- If product box has layers of contaminant, take care that the contaminant doesn't get on the new filter as you remove it from the box.



*The clean side of your air filter can vary depending on the application. Some filters load on the outer surface (shown above — referred to as standard flow), and some load on the inside surfaces of the filter (referred to as reverse flow).*

#### Inspect the entire air induction system

The last step to any air filter service, is to inspect and tighten all air cleaner system connections.

- Immediately replace or repair any visible holes or damaged components.
- Inspect all air ducting for worn spots or damage — elbows, connections and seals.
- Check all clamps, making sure they're secure and tight.
- Inspect your pre-cleaners or inlet hoods (if equipped).
- Annual replacement of air cleaner system gaskets is recommended.
- Reset manual filter indicators.
- Record action items taken in your filter service records.



## Tips and Recommendations for Storage and Handling

Whether it's an empty trailer or building, it's important to practice good storage and handling techniques when it comes to filters. Before installing any filter on a piece of equipment make sure the filter is clean, unused and free of damage and is not more than six years old from the manufacturing date.

- Never store an air filter on a shelf without it being in a box or totally sealed from outside contaminant.
- When you see an open box of filters on the shelf, tape it shut — unless the filters inside the box are individually sealed.
- Handle filters with care to prevent filter damage; for example, don't throw filters into the back of a truck.
- If transporting filters from one job site to another, don't let them roll around on the floorboard or in the back of the truck, as this may cause damage.
- Metal storage shelves may cause condensation to form on filters if sitting directly on metal. Over time the filter may get rusty. This is another good reason to store filters in boxes.
- If the product box has layers of contaminant, take care that the contaminant doesn't get on the new filter when you remove it from the box.
- Practice "first-in, first-out" with your inventory. When possible, always use the oldest inventory first.
- Make sure any labels with product information and manufacturing dates are visible to personnel pulling from the shelves.
- The conditions under which the filters are stored can have a significant impact upon the shelf life of the filter; e.g., conditions of excessive temperatures or exposures to certain chemical environments can have an adverse effect on shelf life.
- Avoid cross contamination from an old filter to a new one. Make sure your hands are clean when handling the new filter and avoid touching/handling the outlet side of the filter.

### Air Filter/Air Cleaner Pictogram

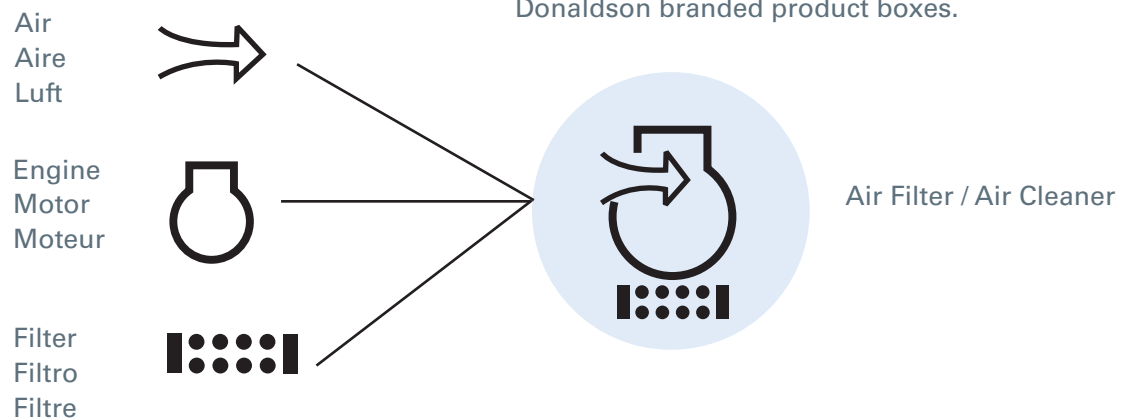

The Donaldson pictogram for air filters and housings is a combination of three industry shapes. You'll also see the pictogram on Donaldson branded product boxes.

### Take a Look at Air Filtration Efficiency and Dust Holding Capacity

Compare for yourself — see how much dust can pass through your air filter during 100 hours of operation.

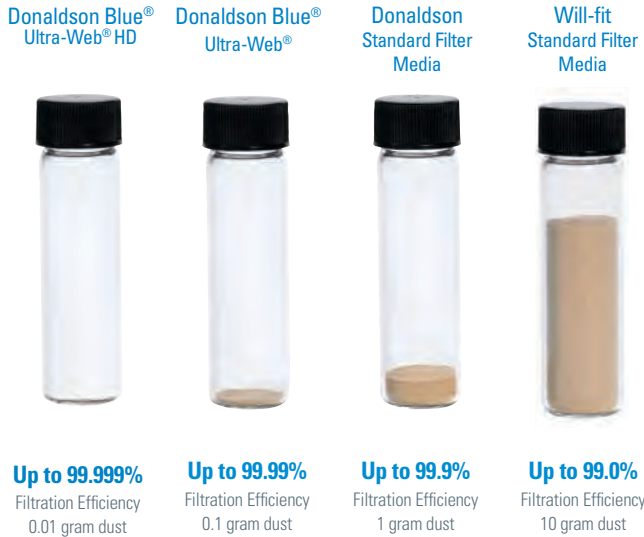

#### You Can See the Difference!

These dust vials show the actual amount of Arizona fine test dust that passes through the air filter media for every one kilogram of dust fed to the air filter, which is equivalent to 100 hours\* of equipment operation.

Will-fit filters can allow up to 100 times more dirt to pass through the filter into the engine than Donaldson Blue air filters with Ultra-Web filter media.

\* Estimate based upon typical medium dust operating conditions with 92% pre-cleaner efficiency. Actual results may vary.

#### Donaldson Ultra-Web® and Ultra-Web® HD fine fiber filtration technology delivers cost-saving benefits:

- Superior filtration
- Long filter life with submicron contaminant
- Highest efficiency
- Ideal for extended maintenance intervals
- Longer engine life

#### Don't leave engine protection to chance!

Use Donaldson Blue air filters with either Ultra-Web fine fiber media or Ultra-Web HD ultra-fine fiber media for maximum filtration efficiency and superior dust holding capacity.

### All Nanofibers are Not Created Equal

Since Donaldson introduced Ultra-Web® to industrial applications nearly 30 years ago and to the diesel engine market almost 20 years ago, the technology has been continually advanced and perfected to deliver longer filter life and higher efficiency while protecting the environment.

Ultra-Web and Ultra-Web HD fine fiber filtration technologies strike just the right balance between the strength of the fiber density of the web and the level of filtration. Donaldson fine fibers produce a very fine, continuous fiber that form a permanent web-like net that traps dust on the surface of the filter media.

#### Longer Filter Life

Ultra-Web technology is proven and perfected to last up to two times longer than Axial filters. What's the secret? Ultra-Web technology keeps particulate on the surface of the media.



Filtration scientists attribute surface loading of dust with lower operating pressure drop over a much longer period of time. This means less energy is required to pulse off the dust and allows the filter to perform longer. Conversely with other

types of filters, pressure drop starts higher and continues to rise quickly, which shortens the life of the filter and uses more energy.

#### Donaldson Nanofiber Technology

Donaldson Blue® Ultra-Web®

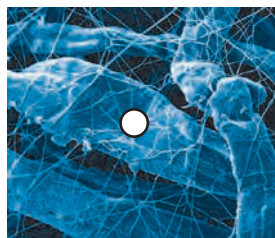

Donaldson Blue® Ultra-Web® HD

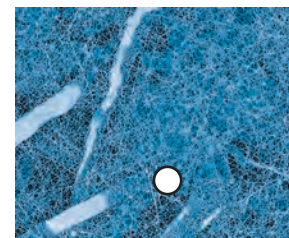

Standard Cellulose



○ = 10 micron particulate at 1000x enlargement.



## Don't Throw Away a Good Filter Just Because it Looks "Dirty"



Although this air filter may look "dirty" — it can go plenty more miles. Installation of a restriction indicator can save you money and time.

### Why Service By Restriction?

Proper air cleaner servicing will result in maximum engine protection against the ravages of dust. Proper servicing can also save you time and money by increasing filter life and dust cleaning efficiency.

By using proper filter restriction measurement tools you will use the full life of the filter at maximum efficiency. **DON'T BE FOOLED** by filter appearance: it should look dirty.



The only way to determine when a filter is plugged or plugging is to measure the restriction on the system with the engine working at max airflow.

### Two of the most common air cleaner servicing problems are:

1. Over-servicing: the least efficient time in the life of the filter is when it is new. Filter elements increase in efficiency as dust builds up on the media.
2. Improper servicing: your engine is highly vulnerable to abrasive dust contaminants during the servicing process when the filter is removed from the housing. A leading cause of engine damage is due to careless servicing procedures.

### Choose Restriction Measurement Tools that Best Fit Your Applications

Donaldson offers a variety of restriction measuring devices that help you get maximum filter utilization. All measure restriction in inches of water vacuum. All are resistant to vibration, breakage, weather, corrosion, dust, and dirt to assure reliable filter restriction readings.



Restriction measurement tools are available in the following categories: Graduated Indicators, Single Position Indicators, Visual Indicator and Switch, Switch Only, Sensors, and LED Displays. Refer to page 196 for a complete listing of restriction measurement tools that now includes Filter Minder®.





## Will Using Aftermarket Filters or Mufflers Void My Warranty?

**Answer:** Good News! No need to worry about voiding your warranty — you can use aftermarket products! You still need to follow your manufacturer’s recommended maintenance practices, but your warranty is protected under the Magnuson-Moss Warranty Act. Information on the Magnuson-Moss Warranty Act is available at <https://www.ftc.gov/tips-advice/business-center/guidance/businesspersons-guide-federal-warranty-law#Magnuson-Moss>.

In addition, Donaldson warrants its aftermarket products against failure due to defects in materials and workmanship for the period specified under the Terms and Conditions for the particular product.

## Worried About Water in Your Air Intake System?



Sometimes you can’t help operating equipment in extreme moisture environments, but it’s good to know a few things to help keep your air intake system running at top efficiency.

### Typical Symptoms of Water Ingestion:

- High restriction indications
- Mud caked in the Vacuator™ Valve
- Wet, wavy air filter media
- System rust, corrosion and/or water damage
- Moisture-related environmental problems such as icing

### Simple Tips to Keep Water Out of Your System:

- Check and clear the VacValve daily
- Make sure the air cleaner cover and filter are installed properly
- Inspect air intake system for any leaks



**Caution: A water-soaked air filter will occasionally lock-up a restriction indicator!**

A restriction indicator’s “lock-up” restriction level is generally marked on the indicator itself. To check an indicator, remove it, wipe the base clean, then apply a small amount of vacuum. If the indicator locks up, it is okay. If not, replace the indicator.

**Warranty Coverage**  
Donaldson warrants its Aftermarket products against failure due to defects in materials and workmanship for the period specified under Terms and Conditions for the particular product. Donaldson's obligation under this warranty covers replacing the failed product, including transportation charges, only. If the Donaldson product failure is the sole and direct cause of damage to the equipment on which the product was properly installed, Donaldson will reimburse reasonable costs to restore before the failure. This warranty does not cover failure due to misapplication, misuse, abuse, neglect, rust through and corrosion (mufflers), improper installation, improper service practices or non-Donaldson approved modifications.

**Notification**  
Donaldson must be notified in writing of any claims covered by this warranty within one year of the date of failure. Donaldson, at its discretion, will either physically visit the site where the alleged failure has been found, or request that all parts (Donaldson and other relevant parts) be shipped prepaid to its General Office, in care of the Product Lab or as otherwise specified.

**Terms and Conditions**  
Warranty coverage begins on the date and mileage the product is purchased by the user and expires when the specified number of years or miles has passed, whichever occurs first.

The length of warranty for replacement products provided under Warranty coverage is the balance of the warranty period remaining on the product being replaced.

**Warranty Length by Product Type**

Filtration Products	Warranty from Date of Delivery to User
Liquid Filter Assemblies and Accessories	1 year
Air and Liquid Filters	1 year from in-service date or until first cleaned or serviced in any manner
Air Cleaner Housings and Accessories	1 year
TopSpin™ HD	1 year
Air/Oil Separators	Limited Lifetime Warranty
	(8 months / 1,000 hours from in-service date)
Exhaust Products	Warranty from Date of Delivery to User
Diesel Mufflers	4 years or 500,000 miles (800,000 km)
Vertical Installation	3 years or 500,000 miles (800,000 km)
Horizontal Installation	1 year
Gas Mufflers	8 years or 1,000,000 miles (1,600,000 km)
Silent Partner™ Exhaust Silencer	4 years or 500,000 miles (800,000 km)
Stainless Steel	1 year
Aluminized Steel	1 year
Exhaust Accessories	8 years or 1,000,000 miles (1,600,000 km)
Chrome Parts (peeling and blistering only)	1 year or 100,000 miles (160,000 km)
Flex Pipe	30 days
Long-Life Flex Pipe	1 year or 120,000 (200,000 km); on-highway use only

Donaldson Company, Inc.  
Minneapolis, MN  
[www.donaldson.com](http://www.donaldson.com)  
North America: 852-374-1374

Brochure No. F1996a ENG 01/15  
©2015 Donaldson Company, Inc. All rights reserved.  
Donaldson Company, Inc. reserves the right to change or discontinue any product or specification at any time and without notice. Please refer to the U.S.A.

AIR FILTRATION TECHNICAL REFERENCE

## Keep Those ECG Konepac™ Air Cleaner Latches Inspected

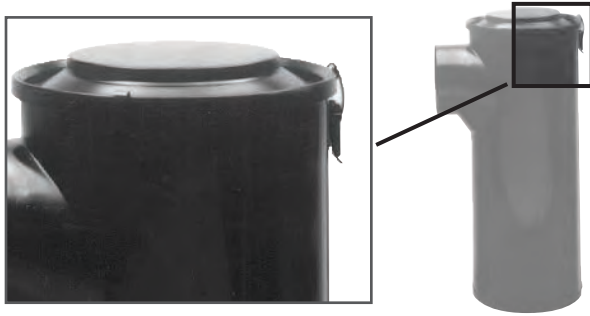

ECG style air cleaners have three cover latches that need to perform correctly to ensure the element gasket is sealing properly. These latches should be checked for tightness and wear. To check for tightness, close all three latches, then open and close them one at a time. There should be good tension and should snap tightly when closed. If any latches seem loose or rattle, they should be replaced.



The spring clip and pin repair kit is X009291 and fits all ECG style air cleaners.



The most obvious place to check for wear is the spring latch tip (the part that hooks into the notch on the filter cover). The tip may become sharp and cut into the filter cover with extended wear. The tip may also wear to the point where it will not hook onto the filter cover at all. If any of these conditions are evident, the latch should be replaced.

## No Matter What Dust Condition, Pre-cleaners Extend Air Filter Life



Six pre-cleaner styles offer the broadest product range in the industry

Pre-cleaners remove contaminant of varying sizes from entering the intake duct; they don't require any engine power to operate. Some devices collect the contaminant (Full-View), others just eject or drop the contaminant (TopSpin, Top Spin HD / in-line separator), or are connected via a scavenge system and route debris out the exhaust system (Donaspin / Strata Cap).

- Strata Cap and Donaspin are units for scavenge air system option for heavy dust condition operating environments. Additional components required for scavenge system (hoses, check valves, clamps and exhaust ejector)
- Pre-cleaners extend life of vehicle air filters and serve as rain caps
- Units are made of durable materials — either metal or impact resistant plastic
- Units install outside of engine compartment — leaving more space under hood for other components (exception-in-line separator)
- Pre-cleaners have no wires or power requirements
- Requires additional components for scavenge system (hoses, check valves, clamps and exhaust ejector)

### Quick Comparison

More characteristics about our pre-cleaner line. For more details, contact your local distributor or dealer.

Dust Condition	Max. Sepr Efficiency	Pre-Cleaner Family	Scavenge Required	Service Required	Material
Heavy	96%	Strata™ Cap	Yes	Yes	Plastic
	90%	Donaspin™	Yes	No	Steel
Medium	85%	TopSpin™	No	No	Plastic
	80%	TopSpin™ HD	No	No	Aluminum/ Stainless Steel
	70%	In-Line Separator	No	No	Steel
	75%	Full-View	No	Yes	Steel/Plastic

## Did You Know that Your Truck, Tractor, and Airplane Can All Use Donaldson Filters?



If you own or operate a Beechcraft, Piper, Cessna or Mooney airplane, or a Bell, Aerospatiale (Eurocopter) or MD Hughes rotorcraft, chances are it was delivered with Donaldson filters onboard. Airframe and engine manufacturers trust Donaldson quality. We've been providing superior pleated media engine air intake, fuel, lube and hydraulic filters for piston-powered aircraft for more than 40 years. When it comes time for your next maintenance check, don't compromise the integrity of your airplane! Ask your mechanic to install Donaldson OEM filters for maximum performance and filter life.



Donaldson General Aviation Engine Air Intake Filters

### Contact Information for Filtration Systems for the Aerospace & Defense Industry

North America 1-866-323-0394

Europe Aerospace +00 800-63-29-2750

Europe Defense +00 800-28-00-2900

For additional locations and contact information, visit:  
[www.donaldsonaerospace-defense.com](http://www.donaldsonaerospace-defense.com)

## Donaldson Keeps Military Vehicles Moving



The Bradley M2/A3 Fighting Vehicle relies on a Donaldson air cleaner and muffler.

### Did you know . . .

Donaldson designs and manufactures filtration and exhaust products for a large variety of defense applications and equipment? For example . . .



The LCAC Hovercraft uses Donaldson Strata™ panel filters to supply clean air to its engine.



Donaldson Defense Group introduced the Strata™ tube pre-cleaner on the Sikorsky CH-53 Helicopter.

We've designed filters to perform in extreme environments. Our filters are used worldwide in the roughest military applications, effectively filtering air and exhaust, as well as transmission fluid, hydraulic systems, lube oil, coolant, and fuel.



## What is Airflow Restriction?

The resistance to the flow of air through the air cleaner system; typically measured in inches of H<sub>2</sub>O or kPa.

Restriction across the air cleaner is the difference in static pressure between the atmosphere and the outlet side of the system being measured. *Analogy: trying to pull liquid through a straw that is kinked versus one that is not. Obviously, the greater the kink, the harder it is to move liquid through.*

Air in an intake pipe acts much the same way. Any time the direction of the air is changed, there is a resulting pressure that increases the restriction of the system. While we can't totally avoid direction changes, they should be minimized.

## Include Entire Airflow System When Calculating Initial Airflow Restriction

Any intake system design should incorporate the best protection at the lowest initial restriction possible. Because each intake component contributes to the total restriction of the system, it is recommended that the position of the air cleaner be as close to the engine as possible. It is also important to minimize the elbows, bends and long runs of duct work.

Changing the direction of the intake air movement causes restriction, which causes the engine to work harder. While this is something we like to avoid, the reality is that it cannot be avoided totally . . . but just how much is too much, and what can be done about it?

### Conversions:

1" H<sub>2</sub>O = 0.0361 psi = 0.249 kPa  
1 cfm = 0.0283 M<sup>3</sup>/minute  
1" = 25.4 mm  
1 lb-ft = 1.35 N•m

## The Affect of Elbows & Entrance Diameters on Air Cleaner System Restriction

Generally, the smoother the direction change, such as radiused tubes versus mitered bends, the lower the restriction. A 30° bend (figure 1) adds the least amount of restriction, while the 90° bend (figure 7) adds significantly more.

Remember that even straight pipe causes restriction and pipe with a cut-off blunt end will add much more than one with a flared inlet end. The slight flare makes a major difference in air turbulence, and consequently, in restriction.

Not only bends, but *length* of pipe is also a factor. For further details on the amount of restriction added to the system by piping and bends, see the next page.

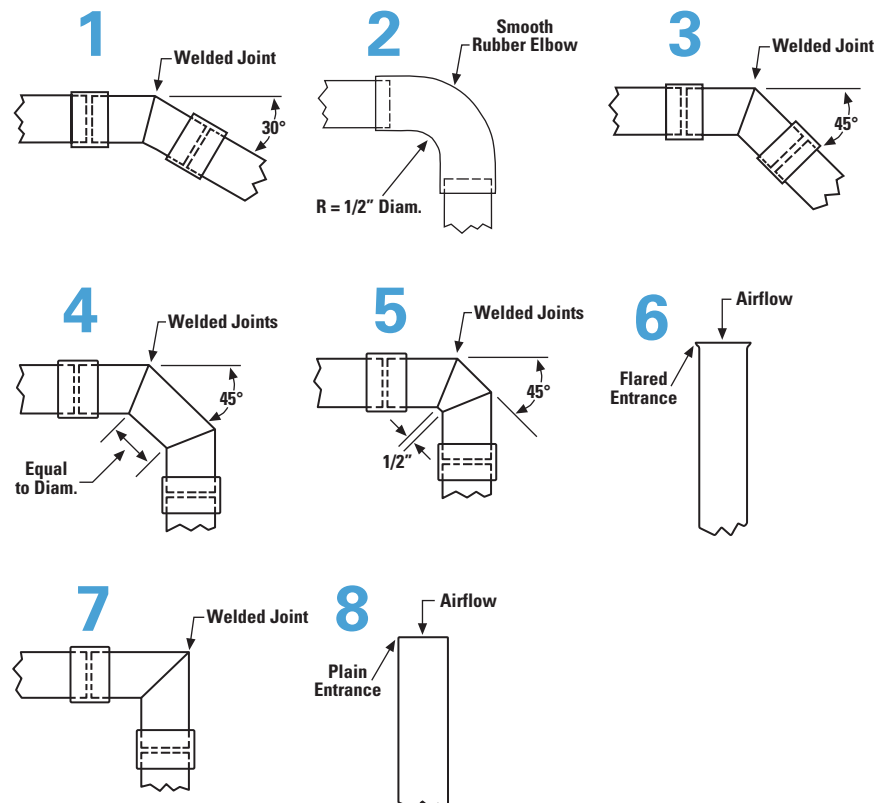



### The Goal: Minimize the number of bends AND use bends that cause the least amount of restriction

#### 4" Diameter Piping

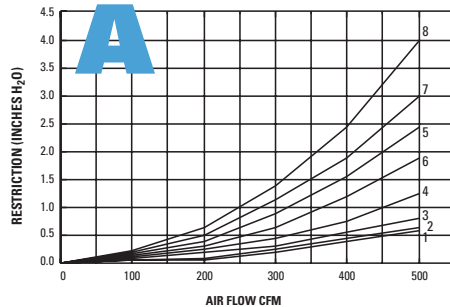

#### 5" Diameter Piping

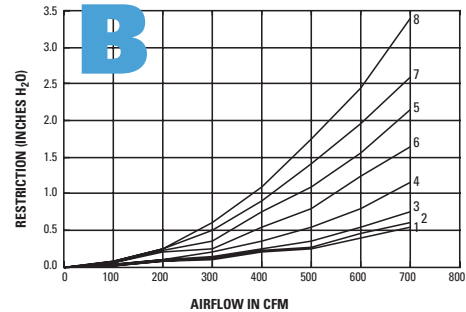

#### 6" Diameter Piping

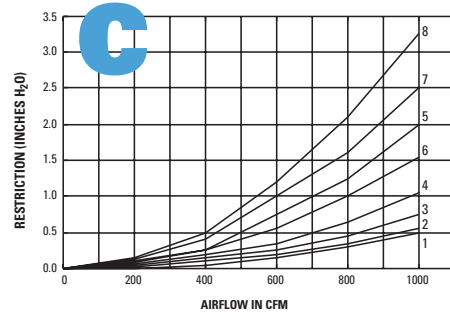

#### 7" & 8" Diameter Piping

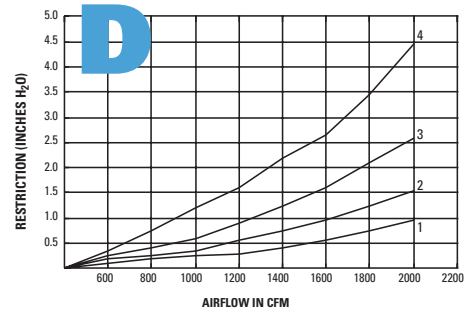

Graphs A, B, C, D and E show the amount of restriction of different piping diameters, with various types of bends (illustrations 1 – 8 as shown on opposite page), at various airflow levels. You will notice that the smoother the direction change, such as radiused tubes versus mitered bends, the lower the restriction. A 30° bend (shown in illustration 1) adds the least amount of restriction, while the 90° bend (shown in illustration 7) adds significantly more.

You may think it odd that straight pipe (shown in illustration 8) causes the highest amount of restriction. This is because of the blunt end. Compare the restriction curve to illustration 6, which shows a flared end. The slight flare makes a major difference in air turbulence, and consequently, in restriction.

Length of pipe is also a factor, as shown in graph E. Find the line that represents your pipe diameter at the airflow level you're running to give you a restriction figure for each foot of pipe length; then multiply by the length (in feet) of your plumbing and you have the amount of restriction added by that length of pipe. (See example below graph E.)

These curves should allow you to do a quick calculation on the plumbing you are planning for your system. Add this figure to the restriction of your air cleaner (and pre-cleaner when used) to know if your system is too restrictive for the engine. Many engine manufacturers specify restriction limits for new, "clean" engine air intake systems.

### Straight Piping of Various Diameters

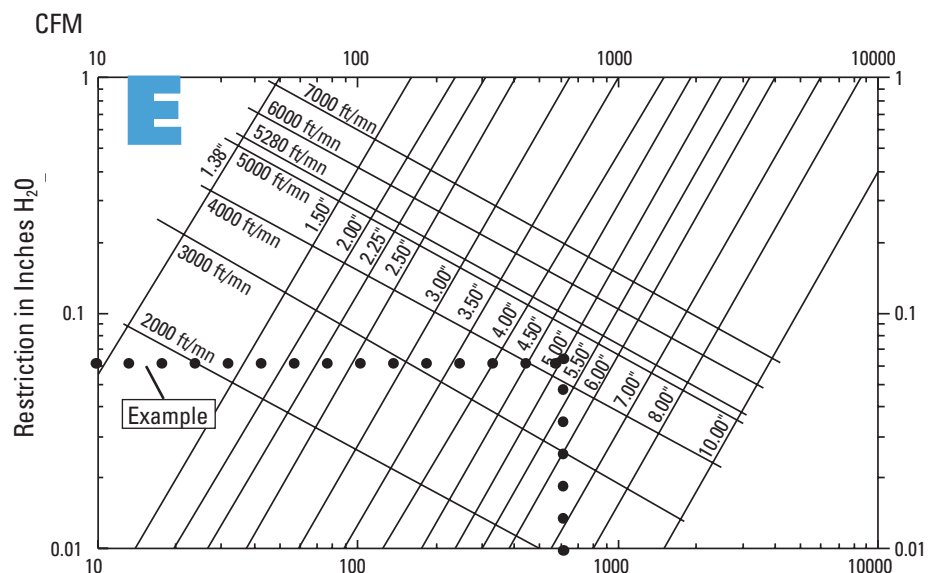

#### Example (Assuming a 600 cfm system with 5" piping)

1. At 600 cfm on horizontal axis, draw a line up to the 5" diameter line.
2. Draw a line from that intersection point over to the vertical axis to find the restriction point, in this case .06 H<sub>2</sub>O.
3. Calculate: .06 x 10 feet of piping = .6" H<sub>2</sub>O. This means that the 10 feet of 5" diameter piping add .6" H<sub>2</sub>O of restriction to the engine air intake system.

## Air Filter/ Air Cleaner

Device which removes particles suspended in the airflow as it is drawn into the engine.

## Airflow Requirements

Air is critical to the operation of an engine. The amount of air required by the engine depends on the type of engine, if it has a turbocharger, and the engine horsepower (kilowatt) rating. The engine airflow requirement or specification is set by the engine manufacturer. Airflow requirements from the engine manufacturer should be requested for any changes or upgrades made to the air system.

## Axial Seal

The axial seal sealing method requires a force between the air filter and air cleaner that provides enough compression on the gasket between the parts to create the seal.

## CFM

CFM means cubic feet per minute. This is the unit of airflow measurement. An engine requires a flow of air for combustion.

## Differential Pressure

Difference in static pressure measured immediately upstream and downstream of the unit under test.

## Dust Capacity

Dust capacity is the amount of contaminant that will be collected on a filter before a specified restriction level (set by the engine manufacturer) is reached.

## Dust Concentration

Dust concentration expresses the mass of dust in a specified volume of air. Typical ambient conditions are around 0.1 milligrams per cubic meter. Off-road conditions are around 100 milligrams per cubic meter.

## Filter Media

Filter media is the material in the filter that removes the contaminant. Filter media in primary filters is made from cellulose and various combinations and blends of fibers combined with resins to keep the fibers together.

## Manometer

A manometer is a device that can be used in-field for testing of a filter's initial restriction and confirming its remaining filter life. A manometer, or clock-type gauge, can be a more accurate method of restriction measurement.

## Overall Efficiency

Overall efficiency is the percentage of dust that the air cleaner with a filter removes from intake air. Donaldson air cleaners, with a Donaldson air filter, have a 99.99+% overall efficiency.

## Primary Filter

The primary filter is the filter in the air cleaner that removes around 99.9+% of the air's dust. The air flows through the primary filter first.

## RadialSeal™ Technology

RadialSeal refers to filter sealing technology that uses the urethane end cap and the cleaner's outlet tube to create the seal. This has become the preferred method of sealing over older axial seal designs.

## Rated AirFlow

Flow rate specified by the user or manufacturer; to be the maximum airflow required by the engine.

## Restriction

Restriction represents the resistance to the flow of air through the air cleaner system. The static pressure is measured immediately downstream of the unit under test.

Typical units are inches of water ("H<sub>2</sub>O) or kilopascal (kPa). Air cleaners with clean filters should have restrictions between 6-10"H<sub>2</sub>O or 0,5 and 4 kPa

- 1 H<sub>2</sub>O = 9,80665 Pa (Pascal)
- 1000 PA = 1 kPa (kilopascal)
- 100 Pa = 1mbar (milibar)
- 10 Pa = 1 daPa (decapascal)

## Restriction Tap

This is the point on an air cleaner where a port exists to add a filter service indicator. Air filter service indicators measure air restriction and trip or engage depending on the airflow pressure on the inlet side of the housing.

### Single-Stage Air Cleaner

A single-stage air cleaner is a dust removing system for intake air with a filter and no pre-cleaner.

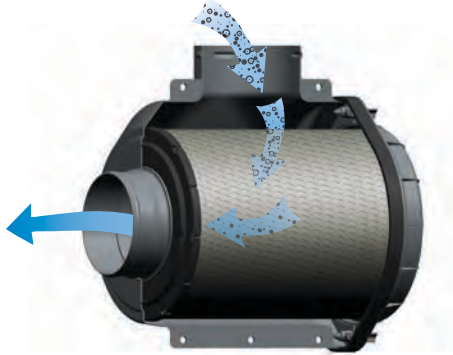

### Safety (Secondary) Filter

The safety (or secondary) filter is an optional filter that protects the engine during servicing of the primary filter and in case of a leak in the primary filter.

### Multi-Stage Air Cleaner

Air cleaner consisting of two or more stages, the first usually being a pre-cleaner followed by one or more filters. If two filters are employed, the first is called the primary filter and the second one is called the safety or secondary filter.



### Pre-cleaner

Device usually employing inertial or centrifugal means to remove a portion of contaminant prior to reaching the filter.



### Test Air Flow

Measure of quantity of air drawn through the air cleaner outlet per unit time. The flow rate shall be expressed in cubic meters per minute or cubic feet per minute (CFM).

## The Science of Air Filtration

### Filtration & Separation Mechanisms

Filtration and separation mechanisms are integrated into the design tools used by Donaldson personnel in the development cycle of new products.

#### Filtration Mechanisms

##### Primary

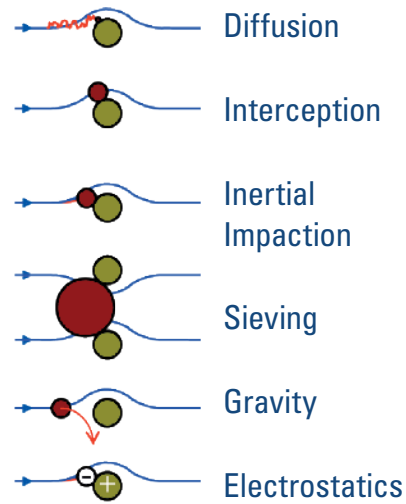

#### Separation Mechanisms

##### Primary

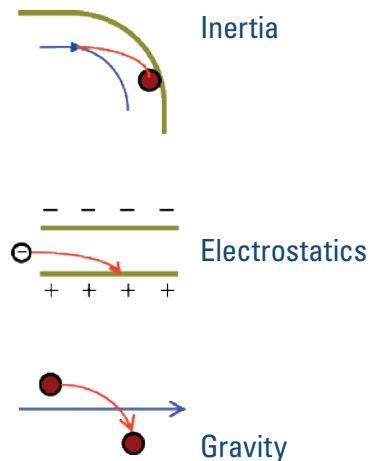

## Filter Media

Filtration media represents the central point of any filter design. Mastering this science is a key focus at Donaldson. While our users may not need to share this same level of understanding, some basics are always helpful. With the media representations below we hope to educate our customers on some of the more commonly used media types in this ever changing industry.

Today's engines are built to more stringent specifications and finer tolerances. Engine components require cleaner air to achieve better combustion and lower emissions. Your air intake system filter media and service practices can make the difference between engine power and engine problems.



### Cellulose (traditional media)

Primary dry filter media is a cellulose base material and used in the majority of our air filter applications. It is used primarily in two types of engine intake systems — single- or two-stage. Applications include off-road, on-highway trucks, buses, and underground mines.

#### How it Works

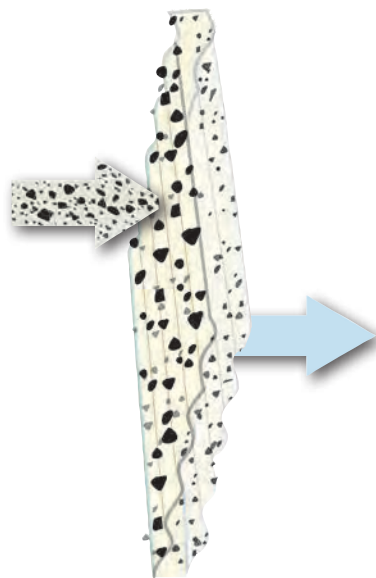

SEM 100x

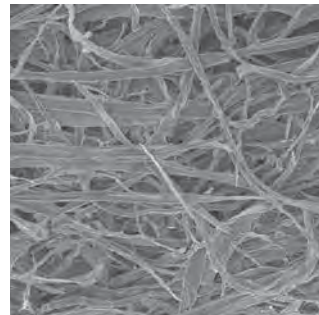

SEM 600x

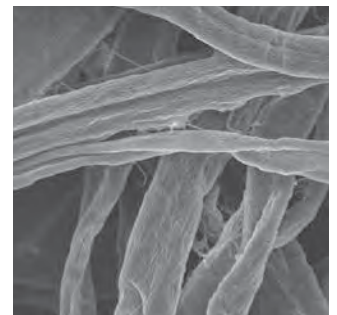

Media Image

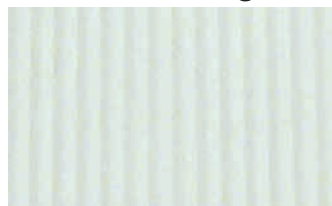



### Donaldson Blue® Ultra-Web® Nanofiber Technology

Ultra-Web® filter media is composed of a cellulose or a cellulose/synthetic substrate with nanofibers applied to one side. This media provides a durable filtration solution in the high temperature and humid environments experienced by diesel, turbine, hybrid, and other powered engines.

Ultra-Web offers a higher initial efficiency vs. standard cellulose, has very high efficiency throughout a filter's life, and provides excellent engine protection from sub-micron particulate (e.g. exhaust soot).

#### How it Works

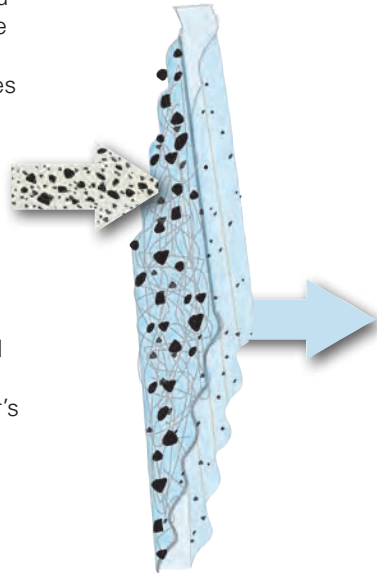

#### SEM 100x

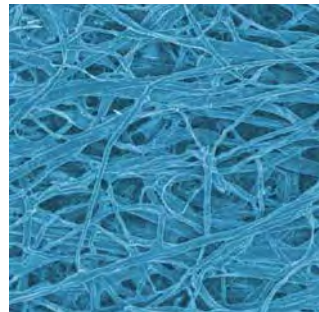

#### SEM 600x

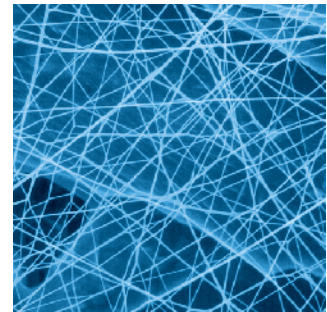

#### Media Image



### Donaldson Blue® Ultra-Web® HD Nanofiber Technology

While traditional Ultra-Web® media will protect your equipment in harsh environments, Ultra-Web® HD has been developed for use in extreme fine dust environments. It's the nano-technology that makes this filter such a strong performer.

Donaldson's Ultra-Web® HD media creates consistent inter-fiber spacing at a microscopic level. Because these fibers are so small and strong, we can add more of them to the critical ultra-fine fiber layer without creating additional restriction. The result is a filter that delivers everything required to combat dust ingress, providing ultra-long life and ultra-high efficiency.

#### How it Works

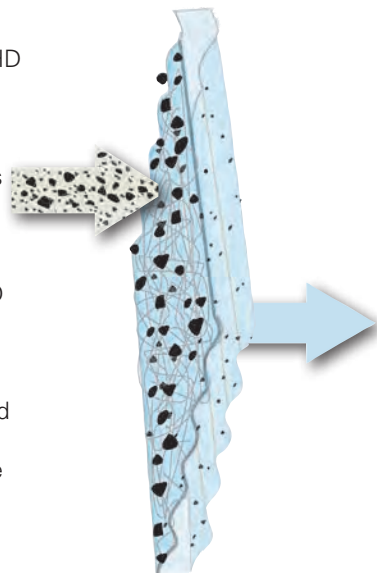

#### SEM 1000x

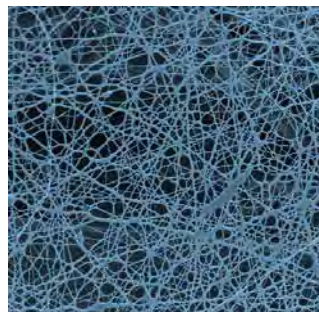

#### SEM 5000x

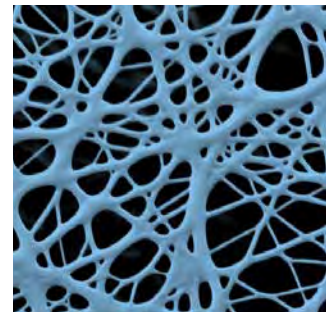

#### Media Image

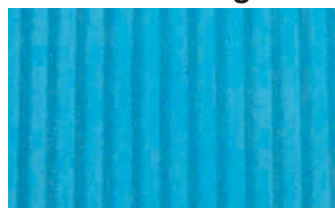

AIR FILTRATION TECHNICAL REFERENCE

### Vibration Resistant Media

Vibration resistant filter media is a cellulose base material that offers maximum filtration protection and withstands high pulsation/vibration situations that would normally destroy other filter medias.

Applications include, but are not limited to, one, two and three cylinder engines and piston compressors.

#### How it Works

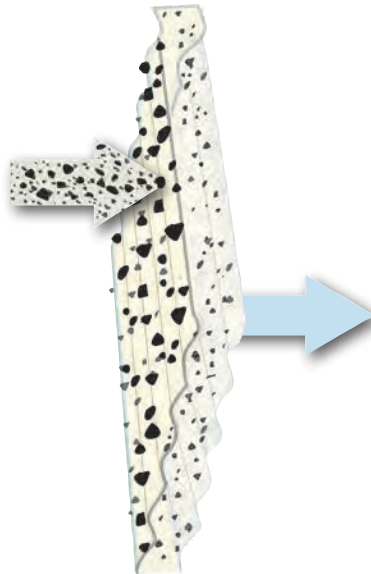

**SEM 100x**

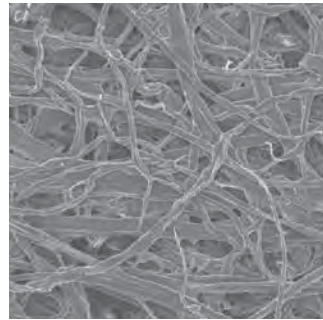

**SEM 600x**

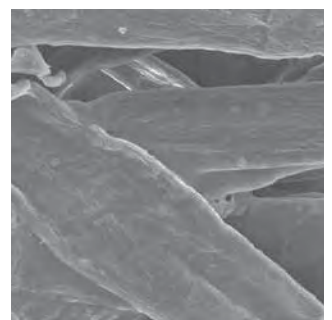

**Media Image**

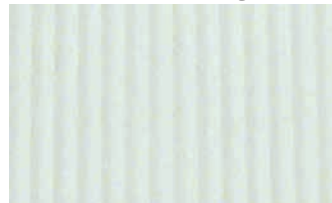

### Flame Retardant, UL-approved Media

Flame retardant/UL-approved filter media is a cellulose base material specially treated for use on vehicles operating in industrial applications where sparks or flames from backfiring through the intake system create a fire hazard.

Grain elevators and warehouses are good examples of UL-approved filter media applications.

#### How it Works

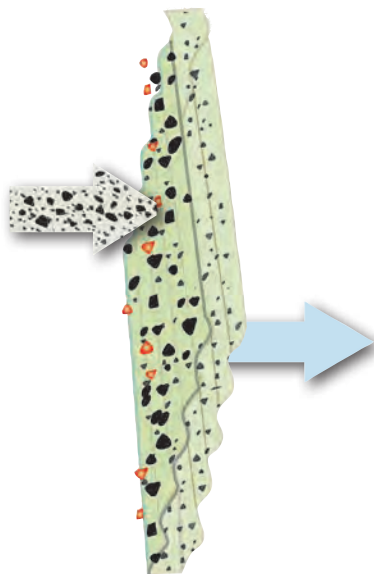

**SEM 100x**

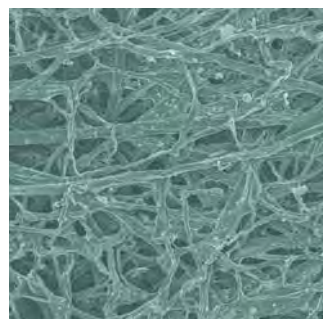

**SEM 600x**



**Media Image**

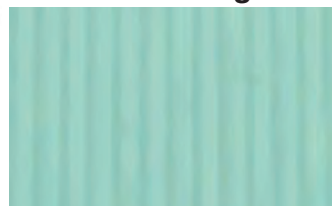

### Safety Filter Media

Pleated safety filter media is designed for heavy duty air cleaner systems with high velocity airflow and is used in safety filters — both single- and two-stage air cleaner systems. The safety filter protects the intake system while servicing the primary filter and in the event the primary filter is damaged.

The same media may be used for ventilation panel filters to remove dust, chaff and pollen from air entering vehicle cabs in construction, agricultural, industrial and mining applications.

#### How it Works

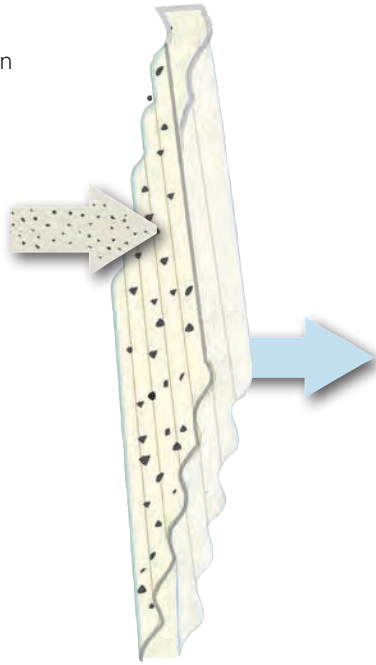

SEM 100x

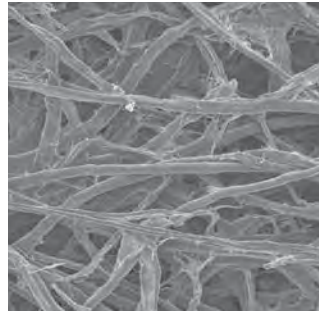

SEM 600x

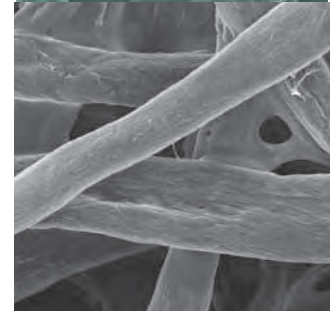

Media Image



Non-pleated safety filter media has a synthetic base. It is primarily used in light to medium duty intake system two-stage air cleaners, e.g., Donaldson F Series or Cyclopac™ type air cleaners. The safety filter protects the intake system while servicing the primary filter and in the event the primary filter is damaged.

#### How it Works

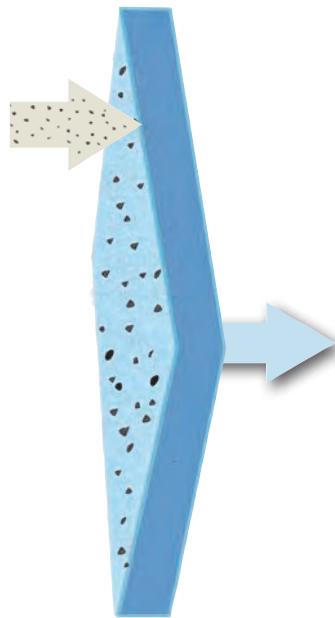

SEM 100x

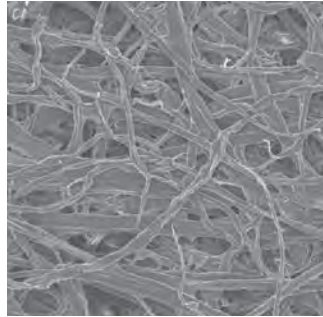

SEM 600x



Media Image





**Filter Efficiency:** Donaldson air filters in Donaldson air cleaner housings have a 99.9+% minimum overall efficiency.

Questions often arise about the micron ratings and test procedures on air cleaners and replacement air filters. Typically, air cleaners and air filters are not assigned a “micron rating.” Micron rating is a term used in liquid filtration. Air filters are evaluated for life and efficiency using an industry-wide standard (ISO 5011). The following should clarify the questions surrounding this issue.

Filter life is measured in total grams fed or in hours of lab life and is determined by testing at a standard test dust concentration of 1 g/m<sup>3</sup> (0.028 g/ft<sup>3</sup>) for single stage air cleaners or 2 g/m<sup>3</sup> (0.056 g/ft<sup>3</sup>) for multistage units at either a constant or variable airflow. The end of the life testing is determined using the restriction method. When the predetermined restriction service point is reached, the test is stopped and the filter is weighed. The amount of test dust held by the filter is considered the capacity or life of the filter. The life of an air cleaner requires some additional consideration. Many air cleaners have inertial separators included in the housing. These inertial separators remove up to 98% of the dust that is fed during one of these tests. Therefore, the inertial separator efficiency must also be evaluated.

Filter efficiency is calculated by determining the increase in weight of an absolute filter (an absolute filter captures any dust that passes the test filter) located downstream of the test filter versus the weight of the total dust fed.

Table 1 details the particle size distribution of the standard test dust used for life and efficiency evaluations (ref. ISO 12103-1).

Table 2 lists common contaminants found in field environments, as well as their particle size ranges. Although field conditions vary from one location to the next and from time to time, this test allows for a standard means of comparison and a laboratory method of evaluating air cleaner life and efficiency.

**Table 1 — Particle Size Distribution by Weight %**

Fine test dust is used for testing primary dry air cleaners that are most often used in on-road and automotive applications, and coarse dust is used for multi-stage air cleaners that typically use inertial separators and operate in very dusty applications.

Particle Size Range (in microns)	Weight %*	
	Fine (on-road)	Coarse (off-road)
0 - 5 μ	39 %	12 %
5 - 10 μ	18 %	12 %
10 - 20 μ	16 %	14 %
20 - 40 μ	18 %	23 %
40 - 80 μ	9 %	30 %
80 - 200 μ	0%	9 %

\* Percentage of weight can vary by ±2-3 % in each particle range



**Table 2 — Common Contaminants and Micron Sizes**

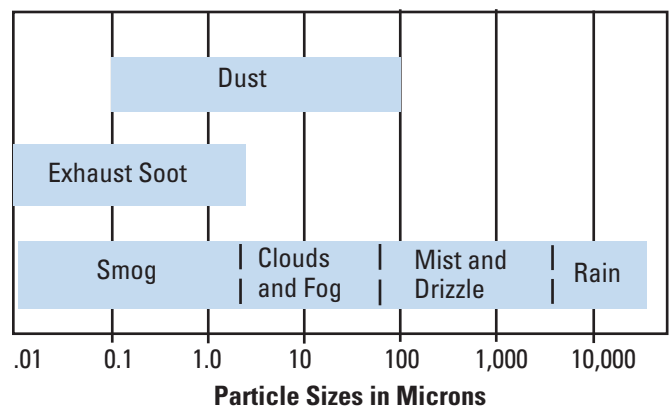

Reference: FMCTSB 04-03



## Filter Cleaning:

**Donaldson recommends servicing air filters by monitoring the airflow restriction levels in the intake system.**

**Some vehicle owners and maintenance supervisors, concerned with lowering their operating costs, will clean and reuse their heavy-duty air filters. Before you decide whether cleaning or washing of air filters is appropriate for your vehicle or fleet, please consider these factors:**

- Heavy-duty air filtration manufacturers do not recommend any type of cleaning process be used on their products. Donaldson, like other heavy duty air filter manufacturers, does not warrant the air filter once it has been cleaned.
- Filter dirt holding capacity is reduced 20 – 40% with each cleaning.
- Rather than cleaning or reusing filters, consider upgrading to an extended service filter (i.e., [Donaldson Blue®](#) air filters) and service the filter by restriction.
- There is a risk of dirt reaching the clean side of the filter while cleaning, plus possible filter damage from high pressure water or compressed air, making cleaning or washing a gamble. Be sure to add the potential cost or risk of filter damage to the cost of cleaning when determining the value of a filter cleaning process.
- Damaged filters should not be cleaned or reused. If a filter is damaged in service, investigate the source of damage and make corrections to avoid future damage.
- Reusing a cleaned heavy-duty filter increases the likelihood of improper air cleaner servicing because of the shortened service life. Each time the air intake system is serviced, it is exposed to the chance of contamination.
- Never attempt to clean a safety filter. Replace it after three primary filter change outs.



Reference: FMC Technical Service Bulletin 89-4R2.

## What is the Purpose of a Safety Filter?

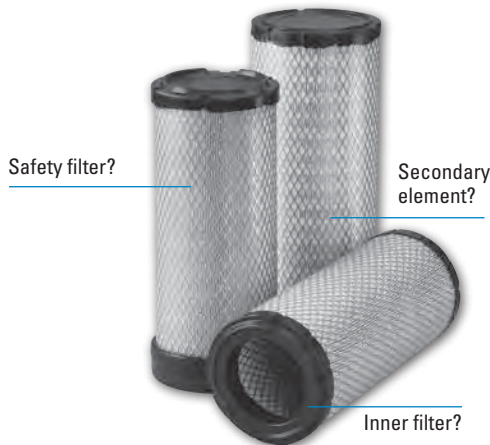

Safety filter . . . Secondary element . . . Inner filter . . .  
Spare filter? These filters go by many names . . .

At Donaldson we prefer to call it a “safety” filter. A safety filter backs up the primary (main) filter and protects the engine while the primary filter is out of the housing during servicing. The engine should never be run with only a safety filter in place.

The safety is NOT a spare filter! Its purpose is to protect the engine if something goes wrong with the primary (main) filter. Until then, it quietly does its job.

Compared to a primary filter, the safety filter is more open for lower restriction and is less efficient. A safety filter does not increase the overall operating efficiency of an air cleaner.

A safety filter is there to protect the engine against hidden damage to a primary filter — damage from cleaning, mis-installation, a “will-fit” that doesn’t quite fit, or the installation of the wrong size filter. A safety filter is never to be used as a “spare” filter.



## Switching from a Scheduled Maintenance Air Filter to an Extended Service Filter?

Interested in switching your scheduled maintenance air filter to Donaldson Blue® extended service air filter?

- Use only Donaldson Blue® Air Filters
- Maintain accurate records of current competitive cellulose media change intervals
- Keep accurate track of miles driven with Donaldson Blue® air filters and maintenance records
- Provide filter for inspection
- Rely on your filter service indicator to tell you when to change out your primary filter.
- Standard Donaldson warranty terms and conditions apply

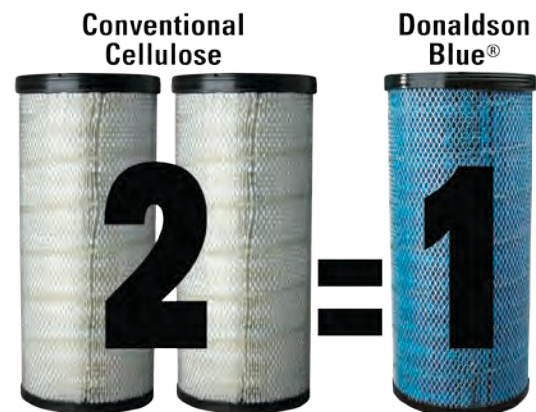

## Installation Guidelines for STB Strata System

### Positioning the Strata™ Pre-Cleaner

- It is usually best to have the pre-cleaner positioned above the hood of the vehicle so that cleaner air (above the dust cloud) can be drawn into the unit.
- The pre-cleaner section should be below the exhaust stack. Be careful NOT to mount the Strata™ pre-cleaning section in such a way that it draws in exhaust gases from the exhaust stack.

If the pre-cleaner cannot be positioned according to the above guidelines, consider adding an extension to put the intake point at a higher level.

- The extension should be added above the Strata tube section, below the inlet hood.
- Do NOT mount the Strata pre-cleaner on top of the extension as its weight would make the arrangement top heavy and unstable.

### Scavenge Hose

The scavenge line between the air cleaner and the exhaust ejector should be kept as short and as straight as possible. The ideal scavenge hose length for a Strata system is under five feet and should never be longer than 10 feet.

Minimize bends and be sure that the hose is supported properly. (Unsupported lengths of hose should not exceed five feet.) Bend radii of the hose should not be less than 15 inches. Minimize the number of 90° bends — preferably two or fewer.

Donaldson recommends three-ply silicone hose for the scavenge line. All Donaldson hose is supplied in 3-foot lengths (do not use flexible metal nor rigid tubing).

STB Model	Scavenge Outlet OD	Hose Part No	Hose ID
B160071	2.0"	P171381	2.0"

### Connecting Scavenge Hose to Pre-cleaner

A check valve is built into the Strata Pre-cleaner. Connect the scavenge hose directly to the outlet tube with a clamp. A Donaldson lined hose clamp is recommended (see Intake Accessories section).

### Connecting Hose to Ejector

When connecting the scavenge hose to the exhaust ejector, leave 2" (52 mm) between the end of the hose and the body of the ejector.

### Exhaust Ejectors

See the accessories section for details on our exhaust ejector product offering.

Do not add or create any additional back pressure downstream (e.g., at the exhaust outlet) of the Strata pre-cleaner. Doing so may cause exhaust back flow to the pre-cleaner.

Examples of what NOT to do: mount a spark arrestor on top of the ejector, or operate with a stuck or frozen rain cap on the exhaust ejector.

## How the Strata™ System Works

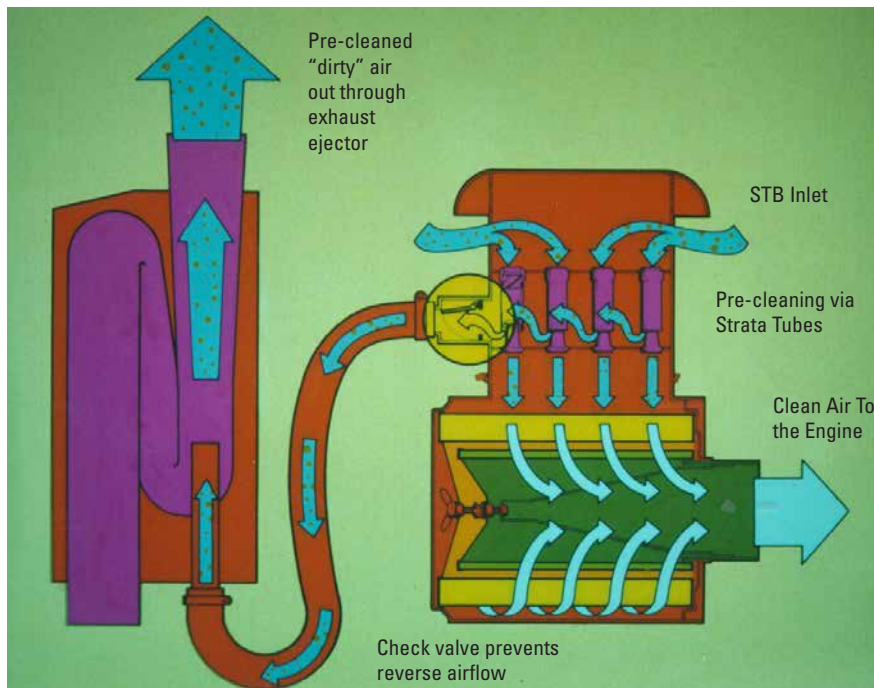

Note: Scavenge Hose, Exhaust Ejectors, Clamps Sold Separately

AIR FILTRATION TECHNICAL REFERENCE

### Q: Why am I experiencing short air filter life?

A: The amount of dirt an air filter can hold before servicing depends on many variables. The environment must be considered (severe dust, soot, and moisture) as it is crucial to know how much contaminant reaches the filter. This depends on the severity of the environment and whether the air cleaner is a one- or two-stage design. Another factor is the size of the air cleaner and filter relative to the airflow requirement. How long a filter lasts is largely a function of the Original Equipment Manufacturer's intake design.  
*Reference FMC TSB 89-3R3 and 06-2 for further details.*

### Q: What is the micron rating of my air filter?

A: Typically, air cleaners and air filters are not assigned a "micron rating." Micron rating is a term used in liquid filtration. Air filters are evaluated for efficiency using an industry-wide standard ISO 5011. Efficiency is the percentage of contaminant that a filter removes from the intake air relative to its capacity.  
*Reference FMC TSB 04-3 for further details.*

### Q: What do inches or millimeters of H<sub>2</sub>O have to do with an air cleaner?

A: In an intake filtration system the resistance to airflow is called restriction. Restriction is typically measured in units called inches or millimeters of H<sub>2</sub>O vacuum, and is defined as the difference in static pressure between the atmosphere and the outlet side of the system being measured. The higher the restriction the harder an engine has to work to obtain clean air for combustion. Engine manufacturers specify a restriction level at which the air filter should be serviced.  
*Reference FMC TSB 89-3R3 for further details.*

### Q: Why do some air filters require U.L. approval?

A: Some engine air filters utilize flame retardant filter media to meet UL safety requirements. The U.L. rating covers fire safety and backfire resistance aspects of industrial trucks with internal-combustion engines, such as tractors, platform-lift trucks, fork-lift trucks, and other specialized vehicles for industrial use. These requirements do not cover other possible safety aspects of such equipment. Additional information can be found in UL 558 specification.

### Q: Can you judge air filter service life by visual inspection?

A: Visual inspection is not a recommended method for determining an air filter's service condition. Measuring intake system restriction is the most reliable determination of filter life. Service by restriction allows the filter to remain in service until the maximum allowable restriction limit for the application is reached. Various restriction indicating devices are available for this purpose.  
*Reference FMC TSB 89-3R3 for further details.*

### Q: Can I replace my axial seal filter with the new RadialSeal™ design?

A: Axial seal and RadialSeal air filters are designed to seal differently. "Radial" sealing design filters cannot be fitted into a housing design for axial sealing replacement filters without the use of a conversion kit.

*Reference FMC TSB 97-3R2 for further details.*

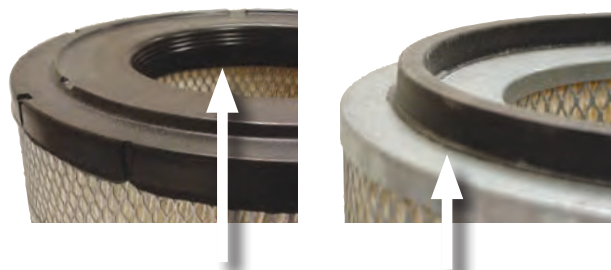

**RadialSeal™ Technology**  
 RadialSeal filters slip easily on and off the outlet tube during installation and service. This design eliminated the separate gaskets used with metal endcap filters.

**Axial Seal**  
 Axial seal style filter has a metal endcap with an attached gasket. This design requires housing cover pressure on a gasket to create the critical seal.

### Q: Can heavy duty air filters be cleaned or reused?

A: Most heavy duty air filter manufacturers do not recommend any type of cleaning process to be used on their products. Furthermore, they do not warrant their product once it has been cleaned.

Donaldson does not recommend cleaning filters. Cleaning a filter in any way, will void the filter warranty.  
*Reference FMC TSB 89-4R2 for further details.*



### Q: Will more frequent servicing of my air cleaner extend my engines life?

A: Just the opposite, over-servicing will cause increased service cost, time and material and dust contamination of the engine due to:

1. Filter damage, due to excessive handling,
2. Improper installation of filter,
3. Increased initial inefficiencies.

Reference FMCTSB 89-3R3 for further details.

### Q: What is a scavenged intake system?

A: Some intake system pre-cleaners are inertial separating devices that require a scavenge flow of air to function properly. The scavenge flow is required to expel the inertially separated dust particles from the pre-cleaner assembly. Scavenge flow is typically provided by a vacuum from an exhaust ejector that may be designed in as a function of the exhaust system muffler or as an add-on exhaust ejector stack.

Scavenged systems are typically specified on severe-duty applications to increase airflow and extend primary filter life.

### Q: What's the best type of pre-cleaner for a given application?

A: Intake system pre-cleaners are typically inertial separating devices intended to work in conjunction with the air cleaner to clean intake air prior to the final filtration stage provided by the filter. Separating some of the contamination from the intake air prior to reaching the filter provides an increase in filter service life. The type of pre-cleaner recommended for an application typically will depend on the severity of the environment. To maximize filter service life, choose the pre-cleaner design that provides the best efficiency within space and weight limits of the application.

### Q: When should I service an air filter?

A: The filter in any air cleaner should be serviced when the maximum allowable restriction, established by the engine manufacturer, has been reached. The filter should not be serviced on the basis of visual observation because this will generally lead to over-servicing.

Over-servicing will cause increased service cost, both time and material, and may cause dust contamination of the engine due to:

1. Filter damage from excessive handling,
2. Increased chance of improper installation of filter,
3. Increased initial inefficiencies.

### Achieving Maximum Air Filter Efficiency

The efficiency of an air filter increases as it is used. As soon as the air filter is put into operation, it begins to remove harmful dust particles. As these particles accumulate throughout the filter media, the microscopic openings in the media become obstructed. This on-going reduction in the size of the openings helps the filter stop increasingly finer dust particles, thus resulting in a more efficient filter. As the filter continues to plug with contamination, the restriction to air flow will increase. Most engine manufacturers establish a maximum degree of vacuum in the air induction system that the engine can tolerate and still operate efficiently.

### Measuring Restriction in Air Cleaners

As a dry air cleaner filter becomes loaded with dust, the vacuum on the "engine side" of the air cleaner (at the air cleaner outlet) increases. This vacuum is generally measured as restriction in "H<sub>2</sub>O or Kpa.

The engine manufacturer often places a maximum allowable limit on the amount of restriction the engine can withstand without loss of performance before the filter must be serviced.

Mechanical gauges, warning devices, indicators, and water manometers are available to inform the operator when the air cleaner restriction reaches this recommendation limit. These gauges and devices are generally reliable, but the water manometer is the most accurate and dependable.

To use the manometer, hold vertically and fill both legs approximately half full with water. One of the upper ends is connected to the restriction tap on the outlet side of the air cleaner by means of a flexible hose. The other end is left open to atmosphere. With the manometer held vertically and the engine drawing maximum air, the difference in the height of the water columns in the two legs — measured in inches — is the air cleaner restriction.



A restriction indicator's "lock-up" restriction level is generally marked on the indicator itself. A quick method to check a visual indicator is to remove it, wipe the base clean, then suck on the indicator with your mouth. If the indicator locks up, it is operational, if not, replace indicator. A more accurate method is to check the calibration against a water manometer.

### Q: Why Service?

A: Proper air cleaner servicing will result in maximum engine protection against the ravages of dust. Proper servicing can also save you time and money by increasing filter life and efficiency.

Two of the most common servicing problems are:

- 1) Over-servicing — new filters increase in efficiency as dust builds up on the media. DON'T BE FOOLED by filter appearance, it should look dirty. By using proper filter restriction measurement tools you will use the full life of the filter at maximum efficiency.
- 2) Improper servicing — your engine is highly vulnerable to abrasive dust contaminants during the servicing process. The most common cause of engine damage is due to careless servicing procedures. By following the steps shown in this catalog, you can avoid unnecessary dust contamination to the engine.

### Q: Why Would a Heavy-Duty Diesel Engine Air Filter Collapse

A: Most reputable filter manufacturers design their air filters to operate well beyond the recommended engine intake restriction service points. In fact, there is usually a safety factor of at least 2 – 3 times over the stated service point. However, there are circumstances when filter collapse can take place. When an engine is operating with a collapsed filter, there is a good chance that unfiltered air is getting to it, which could result in costly repairs. Most of the time poor maintenance is the cause, but there are some operating conditions to consider as well.

Collapse of a heavy-duty air filter is defined as a permanent deformation of the unit after airflow is removed. This occurs when the pressure drop across the filter exceeds the design limit of the device. Because of the safety factors built-in when the filter is engineered, this is an unusual event and is normally preventable.

A common cause of filter collapse is not paying attention to the service point recommended by the engine manufacturer. Diesel engines typically have an intake filter service point of 20-30" H<sub>2</sub>O (5-7.5 kPa), depending on the manufacturer. As stated above, exceeding this by an incremental amount won't cause the filter to collapse, as they are designed to withstand

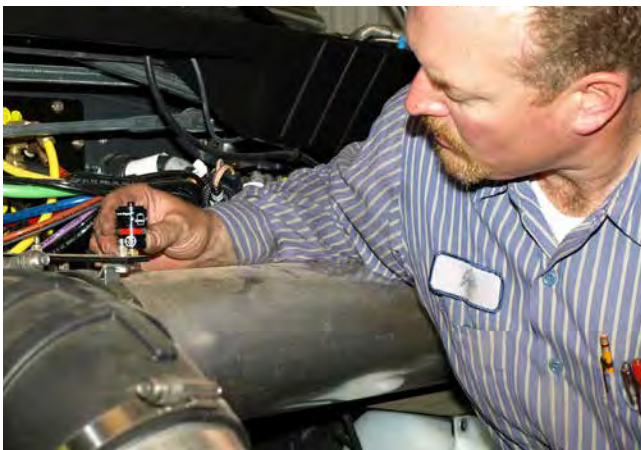

a much higher level of restriction. However, because filters tend to load very quickly after a certain point, not servicing them soon after the maximum allowable restriction is reached (as recommended by the engine manufacturer) can end up causing a very high level of pressure drop across the filter, and may result in a collapse condition. The best way to avoid this is to install and monitor a restriction measuring device (gauge, pop-up indicator or dash light), and replace the filter when it indicates the service point has been reached.

Another possibility of filter collapse is sub-standard filter construction or remanufacture. Generally, obtaining air filters from a reputable manufacturer will avoid this issue. Quality heavy-duty air filters are made with materials that can withstand high levels of pressure drop and resist collapse, while sub-standard filters may not. It is also important to inspect all filters before installation. Dented liners or end caps may result in a loss of structural integrity and filter collapse.

Damage may be present but not very visible. If the filter shows any sign of damage, don't use it. This is especially critical when using cleaned filters. Couple the possibility of damaged filters with weakened media (if it were washed or cleaned with too high of a pressure) and the filter may have a much lower resistance to collapse. Operating conditions should be considered as well. For example, high levels of soot (generally from diesel engine exhaust) can plug an air filter rapidly, which may shorten the life of a filter dramatically. If a restriction indicating device isn't monitored closely, an extremely high pressure drop across the filter could occur, which could cause it to collapse. If high levels of soot are experienced, the cause of the ingestion should be investigated and, if possible, corrected. These include (but are not limited to) proximity of the intake to the exhaust; exhaust leaks near the air intake; vehicles operating or idling in close quarters; and operating in certain areas where exhaust concentrations are high.

Extremely high levels of water ingestion can be a concern, too. Although most filters can take a certain amount of moisture with no problems, large amounts of water can weaken and plug the filter media long enough to cause collapse. However, this is an unusual situation because most vehicles that are likely to be used in these types of conditions have a water separation device installed. One possible cause of excessive water ingestion not often accounted for is the introduction of high levels of moisture during the washing of the vehicle. The best practice is to ensure the engine is not operating during washing and water is not sprayed directly into the engine air intake.

In summary, following the engine manufacturer's service recommendations, using quality undamaged products and using a restriction indicating device are the best practices to prevent air filter collapse. If a filter collapse occurs, it is important to ascertain whether lack of maintenance caused the problem or if the vehicle is used in conditions that dramatically shorten filter life, and then take corrective action to keep it from happening again.





Off-Road Case Study  
**PowerCore® Air Cleaner**

Despite heavy concentrations of dust and soot, the Donaldson PowerCore® Air Cleaner helped keep a dozer in the field when it was most needed.



Frank Keath (right) with son Colin stand with the Fiat FD14E Dozer.

As respected members of the Country Fire Association (CFA) Frank Keath of Keaths Excavations along with sons Colin, Andrew and Graham and the company's service mechanic Andrew, were at the forefront of beating back bush fires that recently threatened properties around Eildon and neighbouring Marysville. At the height of the bushfires, Keaths Excavations deployed each of their units including three Hitachi Excavators, two Fiat Dozers, a Caterpillar Grader, a Cat Excavator and two smaller Backhoes to help build firebreaks and retainers.

Frank recalls that the conditions at the height of the fires in the Marysville area were "the most extreme conditions I have ever faced" with the air full of engine-arresting dust and soot.

"The soot was like thick layers of Talcum powder," he says.

Despite these conditions, Frank praises the recently fitted Donaldson D100031 PowerCore® Air Cleaner as helping keep his equipment in the field when it was needed the most.

Given that it can take less than half a cup of dust to destroy an engine, having an efficient air filtration system is a necessity in hot and dusty conditions. In such conditions, the engine's ability to breathe and provide optimal performance can be compromised.

In Frank's experience with the PowerCore unit, he found that the PowerCore filter lasted substantially longer than other units with which he has had experience.

"The PowerCore achieved 150 hours in the field. That may seem quite small but due to the extreme nature of the conditions and the sheer amount of smoke, dust and soot in the air, the PowerCore unit far outlasted traditional filters which struggled to provide 50 hours worth of life," says Frank.



The D100031 PowerCore air cleaner.





The Dozer at work (above and below) during the clean up of the Marysville area. The dirt and soot left in the aftermath can badly affect engine performance.

The PowerCore unit was fitted to a Fiat FD14E Dozer after consultation with Hitachi Aftermarket Parts Specialist George Calyk and Donaldson Australian Territory Manager, Tony Cooper.

Keaths Excavations fitted the unit themselves at their newly opened service workshop at Yarck. The unit was mounted vertically in the Dozer's engine housing. The Keaths Excavations team chose to install an aluminum reflector plate between the engine and the PowerCore unit to protect the unit from any radiant heat from the engine. Servicing the PowerCore unit is straightforward as the four retaining clips on top of the unit remain accessible and away from heat allowing for easy removal of the PowerCore filter.



PowerCore filters feature a patented technology that provides maximum filter efficiency with contaminant holding capacity greater than that of traditional cellulose filters. PowerCore filters are also available with Donaldson's patented nanofiber Ultra-Web® technology which provides even greater performance and protection. The performance abilities of the filter media are augmented by the design of the PowerCore unit itself which features a unique, built-in, pre-cleaning section that removes up to 98.9% of heavy contaminant before it hits the filter. This makes the PowerCore unit the perfect solution for high dust environments or environments where fine contaminant can pose a risk to engine performance.

equipment that needs to be in peak performance over extended periods.

In Frank Keath's opinion, the PowerCore unit more than did its job and he remains impressed with the performance of the unit as the clean up in the Marysville area continues. When not fighting fires, you'll find Frank, Colin, Graham, and the two Andrews of Keaths Excavations, a Hitachi Dealership, at their service centre on the Maroondah Highway, Yarck, Victoria. Keaths Excavations specialize in providing earthmoving, landscaping, construction and excavation equipment and associated services including off road vehicle maintenance for a wide range of heavy-duty equipment. The team can be contacted on (03) 5773 4242.



10" PowerCore units are available

PSD PowerCore air cleaner line was designed with the idea that most newer machinery has less available space under the engine cowling or hood than older equipment. By combining compact sizing with multiple options for mounting the unit horizontally or vertically, the PSD product offering becomes a perfect retrofit solution for

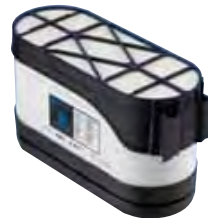

PowerCore aftermarket filters are quick to replace making service a breeze.



Donaldson Company, Inc.  
PO Box 1299  
Minneapolis, MN  
55440-1299

[www.donaldsonfilters.com](http://www.donaldsonfilters.com)  
[www.donaldson.com](http://www.donaldson.com)

United States  
Canada  
Mexico  
Latin America

Caribbean  
Brazil  
Europe  
South Africa

South East Asia  
Greater China  
Japan  
Australia  
India

Brochure No. F113027 (02/10)  
© 2010 Donaldson Company, Inc. All rights reserved. Printed in the U.S.A. Donaldson Company, Inc. reserves the right to change or discontinue any model or specification at any time and without notice.





## Methods for Diesel Engine Air Intake and Filtration System Size Reductions

Dan Adamek, Director-Engine Air Filtration Development

September, 2008

### TECHNICAL BULLETIN

#### Current Situation

Innovative vehicle designs and increased environmental awareness call for new engineering solutions for on-road and off-road vehicle components. Diesel engine air intake suppliers are facing increasing challenges as vehicle manufacturers demand higher performance in a smaller volume while minimizing life-cycle costs. This paper will discuss the market drivers behind these changes, air filtration solutions that have worked in the past, and a new filter technology that promises to better meet these increasing challenges.

Many factors are affecting the changing demands on diesel engine air intake systems. One of the most prominent changes in the market is the various emissions standards being adopted around the world (Fig. 1).

These new requirements not only increase the space consumed by advanced emission components, but also impact other vehicle parameters. For example, current and future diesel engine designs are placing more emphasis on lower restrictions in the air intake system, as higher restrictions can increase the emission levels being measured in the engine exhaust.<sup>1</sup>

These air intake system pressure losses have long been considered during vehicle and component design to minimize the performance and fuel efficiency penalty that these restrictions incur. Although fuel efficiency changes due to diesel engine intake restriction changes appear small on a percentage basis (<1%<sup>11</sup>), the annual additional fuel usage with a sub-optimal air filter can easily exceed the original purchase price of the filter. With continued increases in fuel costs, efforts to squeeze additional fuel economy out of vehicles have resulted in additional time and expenses being allotted to lowering these intake losses. These fuel savings also translate into reduced CO<sub>2</sub> emissions. In addition to benefiting our environment, CO<sub>2</sub> reductions will result in additional financial benefits in regions where taxation is based on vehicles emissions.

Many manufacturers are placing more emphasis on safety, and improved visibility for the vehicle operator is one part of those efforts. This has resulted, in some cases, in the lowering of engine compartment hoods in order to improve the operators' sightlines. The effect of lowering the vehicles' engine compartment hoods has been an additional reduction in space for components such as the air intake systems.

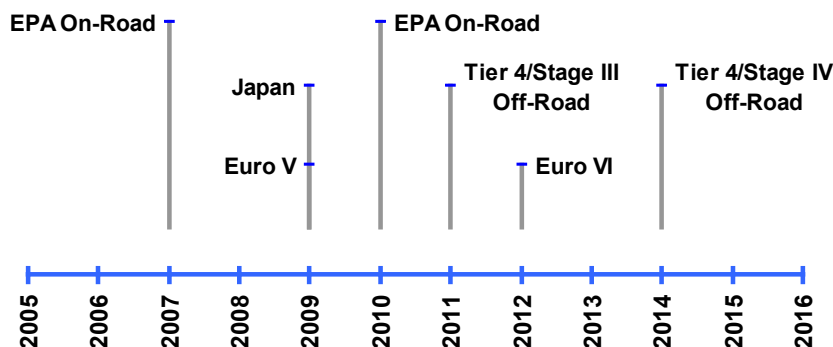

Figure 1. Diesel Engine Emission Regulation Target Dates

In the search to improve the value provided by vehicle components, air intake system life cycle costs continue to be examined. This can often take the form of either increasing the air filter's life at equal cost, or reducing the air filter cost at equivalent life. In some cases, customers are looking for ways to reconfigure the air intake system layout to reduce cost. In on-highway trucks for example, behind the cab air intake systems have been typical for some regions because of the under hood space constraints. Size reductions in the system can allow for alternate configuration such as a frontal intake system. This can shorten the ductwork thereby reducing costs and also utilize the engine compartment to mitigate noise transmission through the inlet.

These market drivers are challenging air intake system providers to deliver products that simultaneously improve multiple system properties that have historically been engineering trade-offs.

### Engineering Approach

Design of diesel engine air intake systems requires the integration of many technologies and the balancing of many factors. Figure 2 is a simple graphic illustrating how the primary value measurements of a system can be affected by design changes in other system properties.

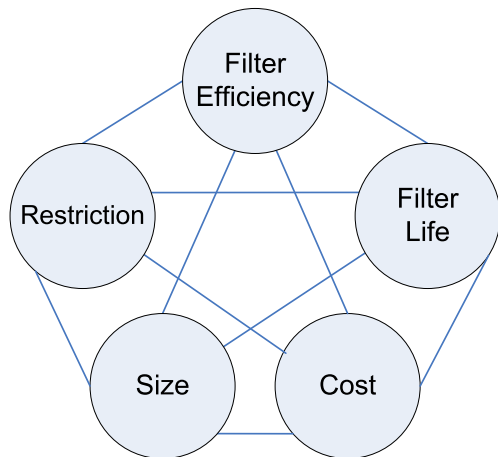

Figure 2. Air Filter Primary Design Tradeoff Relationships

At a given technology level, each property can be improved through compromises in another property. For example, size can be reduced by reducing filter efficiency, reducing filter life, or increasing filter pressure loss. Advancements in technology are required

to achieve simultaneous improvement in multiple parameters. These technology advancements can take several forms, from simply improving via design and materials expertise, to the utilization of advanced tools such as computation fluid dynamics (CFD), to the development of breakthrough configurations (Fig. 3).

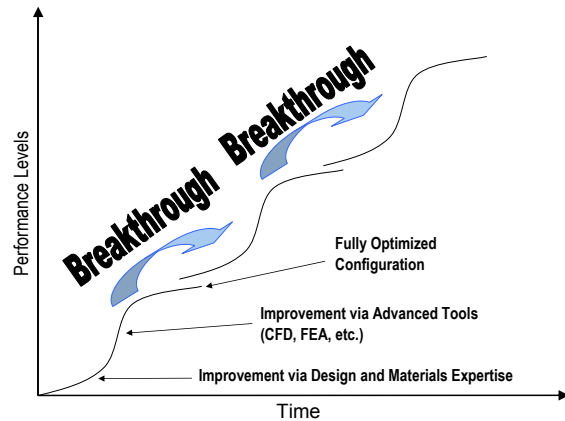

Figure 3. Typical performance advancement means and rates

Other system requirements need to be addressed during the design process as well, and can include items such as noise attenuation, elevated temperature operation, chemical resistance, durability under vibration and shock, and many others.

The ability of a supplier to satisfy these diverse air intake system requirements is perhaps most determined by the design and performance of the air filter. The air filter removes contaminant from the air in order to protect the engine from damaging wear. Engine wear rates have been calculated to decrease by a factor of 10 when high efficiency air filters are used in place of standard efficiency filters.<sup>iii</sup>

High efficiency levels have been achieved through the optimization of the fibrous structure of the filter media. The use of nanofibers on the media surface (Fig. 4) has allowed the thickness and density of the media to be reduced thereby decreasing the pressure losses through the media and the amount of material used. These nanofibers also show very high initial efficiency compared to standard cellulose media which only achieves its targeted efficiency level after it has built up a sufficient dust cake on its surface.

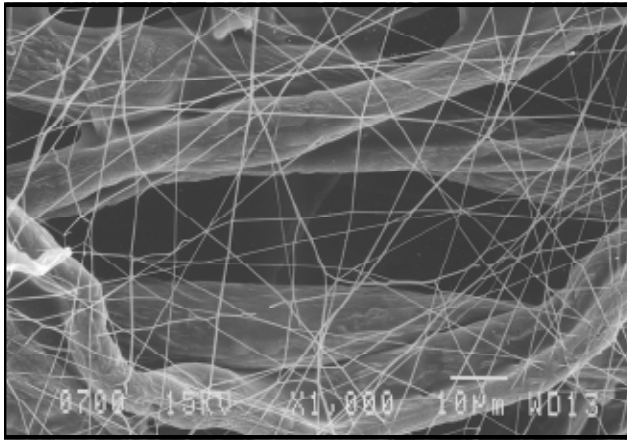

Figure 4. Scanning Electron Microscope photograph of Donaldson's Ultra-Web® nanofiber filter technology

The build-up of contaminant on the filter media causes pressure losses to increase over time, until it reaches a magnitude which is determined to be the maximum allowable by the engine. This filter life is desired to be as long as possible to minimize the cost of filter replacement. The ability of an air filter to load slowly, that is have low pressure loss for an extended period of time, is also important because the longer an engine operates at low restriction, the lower the average fuel consumption that can be achieved.

## Product Solutions

Cylindrical filters have been the technology of choice in the past. The radial seal version of this type of filter was an advancement that occurred in the 1980's that enabled the transition from metal air cleaner housings to polymeric housings, thereby greatly reducing product costs and improving product quality.



Figure 5. Conventional filters (axial and radial seal).

A breakthrough alternative to cylindrical filters for diesel engine air intake systems was introduced in the 1990's. Donaldson's PowerCore filter demonstrates an axial flow arrangement that allows the airflow to pass straight through the filter without the 90° change in direction that is required for cylindrical filter configurations. This simplified airflow path decreases the potential pressure losses within the air intake system.

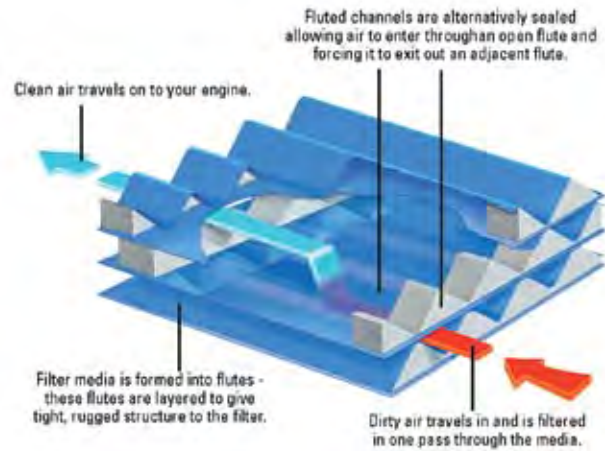

Figure 6. Schematic representation of airflow through axial flow PowerCore air filter



Figure 7. Example of an axial flow PowerCore intake system.

While axial flow style air filters have proven their value to vehicle manufactures, very recent advances in this style of filter have achieved even higher levels of performance. PowerCore G2 is an advanced, next generation axial flow filter that has optimized the internal configuration of the filter such that every geometric feature within the filter has been reconfigured to reduce pressure losses and increase filter life (Fig. 8).

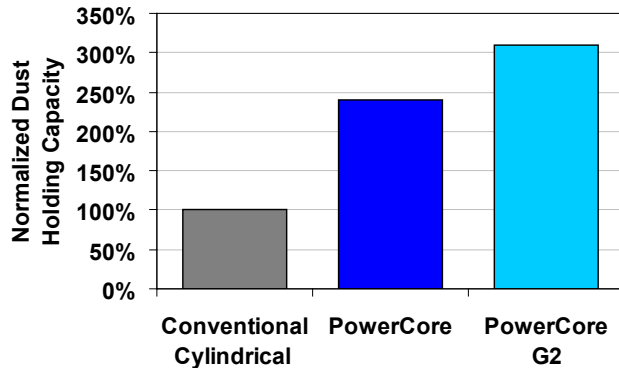

Figure 8. Normalized ISO fine dust capacity for equal sized air filters. Performance may vary with geometry and operating conditions.

One challenge in air filter design and particularly in axial style filters is the effort to minimize the media area that is unutilized or underutilized due to masking. PowerCore G2 reduces media masking when compared to previous axial flow air filters. Because increases in effective media area decrease the velocity through media, it has the dual effect of decreasing the pressure loss across the media and reducing the loading per unit area. Therefore, the increase in life is higher (Fig. 9) than the increase in effective media area.

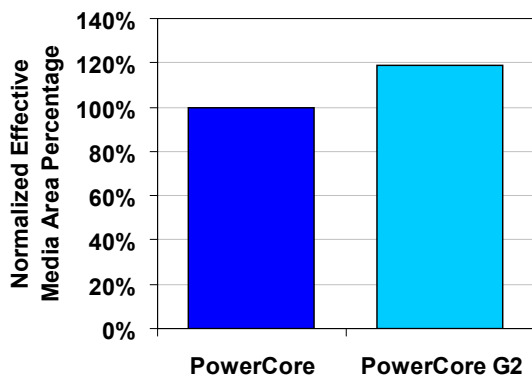

Figure 9. Normalized effective media area as a percentage of total air filter media area. Performance may vary with geometry and operating conditions.

Additionally, PowerCore G2 has been designed to allow for increased total media area to be packaged into a filter through a unique media forming process. This can lead to increased filter life when combined with the correct filter channel configurations. (Fig. 10)

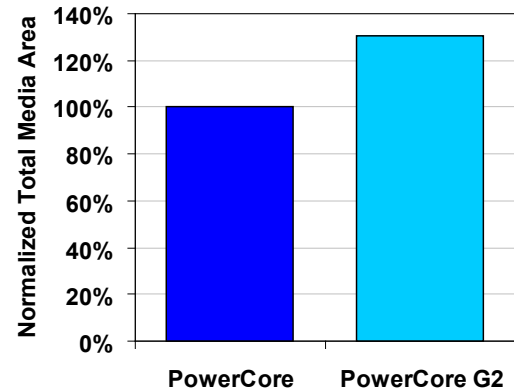

Figure 10. Normalized total media area for equal size air filters. Performance may vary with geometry and operating conditions.

Channel pressure losses can be lowered through increasing the air filter's channel size. This also decreases the amount of media, however, so the application requirements need to be factored into the choice of channel size.

Increases in channel space can also be obtained by utilizing thin filter media. Nanofiber laminates allow for thinner media because particulate efficiency increases as media fiber size decreases.

The effect of these changes and others on filtration performance has been theoretically modeled using fluid mechanics and advanced filtration theory. The use of advanced modeling tools has allowed optimal configurations to be determined by comparison of the performance of millions of unique axial flow filter configurations. Prototypes of these selected configurations have been tested and validated against the theoretical model. Figure 11 shows an example of the restriction increase versus dust loading of an advanced axial flow filter and a previously available axial flow filter.



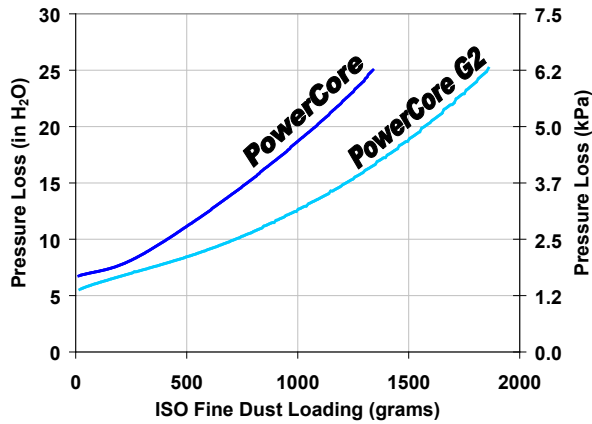

Figure 11. Example ISO Fine Dust Loading for Equal Size Element at Constant Flow rate. Performance may vary with geometry and operating conditions.

While this example illustrates achieving improved life for a constant volume, it would be a straightforward matter to provide an air filter with equal life, but smaller volume utilizing these technology advancements. Another benefit that can be seen in Figure 11 is that PowerCore G2 can provide a lower pressure loss throughout the loading period. This lower weighted average pressure loss translates into potential increased fuel efficiency and a more desirable condition for emission performance. However, in applications where initial pressure loss is less of a concern, even greater air filter life than shown in Figure 11 may be obtained with PowerCore G2.

PowerCore G2 has been developed as a family of air filtration solutions. By varying the parameters described above, greater performance can be achieved and therefore greater value can be provided to diesel engine and vehicle manufacturers. This technology breakthrough has allowed for simultaneous improvement in multiple system properties such as restriction, size, and life, and provides a variety of configuration choices in order to best match performance to customer needs.

### Conclusion

Continued demand for further reductions in air intake system size and restriction has resulted in innovative solutions such as PowerCore G2. For given filter life and efficiency targets, the PowerCore G2 configurations can result in a 30% reduction in size from previous axial flow filters and a 60% reduction in size from cylindrical filters (Figures 12 and 13). Additionally, improvements in restriction and air filter life are now possible with PowerCore G2.

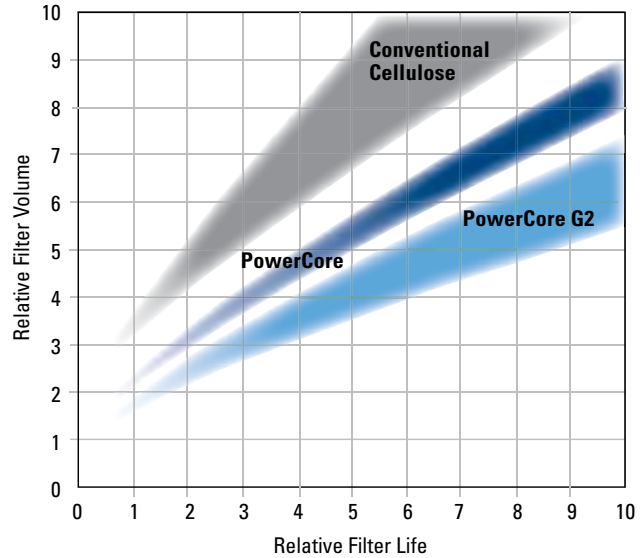

Figure 12. Relative air filter volume versus life. Performance may vary with geometry and operating conditions.



Figure 13. Photographic comparison of equivalent performance air filters of varying technology level.

### REFERENCES

- i Jaaskelainen, Hannu, "Emission Effect of Engine Faults and Service", [www.dieselnet.com/tech/emi\\_fault.html](http://www.dieselnet.com/tech/emi_fault.html).
- ii Deierlein, Bob, "Managing Fuel Consumption", *Fleet Equipment*, Dec. 2001.
- iii Barris, Marty A., "Total Filtration™: The Influence of Filter Selection on Engine Wear, Emissions, and Performance", SAE 952557, SAE Fuels and Lubricants Meeting & Exposition, October 16-19, 1995.



Technical Article

# Spiracle™ Crankcase Filtration Technology

**Author:**

Veli Kalayci  
 Spiracle™ Systems Team Leader

For more than 30 years, a focus on environmental air improvement has led original equipment manufacturers (OEMs) to require their manufacturing business partners to design filtration systems that reduce the amount of crankcase blow-by aerosols vented into the atmosphere from diesel engines. This push to reduce diesel emissions and other particulate matter (PM) contaminants from the atmosphere began in the 1970s with the passing of the U.S. Environmental Protection Agency (EPA) Clean Air Act, which regulated on-road diesel emissions and was later amended, in 1990, to include regulations for off-road diesel vehicles. These standards set maximum allowable levels of emissions for new diesel engines and diesel fuel that have been incrementally reducing emissions levels since 1988.

With the significant technology advancements achieved in curbing the exhaust emissions from the engine tailpipe, the relative contribution of the emissions from the crankcase blow-by aerosols started to become an increasing contributor in total engine emissions. Figure 1 shows the increasing relative contribution of crankcase emissions for on-road engines through 2007.

**FIGURE 1**  
**EMISSIONS CONTRIBUTIONS**  
**TAILPIPE & CRANKCASE**

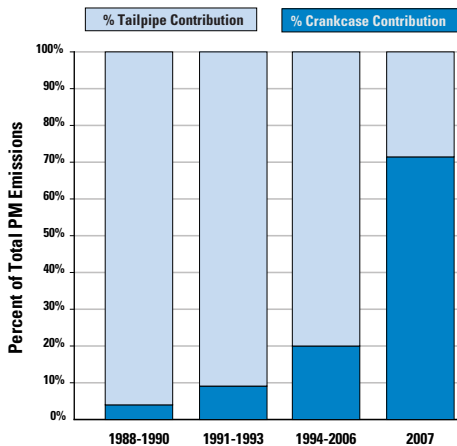

Crankcase emissions levels in diesel engines have remained relatively low compared to tailpipe emissions until 2006. On newer engines, as emissions from tailpipes reduce, crankcase emissions become a greater share of total allowable particulate matter (PM) emissions.

As these regulations evolved in the U.S. and around the world, Donaldson Company, a leading manufacturer of air and liquid filtration systems and replacement parts, led the industry in the development of crankcase filtration technologies with the Spiracle™ Crankcase Filtration Systems (CFS). The engineering advancements of Spiracle™ CFS have continually been used to help meet the EPA's stringent regulatory requirements by providing high efficiency filtration solutions to OEMs and fleet operators around the world.



Filtration Technology by Donaldson

### Crankcase Ventilation Filtration Systems

Crankcase ventilation filtration systems are designed to be either "open" or "closed" systems.

Open crankcase ventilation filtration systems (OCV) filter engine aerosols, including oil and soot, along with any bulk oil coming out of the valve cover or crankcase vent and discharges filtered air into the atmosphere.

In closed crankcase ventilation filtration systems (CCV), crankcase blow-by aerosols, including oil and soot, are filtered and the filtered crankcase flow is directed back to the intake manifold or to the turbo compressor. Using high efficiency closed crankcase filtration systems, the performance of intake filters, turbochargers, aftercoolers and exhaust system components can be maintained over extended engine usage.

### Crankcase Emissions from Diesel Engines and Emission Control

Crankcase emissions are created during the combustion process of reciprocating engines. The primary source of crankcase emissions are combustion gases and particulate matter (PM) that escape past the piston rings and enter the crankcase. Other sources of crankcase emissions include turbocharger shaft seal leaks, valve guides and general movement of parts. These "blow-by" gases must be vented through a tube into the atmosphere to avoid pressurizing and damaging components of the engine. After mixing with oil mists in the crankcase, the gases, PM, and oil aerosols either coalesce and drop out of the vent tube onto the ground, or enter into the atmosphere as pollutants.

Crankcase emissions vary greatly depending on a number of factors. Engine rating, displacement, engine operating conditions such as load, speed and the age of the engine all influence the blow-by volumetric flow rate, mass output rate and particle size

distribution. Just as important, the crankcase emissions can vary depending on the engine design especially the tolerances, materials, turbocharger, wear factors and operating conditions can impact the amount of blow-by escaping past the piston rings.

Donaldson has developed engine blow-by characterization methods and tools as part of its standard range of capabilities for crankcase filtration technology and product development. One such piece of equipment is a mobile blow-by characterization system that Donaldson uses to measure the blow-by output of diesel engines. The test bench can quantify the gravimetric and fractional content of the blow-by mass output, volumetric flow rate, pressure and temperature at different engine operating conditions.

**FIGURE 2**  
CRANKCASE BLOW-BY CHARACTERIZATION AT THREE ENGINE OPERATING MODES

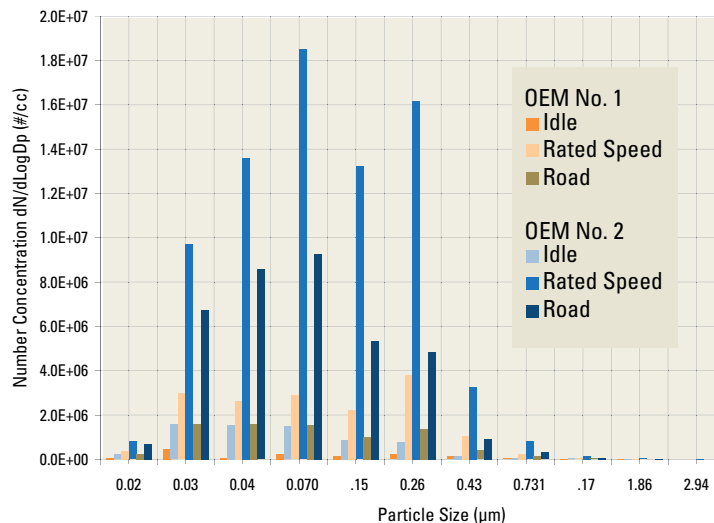

**FIGURE 3**  
PEAK ENGINE TORQUE COMPARISON WITH AND WITHOUT SPIRACLE™ FILTRATION SYSTEM

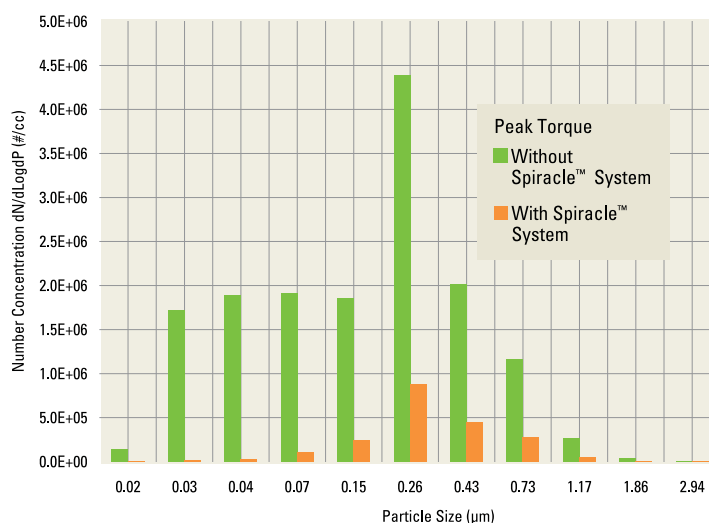

The mobile blow-by characterization system allows Donaldson to quantitatively assess their customers' crankcase emissions under dynamic conditions (Fig. 2 and Fig. 3) from their diesel engines and tailor filtration systems to address these needs. This cutting-edge technology allows Donaldson a unique capability in the industry and provides the benefit of custom designed products to fit customer needs.

It is imperative that crankcase filtration manufacturers develop products that can handle crankcase emissions that vary significantly over the operating range and life of the engine. In addition, these systems must be designed to operate in the extreme conditions for temperature, shock, and vibration – typical of medium- and heavy-duty applications.

### Spiracle™ Filtration Technology

Donaldson has a long track record of success with its Spiracle CFS technology. In an effort to meet EPA's continued mandates and realizing the health benefits to passengers<sup>(1)</sup>, school bus fleet owners have installed a Spiracle CFS combined with a second emissions reduction technology; i.e., Diesel Oxidation Catalysts (DOC), Diesel Particulate Filters (DPF) or a Diesel Multi-stage Filters (DMF). The combination creates a retrofit solution that delivers maximum emission reduction both inside and outside the bus.

Crankcase filtration manufacturers are challenged to tailor their products to meet a host of manufacturers' applications with differing size, efficiency, pressure loss, and life requirements while delivering high efficiency filtration and reliability.

With the introduction of Donaldson Synteq XP™, a revolutionary, patented filter media, Donaldson engineered the Spiracle CFS creating new open and closed crankcase filtration systems solutions.

**FIGURE 5**  
**PARTICLE SIZES AND FILTRATION PRINCIPALS**

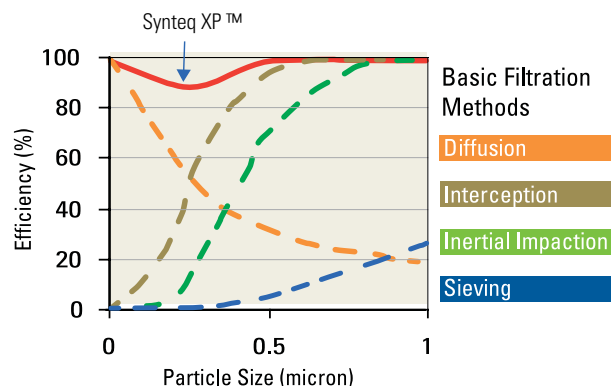

**FIGURE 4**  
**SPIRACLE SYSTEM ON A SCHOOL BUS**



As part of California ARB and US EPA emissions retrofit programs, over 16,000 units have been installed on school buses and trucks across the U.S.

The precise dimensions, shapes and innovative fiber bonding of the Synteq XP media provide the ideal solution for the challenge of balancing high efficiency and low pressure drop, and increased filter life.

Larger particles, typically from 1 to 10 microns are efficiently separated by interception and inertial impaction. Sub-micron particles, often the most harmful for compressor blades, are efficiently separated by diffusion. Donaldson's Synteq XP media is specifically designed to combine interception, inertial impaction and diffusion, thereby offering high efficiency for all particle sizes (see Fig. 5).

After the oil mist particles are captured, they are coalesced into larger droplets and drained from the media. The drainage within the media pack is also optimized. Pressure drop across the self-draining filter is kept low and stable over time, and no engine downtime is required to drain the oil out of the media pack.

The large pore size of Synteq XP media (Fig. 6) reduces the pressure drop across the filter. Multiple layers of the media allows custom design flexibility for a wide range of filtration efficiencies and field life depending on the needs and requirements of OEMs.

**FIGURE 6**  
**SCANNING ELECTRON MICROGRAPHS OF SYNTEQ XP™ MEDIA @ 200X**

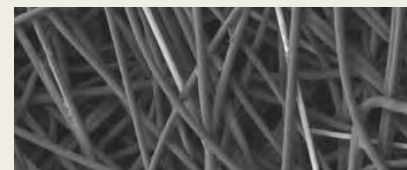

Close-up of Synteq XP media (clean)

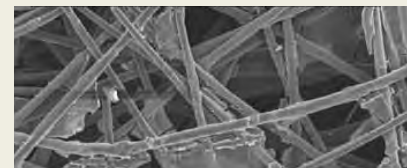

Close-up of Synteq XP media after 1200 hours of field use. The open areas that are free of contaminant offer additional filter service life.



One of the unique features of Synteq XP filtration technology is its exceptional ability to coalesce oil and then drain.

Oil that is held in the filter will increase pressure drop and reduce efficiency, resulting in shorter filter life. In Fig. 7, there is no wet line on the Spiracle filter shown on the right after 16 hours of operation. Better drainage means less pressure drop, better efficiency and improved life.

**FIGURE 7**  
**FILTER OIL LINE COMPARISON AFTER 16 HOURS**

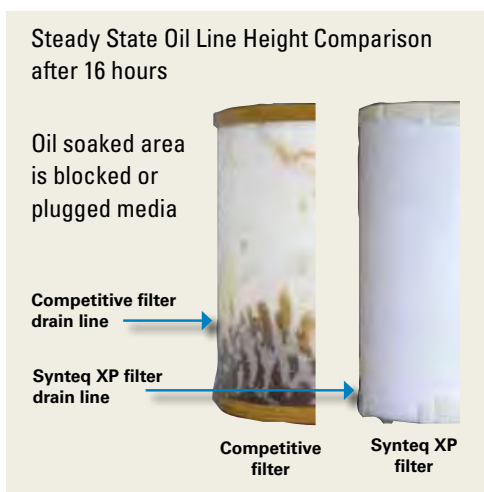

Better oil drainage means less pressure drop, improved efficiency and filter life.

Synteq XP media offers great flexibility to Donaldson engineers in customizing crankcase solutions. Spiracle CFS can be developed to any target gravimetric and fractional efficiency depending on the requirements of the customer and the diesel engine crankcase blow-by characteristics. This media technology offers the best combination of high efficiency with low pressure drop.

Synteq XP media in combination with a Spiracle housing for OCV or CCV applications allows increased engineering design flexibility (see Fig. 8) for custom fit solutions. This design flexibility translates into improved serviceability including mounting location and direction and aligning the filter service interval with other maintenance intervals to reduce downtime and maintenance costs.

**FIGURE 8**  
**CRANKCASE FILTRATION PERFORMANCE DESIGN FLEXIBILITY WITH SYNTEQ XP MEDIA**

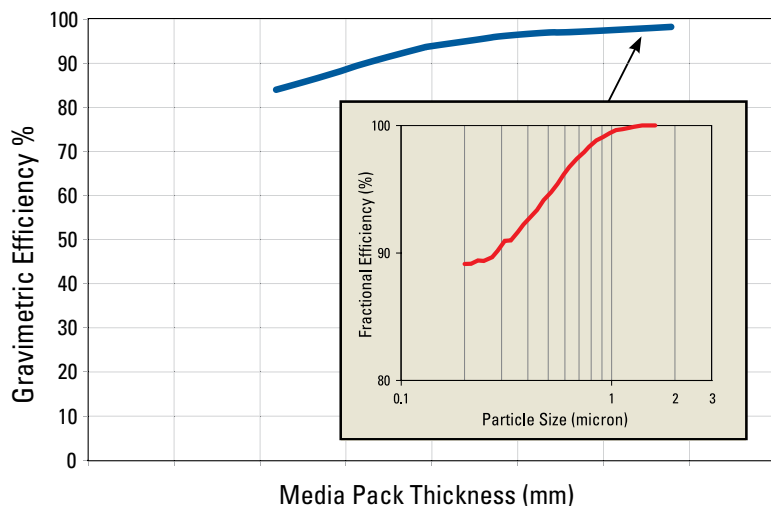

### A Better Product and Technology to Control Diesel Engine Crankcase Emissions

Donaldson Spiracle CFS is a serviceable unit. Its benefits include lower cost, higher efficiency, and reliability over a wide range of engine conditions and longer filter life creating less demand on the diesel engine.

#### Benefits of Spiracle CFS with Synteq XP Media include:

- ◆ Lower operating pressure drop
- ◆ Continuous oil drainage even at low pressure differentials
- ◆ Higher gravimetric and fractional efficiency including the sub-micron particle size range
- ◆ Longer filter life compared to traditional media

Donaldson Synteq XP media provides continuous drainage at low pressure differentials. Just as importantly, a Spiracle CFS provides high gravimetric efficiency at broad flow ranges in a dynamic engine operating environment where consistency is required no matter the duty cycle of the engine. The Spiracle CFS also provides high fractional efficiency on sub-micron particles. Sub-micron particles along with larger aerosol contaminants contribute to wear and damage to the air intake system components on diesel engines. Typical manifestation of such damage is wear on compressor blades and the housing of the turbocharger system, or a reduction in aftercooler efficiency which negatively impacts engine performance. This outstanding performance of the Spiracle filtration technology over any contaminant size range including sub-micron particles, clearly sets it apart from other



methods of filtering crankcase blow-by contaminants. The technology offers the added advantage of providing optimum filtration performance in low and high temperature extremes.

The Spiracle CFS does not have any moving parts and does not require any electric or hydraulic power to function; therefore, it does not require engine power to operate, which may otherwise cause parasitic losses and decrease fuel efficiency.

**FIGURE 9**  
**SPIRACLE SYSTEM SCHEMATIC**

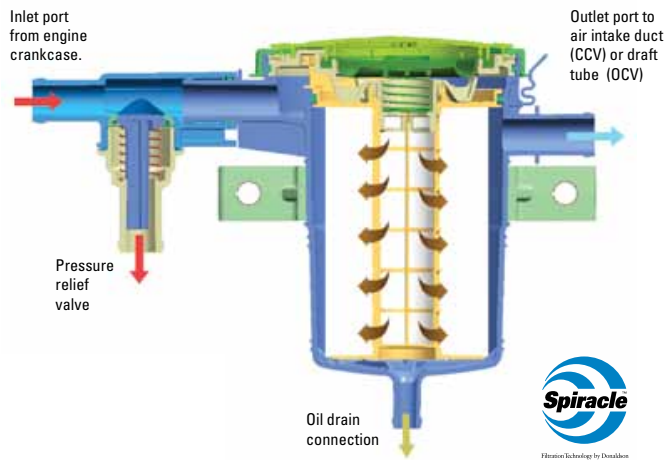

Due to its reliability over the life of the engine, Spiracle CFS is the ideal solution for controlling crankcase emissions whether in open or closed crankcase ventilation systems. As the soot and other contaminants build up on the Spiracle filters after extended engine use, typically over 1,500 hours, the end user simply replaces an

**SPIRACLE FILTRATION SYSTEMS ON ENGINES**

A - Outlet B - Inlet C - Oil Drain

**FIGURE 10**

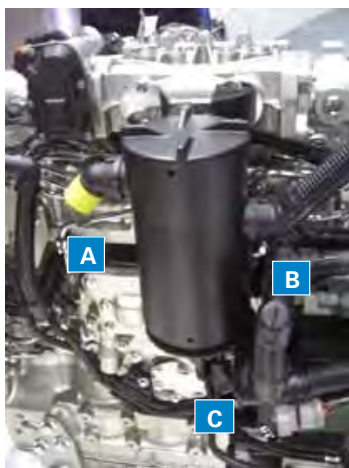

**FIGURE 11**

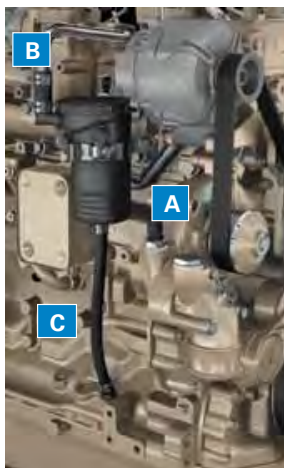

inexpensive, easily accessible filter. This can be accomplished quickly (typically under 1 minute), thus resulting in minimal downtime servicing the engine and more vehicle uptime. Periodic replacement of the filter returns the system to a known performance level each and every time.

Donaldson Spiracle Systems deliver high performance crankcase filtration over all engine operating conditions. Figure 10 and 11 show examples of Spiracle CFS on engines.

**"Green" Benefits**

At Donaldson, we protect our customers' engines by cleaning the air going into the engine, all the fluids around and throughout the engine, and the exhaust gases coming out of the engine. In turn, our filtration systems are improving the sustainability of the environments in which they are used.

Spiracle CFS offers the following green benefits:

- ◆ reduces or eliminates crankcase emissions
- ◆ improves cabin air quality <sup>(1)</sup>
- ◆ reduces engine oil consumption; and
- ◆ maintains a cleaner engine compartment

**Conclusion**

Donaldson's diesel engine know-how combined with its cutting edge crankcase blow-by characterization technology and Synteq XP media based Spiracle Systems offer the emissions reduction solutions that are needed by the diesel engine OEMs to meet worldwide emissions regulations.

### Reference:

- <sup>(1)</sup> Three independent studies concluded Spiracle CFS improves in-cab air quality. Links to studies can be found on Donaldson Emissions Resource Center at [www.donaldson.com/en/erc](http://www.donaldson.com/en/erc)

### Acronyms

OCV	Open Crankcase Vent/Ventilation
CCV	Closed Crankcase Vent/Ventilation
CFS	Crankcase Filtration System
OE	Original Equipment
OEM	Original Equipment Manufacturer
EPA	Environmental Protection Agency
ARB	Air Resources Board; California Air Resources Board
PM	Particulate Matter

### Internet Resources:

[www.donaldson.com/en/engine/crank/](http://www.donaldson.com/en/engine/crank/)

Donaldson, Spiracle, and Synteq XP are trademarks or registered trademarks of Donaldson Company, Inc.



<b>Donaldson Company, Inc.</b> PO Box 1299 Minneapolis, MN 55440-1299 <a href="http://www.donaldson.com">www.donaldson.com</a>	<b>North America</b> 866-511-7610 <b>Mexico</b> +52-449-910-6150 <b>Latin Am. &amp; Caribbean</b> +52-449-910-6150 <b>Brazil</b> +55-11-2119-1604 <b>Europe</b> +32-16-38-3811 <b>South Africa</b> +27-11-997-6000	<b>South East Asia</b> 65-6311-7373 <b>Greater China</b> 852-2405-8388 <b>Japan</b> 81-42-540-4112 <b>Australia</b> 61-02-4350-2033 <b>India</b> +91-124-2290060
--	---	--

Brochure No. F113025 (03/10)

© 2010 Donaldson Company, Inc. All rights reserved. Donaldson Company, Inc. reserves the right to change or discontinue any model or specification at any time and without notice. Printed in the U.S.A.



# AIR INTAKE FOR VEHICLES/EQUIPMENT APPLICATION DESIGN WORKSHEET



For proper development/design engineering solution, we ask you to provide details about your engine, project due dates, intake system and performance (mechanical and filtration), system mounting, service, final packaging and product markings.

When completed, please forward to Donaldson.  
Email: engine@donaldson.com

<b>Customer Name:</b>		<b>Revision:</b>
<b>Project Name:</b>		
<b>Contact Name:</b>		<b>Title</b>
<b>Phone:</b>	<b>Fax:</b>	<b>Email:</b>

<b>Current Donaldson Model Used: (if applicable)</b>	<b>Your Part Number:</b>
--	--------------------------

### Project Details

**Type of Machine:** \_\_\_\_\_

**Units Per Year:** \_\_\_\_\_

**Key Project Dates:**

Design Proposal: \_\_\_\_\_  
 Prototype Delivery: \_\_\_\_\_  
 Design Freeze: \_\_\_\_\_  
 PPAP: \_\_\_\_\_  
 Start of Production: \_\_\_\_\_

### Engine Information

**Manufacturer** \_\_\_\_\_

**Model** \_\_\_\_\_

**No of Cylinders** \_\_\_\_\_

**Rating** \_\_\_\_\_ hp/kw at \_\_\_\_\_ rpm

### External Requirements

**Dust Condition:**

Light     Medium     Heavy

Other Conditions:

High Carbon (soot)     Mist     Seed/Chaf

Other: \_\_\_\_\_

**Does this air cleaner need to be flame retardant?**

Yes     No

**Air Temperature:**

\_\_\_\_\_ ° C Engine Compartment  
 \_\_\_\_\_ ° C Max. Intake Air Temperature  
 \_\_\_\_\_ ° C Max. Temp. in close proximity to air cleaner

### Air Intake Requirements

**Airflow:** (Specify units, standard conditions if 20° C and 101.3 kPa, unless other specified.)

Maximum Rated with EGR \_\_\_\_\_

Maximum Rated with out EGR \_\_\_\_\_

Maximum Initial Restriction:  
 \_\_\_\_\_ (pressure) at \_\_\_\_\_ (flow rate)

Service Restriction Limit:  
 \_\_\_\_\_ (pressure) at \_\_\_\_\_ (flow rate)

**Pre-cleaner Scavange Available:**     Yes     No

**Type of Maintenance:**     Scheduled     Restriction

**Service Interval Desired:**

\_\_\_\_\_ hours OR miles

**Air Temperature:**

\_\_\_\_\_ ° C Engine Compartment  
 \_\_\_\_\_ ° C Max. Intake Air Temperature  
 \_\_\_\_\_ ° C Max. Air Cleaner Housing Skin Temp.

### Intake System Mounting Requirements

**Under Hood:**     Frame/Rail     Engine     Firewall  
 Other \_\_\_\_\_

**Outside of Engine Compartment**

Cowl Mounted     Frame/Rail  
 Other, please describe

**Location / Space Footprint:**

Limitations (include inches or metric)    Dia. \_\_\_\_\_

Length: \_\_\_\_\_    Inlet \_\_\_\_\_    Outlet \_\_\_\_\_

**Model of Space Envelope Attached?**     Yes     No



**Vibration**

PSD/Time History Data Attached  Yes  No

Natural Frequencies to avoid (engine fundamental, track/wheel/tire input): \_\_\_\_\_

What is B10 life? \_\_\_\_\_ hours or miles

Machine Axis	Acceleration (g) Max. G Load	Peak Shock Loads (g)	Expected No. of Cycles-Shock
Vertical			
Fore/Aft			
Side to Side			

**Intake Plumbing**

Describe any special intake ducting, clamp, or torque requirements.

**Outlet Plumbing**

Describe any special intake ducting, clamp, or torque requirements.

Clamp Torque Specification \_\_\_\_\_

Restriction Indicator Port?  Yes  No

Intake Air Temperature Sensor?  Yes  No

Mass Air Flow Sensor?  Yes  No

Crankcase Ventilation Port?  Yes  No

**Additional Fittings?**  Yes  No

If yes, describe (location, thread/seal type)

**Additional Information**

Is a safety/secondary filter required?

Yes  No

Flame retardant required?

Yes  No

Do you have any special finish requirements?

Yes  No

**Accessories**

Mounting Bands  Yes  No

Rain Caps / Hoods  Yes  No

Moisture Eliminators  Yes  No

Filter Indicators  Yes  No

**Packaging**

**Check all that apply?**

Protective caps:  on inlet  on outlet  on port

Other \_\_\_\_\_

Final Assembly:

Bulk  Individual Boxes  Returnable

Other \_\_\_\_\_

**Markings**

**Do you have any marking requirements?**

Intake Assembly?  Yes  No

Filters?  Yes  No

Pre-Cleaner?  Yes  No

**Installation & Service**

Do you require installation, service or maintenance recommendations from Donaldson?  Yes  No

**Additional Comments on Requirements?**

**For Donaldson USE ONLY**

Date Received: \_\_\_\_\_

Request From:  Catalog  Web Site  
 Other \_\_\_\_\_

Assigned to:

Business Unit: \_\_\_\_\_

Account Manager: \_\_\_\_\_

Product Manager: \_\_\_\_\_

Engineer: \_\_\_\_\_



Donaldson Company, Inc.  
PO Box 1299  
Minneapolis, MN 55440-1209  
  
Engine Air Intake  
Applications Engineering

Doc. No. F115348 Rev.0      October 2010  
© 2010 Donaldson Company, Inc. All rights reserved. Printed in the U.S.A.  
Donaldson Company, Inc. reserves the right to change or discontinue any model or specification at any time and without notice.

Donaldson Company, Inc., PO Box 1299, Minneapolis, MN 55440-1299



# ENGINE CRANKCASE FILTRATION APPLICATION DESIGN WORKSHEET



For proper development/design engineering solution, we ask you to provide details about your project, engine and crankcase parameters, performance (mechanical and filtration), system mounting, service, final packaging and product markings.

When completed, please forward to Donaldson.  
Email: [engine@donaldson.com](mailto:engine@donaldson.com)

<b>Customer Name:</b>		<b>Revision:</b>	
<b>Project Name:</b>			
<b>Contact Name:</b>		<b>Title</b>	
<b>Phone:</b>	<b>Fax:</b>	<b>Email:</b>	

<b>Current Donaldson Model Used: (if applicable)</b>	<b>Your Part Number:</b>
--	--------------------------

### Project Details

**Type of Machine:** \_\_\_\_\_  
**Units Per Year:** \_\_\_\_\_  
**Key Project Dates:**  
 Design Proposal: \_\_\_\_\_  
 Prototype Delivery: \_\_\_\_\_  
 Design Freeze: \_\_\_\_\_  
 PPAP: \_\_\_\_\_  
 Start of Production: \_\_\_\_\_

### Engine Information

Manufacturer \_\_\_\_\_  
 Model \_\_\_\_\_  
 Emissions regulations (U.S. EPA, Euro) being met?  
 \_\_\_\_\_  
 No of Cylinders \_\_\_\_\_  
 Engine Displacement \_\_\_\_\_ l  
 Rating \_\_\_\_\_ kW at \_\_\_\_\_ rpm  
 Number of Turbochargers \_\_\_\_\_  
 Oil Type/Grade \_\_\_\_\_  
 Height between housing oil exit to  
 oil pan \_\_\_\_\_ cm  
 Engine Tilt Requirements: Degree \_\_\_\_\_  
 Duration \_\_\_\_\_ Direction \_\_\_\_\_  
 Engine Compartment Temperature \_\_\_\_\_ °C

### Crankcase Design Parameters

Desired Crankcase Filtration System Type:  
 Open     Closed     Not Sure  
 Desired Filter Life: \_\_\_\_\_ hours or miles  
 Minimum crankcase filtration efficiency (%) \_\_\_\_\_  
 Maximum blow-by gas flow \_\_\_\_\_ l/min  
 Blow-by gas flow difference between new engine and old  
 engine \_\_\_\_\_ l/min  
 Blow-by gas flow rate at engine brake \_\_\_\_\_ l/min  
 Maximum temperature of blow-by gas \_\_\_\_\_ °C  
 Crankcase pressure range (kPa)  
 minimum: \_\_\_\_\_ maximum: \_\_\_\_\_  
 Pressure relief valve required?     Yes     No  
 Pressure regulation valve required?     Yes     No  
 Engine oil carry-over \_\_\_\_\_ g/h  
 Check valve on oil return line     Yes     No  
 Engine Air Cleaner Restriction (kPa)  
 Initial \_\_\_\_\_ Final \_\_\_\_\_

*continued on next page*

**Mounting Requirements**

**Location / Space Footprint:**

Limitations (include inches or metric) Dia. \_\_\_\_\_

Length: \_\_\_\_\_ Inlet \_\_\_\_\_ Outlet \_\_\_\_\_

**Model of Space Envelope Attached?**  Yes  No

**Vibration**

PSD/Time History Data Attached  Yes  No

Natural Frequencies to avoid (engine fundamental, track/wheel/tire input:) \_\_\_\_\_

What is B10 life? \_\_\_\_\_ hours or miles

Machine Axis	Acceleration (g) Max. G Load	Peak Shock Loads (g)	Expected No. of Cycles-Shock
Vertical			
Fore/Aft			
Side to Side			

**Additional Information**

Do you have any special finish requirements?

Yes  No

**Accessories**

Hoses  Yes  No

Clamps  Yes  No

Filter Indicators  Yes  No

**Packaging**

**Check all that apply?**

Protective caps:  on inlet  on outlet  on port

Other \_\_\_\_\_

**Final Assembly:**

Bulk  Individual Boxes  Returnable

Other \_\_\_\_\_

**Markings**

**Do you have any marking requirements?**

Assembly?  Yes  No

Filters?  Yes  No

**Installation & Service**

Do you require installation, service or maintenance recommendations from Donaldson?  Yes  No

**Additional Comments on Requirements?**

**For Donaldson USE ONLY**

**Date Received:** \_\_\_\_\_

**Request From:**  Catalog  Web Site  
 Other \_\_\_\_\_

**Assigned to:**

Business Unit: \_\_\_\_\_

Account Manager: \_\_\_\_\_

Product Manager: \_\_\_\_\_

Engineer: \_\_\_\_\_



Donaldson Company, Inc.  
PO Box 1299  
Minneapolis, MN 55440-1200

Engine Air Filtration  
Applications Engineering

Doc. No. F115356 Rev.1

January 2012

© 2012 Donaldson Company, Inc. All rights reserved. Printed in the U.S.A.  
Donaldson Company, Inc. reserves the right to change or discontinue any model or specification at any time and without notice.

## Engine Air Consumption & HP Rating Guide



The data on engines in this section is to be used as a reference only. If you are selecting a new air cleaner for an engine, Donaldson recommends that you acquire this information from the engine manufacturer. If this information is not available, we calculate the airflow based on instructions shown in the first section of this catalog.

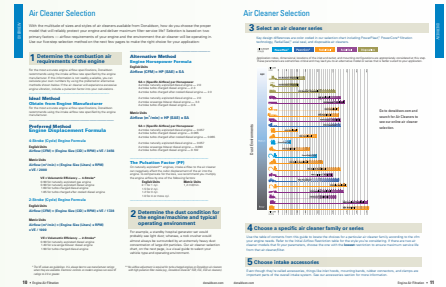

**DO NOT use this guide or data for the selection of retrofit emissions devices.**

- |                    |                      |            |
|--------------------|----------------------|------------|
| Allis Chalmers     | Kohler               | Renault    |
| Case               | Kubota               | Same       |
| Caterpillar        | Lister               | Teledyne   |
| Continental Motors | Lombardini           | Volkswagon |
| Cummins            | Mack                 | Volvo      |
| Detroit Diesel     | Mercedes-Benz        | Waukesha   |
| Deutz              | Mitsubishi           | White Eng  |
| Ford               | MTU of North America | Yanmar     |
| Hatz Diesel        | Navistar             |            |
| Hino               | Nissan               |            |
| Isuzu              | Perkins              |            |
| Iveco              |                      |            |
| John Deere         |                      |            |

For assistance in calculating engine airflow, please contact Donaldson customer service. See back cover for contact information.



Engine Model	RPM	HP	-- Exhaust --	
			Intake Temp. (°F)	Flow (CFM)
<b>ALLIS CHALMERS</b>				
10000	2200	145	265	
11000	2200	220	560	
16000	2100	250	420	
17000 MKII	2100	300	780	
2000	2100	59	97	
21000 MKII	2100	375	875	
213	3600	32	75	
2200	2100	55	97	
25000 MKII	2100	450	1050	
2800	2600	85	200	
2900	2600	135	340	
320	3600	53	114	
3400	2400	125	240	
3500	2400	175	380	
3700	2400	200	400	
426	3600	72	150	
433I	2400	100	247	
433T	2400	90	242	
6000	2200	104	218	
61000	2100	800	2300	
6138I	2100	450	1060	
6138LT	2100	325	790	
6138T	2100	375	875	
649I	2600	155	430	
649T	2600	135	390	
65000	2100	900	2400	
670I	2400	200	490	
670T	2400	175	460	
685I	2200	266	680	
685T	2200	220	555	
7000	2200	160	300	
D175	2200	52	85	
D262	2200	78	128	
D344	1800	88	143	

<b>CASE</b>					
301BD	2200	94	153	1000	414
336BD	2200	104	171	1000	462
336BDT	2200	126	267	850	648
451BD	2200	142	360	1000	973
451BDT	2200	181	380	900	957
504BD	2200	155	275	950	718
504BDT	2200	221	440	900	1108
504BDTI	2200	256	600	950	1567
A267D	2000	73	123	1000	333
A284	2000		136	1000	368
A377	1800		139	1000	376
A451D	2000	145	200	1000	541
G188	2000	49	82	1000	222
G188D	2250	62	138	1000	373

<b>CATERPILLAR</b>					
1160	2800	225	410	1050	1146
1673T	2200	250	600	950	1567
1674TA	2200	270	690	900	1738
1693TA	2100		1080	900	2720
3116	2600	200	618	856	1511
	2600	250	713	867	1755
	2450	275	685	929	1773
	2600	300	745	984	2006

Engine Model	RPM	HP	-- Exhaust --		
			Intake Temp. (°F)	Flow (CFM)	
3126B	2200	175	1239	660	2640
	2300	190	1355	716	3017
	2200	210	1327	741	3031
	2200	230	593	808	1471
	2200	250	635	821	1595
	2200	275	649	867	1683
	2200	300	660	916	1778
	2400	330	709	931	1937
3140	2800		410	1000	1109
3145	2800		410	1050	1146
3150	2800		410	1000	1109
3160	2800		410	1080	1169
3176	1800	275	692	676	1458
	1800	300	738	693	1579
	1800	350	802	760	1819
	1800	365	805	808	1900
3204NA	2400	66	193	980	515
3208ATAC	up to 300		950		
3208N	2200	165	325	1076	930
3208NA	2800	210	410	1000	1109
3208T	2800	250	646	900	1627
	2200	215	591	855	1443
3208T-DIATAAC					
	2600	275	752	854	1837
	2800	300	871	874	2162
3208T-DIT	2600	250	649	976	1740
3304B	up to 165		950		
3304NA	2200	102	206	1050	576
3304T	2200	165	264	900	665
3306	1900	300	745	1019	2059
3306B	1800	285	745	825	1781
	1800	300	777	843	1887
3306NA	2200	150	325	950	849
3306T	2200	250	600	900	1511
	up to 300		850		
3306TA	2200	270	624	950	1629
3406	1900	425	1109	880	2758
3406B	1800	300	930	655	1917
	1800	330	986	705	2125
	1800	350	1016	739	2255
	1800	400	1052	753	2364
	1800	425	1077	806	2532
	1900	460	1108	847	2694
3406E	1800	355	967	762	2301
	1800	375	1023	899	2717
	1800	435	1066	901	2872
	1800	455	1083	919	2925
	1800	475	1105	937	3017
	1800	500	1119	954	3098
	1800	575	1164	959	3236
	1800	600	1164	959	3236
3406T	2100	339	910	900	2292
3406TA	2100	375	1000	900	2519
3408T	2100	425	980	900	2468
3408TA	2100	475	1220	900	3073
3412T	2100	650	1719	870	4234
3412TA	2100	750	2426	900	6420
3508	1800	1000	2490	900	6271
3512	1800	1500	3695	900	9306
3516	1800	2000	4830	900	12164
3606	1000	2475	5850	850	14192
3608	1000	3330	7235	800	16882
3612	1000	4950	11700	800	27300
3616	1000	6655	14470	800	33763
5.4-6	2000	437	1041	950	2718
5.4-8	1900	614	1477	950	3857

Engine Model	RPM	HP	-- Exhaust --		
			Intake Temp. (°F)	Flow (CFM)	
5.4V12	1900	896	1936	900	4876
5.75-6	1330	317	780	950	2037
6.25-6	1375	440	1111	950	2901
C-10	1800	305	755	821	1888
	1800	335	766	918	2078
	1800	350	752	892	1997
	1800	370	766	918	2078
C-12	1800	335	805	876	2110
	1800	355	815	859	2121
	1800	380	826	898	2202
	1800	395	833	924	2265
	1800	410	836	937	2287
	1800	425	815	922	2220
	1800	430	826	948	2276
	1800	455	819	953	2269
C-15	1800	355	963	762	2294
	1800	375	1023	899	2714
	1800	435	1066	902	2830
	1800	455	1083	919	2925
	1800	475	1105	937	3017
	1800	500	1119	954	3098
C-16	1800	575	1154	941	3165
	1800	600	1164	959	3236
D330NA	2200	100	227	1050	635
D330T	2200	165	418	950	1091
D333NA	2200	150	349	1000	944
D333T	2200	250	613	900	1544
D334TA	2200	280	689	950	1799
D336TA	2200	350	895	950	2337
D342NA	1300	200	418	1050	1169
D342T	1300	300	887	950	2316
D343T	2000	315	786	950	2052
D343TA	2000	425	996	900	2508
D346TA	2000	565	1350	900	3400
D348TA	2000	850	2048	900	5158
D349TA	2000	1130	2827	900	7120
D353TA	1300	490	1091	900	2748
D379TA	1300	650	1501	900	3780
D398TA	1300	975	2323	900	5851
D399T	1300	1300	3009	900	7578

<b>CONTINENTAL MOTORS</b>					
E201	2400		104	1100	300
F124	2400		65	1100	188
F135	2000	40	58	1100	168
F140	2400		84	1100	243
F162	2400	60	84	1100	243
F186	2400		101	1100	292
F209	2400		109	1100	315
F226	2400		115	1100	332
F227	2400	78	116	1100	335
F244	2400		126	1100	364
F245	2400	88	127	1100	367
G134	2000		58	1100	168
G157	2000		68	1100	196
H227	2000		96	1100	277
H243	2000		104	1100	300
H260	2000		112	1100	324
J382	2000		160	1100	462
L478	2400	162	265	1100	766
M271	2400		141	1100	407
M290	2400		151	1100	436
M330	2400		172	1100	497
M363	2400	122	201	1100	581
N56	2200		27	1100	78
N62	2400		31	1100	90

Engine Model	RPM	HP	Intake CFM	-- Exhaust --	
				Temp. (°F)	Flow (CFM)
<b>CONTINENTAL MOTORS CONTINUED</b>					
R513	2400	267	1100	771	
R572	2400	298	1100	861	
R602	2400	191	313	1100	904
S749	2200	358	1100	1034	
S802	2200	392	1100	1132	
S820	2400	250	455	1100	1314
T&B371	2400	193	1100	558	
T&B427	2400	133	241	1100	696
U501	2400	260	1100	751	
V603	2800	313	1100	904	
Y112	2400	37	58	1100	168
Y69	2400	37	1100	107	
Y91	2400	27	91	1100	263

### CUMMINS

3B2.9	2500	56	115	1000	311
4B3.9	2500	76	150	1050	419
4BT	2500	105	289	890	750
4BT	2500	120	336	970	922
4BT3.9	2500	100	253	1000	684
4BT3.9-G1	1800	86	147	850	357
4BT3.9-G2	1800	102	157	850	381
4BTA3.9	2500	120	298	900	751
6B5.9	2500	116	226	1000	611
6BT	2500	190	590	780	1290
	2500	230	535	1031	1531
	2300	230	520	910	1380
6BT5.9	2500	152	381	900	960
6BT5.9-G1	1800	135	224	900	564
6BT5.9-G2	1800	166	285	900	718
6BTA5.9	2500	180	449	900	1131
6C8.3	2500	316	1000	854	
6CT	2300	250	570	930	1740
	2200	300	742	1000	2140
	2000	275	590	985	1665
6CT8.3	2500	555	900	1398	
6CTA8.3	2500	250	632	900	1592
C-160	2500	153	300	900	756
C-180	2500	173	350	900	881
C-190	2500	190	495	900	1247
FLEET 270	1600	270	710	900	1788
FLEET 300	1600	300	765	900	1927
	1600	300	710	900	1788
Formula 240	1800	240	630	900	1587
	1800	240	618	900	1556
Formula 270	1800	270	720	900	1813
Formula 300	1800	300	761	900	1917
	1800	300	745	900	1876
	1800	300	744	900	1874
Formula 315	1800	315	735	900	1851
Formula 350	1800	350	821	900	2068
	1800	350	800	900	2015
	1800	350	857	900	2158
Formula 400	1900	400	1060	900	2670
	1900	400	930	950	2428
	1900	400	986	900	2483
Formula 450	1900	450	1110	950	2898
Formula L10-240					
	1900	240	522	900	1315
	1900	240	580	900	1461
	1900	240	585	900	1473

Engine Model	RPM	HP	Intake CFM	-- Exhaust --	
				Temp. (°F)	Flow (CFM)
Formula L10-270					
	1900	270	556	900	1400
	1900	270	618	900	1556
	1900	270	606	900	1526
Formula L10-300					
	1900	300	609	900	1534
GNH-220-IP	1800	177	250	900	630
GNH-250-IP	1800	204	265	900	667
GV-12-525-IP	1800	408	580	900	1461
ISB	2500	185	578	698	1257
	2600	190	526	801	1250
	2500	205	508	831	1246
	2600	210	526	857	1313
	2500	225	510	892	1311
	2500	240	610	812	1456
	2500	245	610	812	1456
	2600	260	622	886	1592
	2500	275	620	956	1673
ISC	2400	225	708	706	1417
	2400	240	721	746	1485
	2400	260	743	765	1578
	2200	285	682	833	1531
	2200	300	688	860	1578
	2200	315	682	919	1686
	2200	330	693	927	1758
	2200	350	706	966	1841
ISL	2100	310	689	891	1682
	2100	330	708	933	1740
ISM	2100	280	777	670	1523
	1800	310	734	721	1528
	1800	330	773	742	1610
	2100	350	888	720	1778
	2100	370	918	737	1853
	2100	400	918	737	1853
	2100	425	855	969	2171
	2100	450	974	789	2030
	2100	500	940	965	2341
ISX	1800	400	1063	655	2036
	1800	450	1129	696	2218
	2000	475	1126	842	2504
	2000	500	1125	905	2633
	2000	600	1227	975	3202
KT-1150-C	2100	450	1130	900	2846
KT-2300-C	2100	900	2400	880	5956
KT-450	2100	450	1130	850	2741
KTA-1150-C	2100	600	1400	900	3526
	2100	525	1410	880	3499
KTA-2300-C	2100	1200	2900	900	7304
	2100	1050	2700	900	6800
KTA-3067-C	2100	1600	3760	900	9470
	2100	1350	3455	900	8701
KTA-525	2100	525	1425	850	3457
KTA-525-FORM					
	1900	525	1200	850	2911
KTA-600	2100	600	1400	850	3396
KTTA-19-C		650		900	
KTTA-38-C		1350		900	
KTTA-50-C		2000		900	
L10	1700	260	615	745	1300
	1700	280	640	760	1407
	1600	310	638	825	1470
	2100	270	670	900	1687
	2100	300	659	900	1660

Engine Model	RPM	HP	Intake CFM	-- Exhaust --	
				Temp. (°F)	Flow (CFM)
M11	1600	280	615	817	1476
	1600	310	670	813	1390
	1600	350	760	822	1554
	1600	370	770	828	1641
	1600	400	840	832	1801
N-855-C	2100	220	460	850	1116
	2100	235	460	850	1116
N-927	1950	240	465	880	1154
	2100	260	495	880	1228
	2100	240	495	880	1228
N14	1800	330	1014	657	1997
	1800	400	1126	723	2354
	2100	350	1212	606	2254
	2100	370	1283	651	2474
	2100	460	1329	737	2737
	2100	500	1380	802	2984
	2100	525	1380	802	2984
	2100	410	1164	670	2614
	2100	435	1302	714	2639
	2100	550	1380	802	2984
	2100	525	1380	802	2984
NH-220	2100	212	470	900	1184
NH-230	2100	220	460	900	1159
NH-230S	1800	186	460	900	1159
NH-250-M	2100	240	460	950	1201
	1800	190	395	1050	1105
	1800	200	395	900	995
	2100	210	460	900	1159
NHC-250	2100	240	460	900	1159
	2300	240	710	900	1788
NHC-250-D	2100	240	460	900	1159
NHD-230	2100	220	495	900	1247
NHF-240	2300	230	505	900	1272
NHF-265	2300	255	505	900	1272
NHH-250	2100	240	460	900	1159
NHHTC-335	2100	335	850	850	2062
NHTF-295	2300	295	710	900	1788
NT-335-M	1800	235	625	950	1632
	1800	265	650	900	1637
	2100	285	775	950	2024
	2100	335	800	950	2089
NT-380-M	2300	380	950	950	2481
	2000	253	700	1000	1893
	2000	300	750	900	1889
	2300	320	900	980	2400
NT-855-C	2100	310	895	880	2221
	2100	280	860	850	2086
	2100	250	825	850	2001
	2100	335	920	900	2317
	2100	335	900	900	2267
	2100	280	820	900	2065
	2100	250	680	880	1687
	2100	310	835	900	2103
NTA-370	1950	335	810	850	1965
	2100	370	950	850	2305
NTA-400	2100	400	1000	850	2426
NTA-420	2300	420	1080	900	2720
NTA-855-C	2100	400	1000	880	2481
	2100	360	960	880	2382
	2100	360	980	900	2468
	2100	400	1050	900	2644
NTC-270-CT	2100	240	740	850	1795
	2100	225	760	900	1914
	2100	270	825	900	2078

Engine Model	RPM	HP	-- Exhaust --		
			Intake CFM	Temp. (°F)	Flow (CFM)
<b>CUMMINS CONTINUED</b>					
NTC-290	2100	270	665	950	1736
	2100	290	685	900	1725
	1950	255	580	920	1482
NTC-300	2100	300	936	900	2357
NTC-335	2100	280	780	880	1936
	2100	300	805	880	1998
	2100	335	850	900	2141
NTC-350	2100	320	830	900	2090
	2100	350	885	900	2229
	2100	335	865	880	2146
NTC-400	2100	320	845	880	2097
	1950	310	760	850	1844
	2100	350	986	900	2483
NTCC-300	2100	350	930	900	2342
	2100	400	1165	950	3042
	2100	400	1030	900	2594
NTCC-350	2100	300	868	900	2186
NTCC-400	2100	350	1000	900	2519
NTCC-400	2100	400	1090	900	2745
NTF-295	2300	295	710	850	1722
NTF-365	2300	365	960	920	2453
P.TORQ 240	2100	240	618	900	1556
P.TORQ 270	2100	240	735	900	1851
	2100	270	840	900	2116
P.TORQ 315	2100	315	890	950	2324
	<b>P.TORQ L10-240</b>				
	2100	240	645	900	1624
P.TORQ L10-240	2100	240	577	900	1453
	2100	240	647	900	1629
	<b>P.TORQ L10-270</b>				
Signature	2100	270	630	900	1587
	2000	500	1072	959	2638
	2000	565	1117	986	2777
SUPER 250	2000	600	1164	1013	2936
	2100	240	495	900	1247
	V-12-500-M	2100	480	840	900
1800		370	720	950	1880
1800		400	720	900	1813
V-378-C	2100	425	840	950	2193
	3000	145	277	900	698
	3000	195	357	900	899
V-504-C	3300	202	425	950	1110
	2500	158	322	900	811
	3300	197	386	900	972
V-555	3300	216	470	880	1166
	3000	215	430	850	1043
	3300	202	470	900	1184
V-555-C	2600	307	610	900	1536
	2600	255	610	900	1536
	2600	269	610	900	1536
V-555-E	2600	288	610	880	1514
	2600	295	610	880	1514
	2600	265	610	850	1480
V-903	2600	307	610	950	1593
	2300	250	545	900	1373
	2500	302	585	900	1473
V-903-M	2200	250	520	880	1290
	1800	435	1060	900	2670
	<b>V5-120-635-M</b>				
V5-120-635-M	2100	540	1380	900	3476
	3300	149	318	950	830
	3300	178	425	950	1110
V8-185-E	3300	202	425	950	1110
V8-210	3300	202	425	950	1110

Engine Model	RPM	HP	-- Exhaust --		
			Intake CFM	Temp. (°F)	Flow (CFM)
V8-300	3000	288	580	970	1536
V8-300-M	3000	288	585	950	1528
	2600	220	505	900	1272
	2800	260	545	950	1423
<b>VT-12-635-M</b>					
VT-12-635-M	2100	635	1460	950	3812
	1800	490	1100	900	2770
<b>VT-12-700-M</b>					
VT-12-700-M	2100	700	1600	980	4267
	1800	480	1130	900	2846
	1800	545	1190	900	2997
VT-12-800-M	2100	595	1500	950	3917
	2100	800	1820	950	4752
	1800	550	1325	900	3337
VT-1710-C	1800	620	1400	900	3526
	2100	680	1700	950	4439
	2100	635	1700	900	4281
VT-555	3000	220	625	900	1574
VT-555-C	3000	230	585	850	1419
VT-903	2600	307	850	900	2141
	2600	350	1050	900	2644
	2600	320	930	900	2342
VT-903-C	2600	350	920	900	2317
	2600	320	905	900	2279
	3000	370	930	950	2428
VT8-370-M	2600	270	760	900	1914
	2800	320	865	950	2259
	2100	700	1880	950	4909
VTA-1710-C	2100	800	2100	980	5600
	900			900	
<b>VTR-28-C</b>					
<b>DETROIT DIESEL</b>					
12V-149	1900	800	2800	850	6793
12V-149T	1900	1000	3600	850	8733
12V-149TI	1900	1200	4300	850	10431
12V-71	1800	350	1128	850	2736
	2300	471	1430	850	3469
	2100	456	1309	850	3176
12V-71T	2100	525	1800	850	4367
	1800		1650	850	4003
16V-149	1900	1060	3600	850	8733
16V-149T	1900	1325	4800	850	11644
16V-149TI	1900	1600	5500	850	13343
16V-71	2100	608	1748	850	4241
	1800	466	1506	850	3653
	1800		2240	850	5434
16V-71T	2100	700	2300	850	5580
	1800	600	1960	850	4755
16V-92	2100	720	2300	850	5580
	2100	860	3200	850	7763
	1800		2600	850	6307
2-53	1800		130	850	315
	1200		91	850	221
	200		142	850	344
2-71	200	65	223	850	541
	1800	48	200	850	485
	1200		131	850	318
3-53/2-VAL	2200	75	242	850	587
	1800	59	202	850	490
	2200		253	850	614
3-53T	2800	98	319	850	774
	2500	125	500	850	1213
	2500	125	500	850	1213
3-71	1800	82	319	850	774
	2100	109	375	850	910
	1200		207	850	502

Engine Model	RPM	HP	-- Exhaust --		
			Intake CFM	Temp. (°F)	Flow (CFM)
4-35T	2500	170	596	850	1446
4-53/2-VAL	2200	103	340	850	825
	1000		282	850	684
	2200		356	850	864
4-53T	2800	136	450	850	1092
	2500	170	596	850	1446
	1200		275	850	667
6-71	2300	159	550	850	1334
	1800	117	425	850	1031
	2100	152	500	850	1213
6-71T	2300	236	825	850	2001
	1800	175	637	850	1545
	2100	228	750	850	1819
6-71T	1200		413	850	1002
	2100	275	1045	850	2535
	1950	230	930	850	2256
6-V-71	2300	236	715	850	1735
6V-53	1800	175	564	850	1368
	2100	228	655	850	1589
	2200		534	850	1295
6V-53T	2800	210	675	850	1638
	2600		627	850	1521
	2500	230	855	850	2074
6V-92	1800	225	730	850	1771
	2100	270	860	850	2086
	1800		1000	850	2426
6V-92T	2100	322	1200	850	2911
	2100	335	1225	850	2972
	1950		1030	850	2499
6V-92TT	1950	270	1050	850	2547
6V-92TTA	1950	270	1050	850	2547
8.2LN	3000	165	376	850	912
8.2LT	3000	205	553	850	1342
8V-53	2200		693	850	1681
	2500		786	850	1907
	1800	233	753	850	1827
8V-71	2300	314	954	850	2314
	2100	304	874	850	2120
	2100	350	1200	850	2911
8V-71T	1800		1100	850	2669
	2100	370	1240	850	3008
	1950		1240	850	3008
8V-71TA	1950	305	1055	850	2559
8V-71TT	1950	305	1055	850	2559
8V-92	1800	300	980	850	2377
	2100	360	1150	850	2790
	2100	430	1600	850	3881
8V-92T	1800		1300	850	3154
	2100	435	1434	850	3479
	1950		1300	850	3154
8V-92TT	1950	365	1250	850	3032
<b>Series 40E (7.6 LTA)</b>					
Series 40E (7.6 LTA)	2300	175	675	670	1450
	2600	190	705	710	1575
	2600	210	740	765	1730
	2600	230	700	885	1810
	2400	195	715	720	1610
Series 40E (8.7 LTA)	2400	250	700	885	1810
	2200	250	685	850	1725
	2200	275	705	955	1890
2200	300	710	965	1930	
2200	320	715	985	1995	

Engine Model	RPM	Intake HP	Intake CFM	-- Exhaust --	
				Temp. (°F)	Flow (CFM)
<b>DETROIT DIESEL CONTINUED</b>					
Series 50 (8.5 Ltr)					
2100	250	760	625	1575	
2100	275	790	680	1720	
2100	300	820	715	1845	
2100	320	815	730	1861	
2100	350	815	850	2055	
Series 60 (12.7 Ltr)					
2100	330	1050	610	2157	
2100	350	1090	645	2310	
2100	370	1010	725	2300	
2100	400	1050	780	2500	
2100	430	1080	820	2652	
2100	470	1170	825	2877	
2100	500	1170	825	2877	
Series 60 (14 Ltr)					
2100	550	1231	986	3402	
2100	575	1271	867	3221	

### DEUTZ

BF12L 714	2300	390	695	850	1686
BF6L 913	2800	175	396	850	961
F10L 413	2650	310	595	850	1443
F10L 714	2300	275	577	850	1400
F12L 413	2650	370	714	850	1732
F12L 714	2300	330	695	850	1686
F1L 208	3600	9	70	850	170
F1L 210	3000	16	96	850	233
F1L 411D	3000	16	98	850	238
F2L 411D	3000	32	133	850	323
F2L 411W	3000	30	133	850	323
F2L 912	2500	36	150	850	364
F2L 912W	2500	34	150	850	364
F3L 912	2800	60	176	850	427
F3L 912W	2500	50	158	850	383
F4L 912	2800	80	202	850	490
F4L 912W	2500	67	180	850	437
F5L 912	2800	100	210	850	509
F5L 912W	2500	84	187	850	454
F6L 413	2650	185	357	850	866
F6L 714	2300	165	347	850	842
F6L 912	2800	120	252	850	611
F6L 912W	2500	101	224	850	543
F8L 413	2650	250	476	850	1155
F8L 714	2300	220	463	850	1123

### FORD

00	2400	59	101	900	254
172DF	2400	59	101	900	254
175DF	2500	52	108	900	272
183D	2200	52	99	900	249
192DF	2400	65	113	900	285
201DF	2250	66	111	900	280
220	2400	69	130	900	327
233D	2100	68	120	900	302
242D	2230	76	133	900	335
242DF	2500	79	149	900	375
254DF	2500	80	157	900	395
256DF	2500	89	157	900	395
3320DF	2500	111	203	900	511
362DF	2500	121	223	900	562
363DFT	2400	150	214	900	539
380DF	2500	120	233	900	587
401DF	2500	132	246	900	620
401DFT	2500	167	246	900	620

Engine Model	RPM	Intake HP	Intake CFM	-- Exhaust --	
				Temp. (°F)	Flow (CFM)
67GF	3600	32	60	900	151
98GF	3600	45	87	900	219
X	2250	60	122	900	307
Y	2250	96	183	900	461

### HATZ DIESEL

2L30	3000	30	68	1100	196
2L40	3000	37	82	1100	237
2M40	3000	40	85	1100	246
3L30	3000	45	101	1100	292
3L40	3000	55	123	1100	355
3M40	3000	60	130	1100	376
4L30	3000	60	135	1100	390
4L40	3000	74	164	1100	474
4M40	3000	80	170	1100	491
E573	3000	3	14	1100	40
E673	3000	5	16	1100	46
E75	3000	7	18	1100	52
E780	3000	10	25	1100	72
E786	3000	14	30	1100	87
E79	3000	8	20	1100	58
E88	2600	10	28	1100	81
E89	2600	12	30	1100	87
E950	3000	17	36	1100	104
Z788	3000	23	55	1100	159

### HINO

Z790	3000	30	61	1100	176
DK10	2000	132	325	900	819
DK10T	1800	160	425	900	1070
DM100	2400	62	165	900	416
EB300	2000	132	315	900	793
EC100	2600	76	208	900	524
EF550	2200	230	572	900	1441
EF750	2200	245	589	900	1483
EF750T	2200	272	850	900	2141
EH100	2600	93	244	900	615
EH500	2800	114	277	900	698
EH700	2800	118	290	900	730
EK100	2200	196	467	900	1176
EL100	2600	132	327	900	824
EL100T	2400	145	440	900	1108
EM100	2400	148	362	900	912
ER100	2200	160	407	900	1025
EV700	2200	298	700	900	1763

### ISUZU

QD100	3200	87	185	900	466
QD130	2800	115	230	900	579
QD145	3200	129	280	900	705
QD145T	2500	139	305	900	768
QD200	2200	194	410	900	1033
QD200T	2000	218	515	900	1297
QD27	2800	26	50	900	126
QD40	2800	40	80	900	201
QD60	3800	55	140	900	353
QD85	3000	68	162	900	408
QD90	2800	75	150	900	378
QT15	3600	14	55	900	139
QT23	3600	22	75	900	189
QT35	3000	32	96	900	242

Engine Model	RPM	Intake HP	Intake CFM	-- Exhaust --	
				Temp. (°F)	Flow (CFM)

### IVECO

803 i 3L-NA	2500	51	120	1100	347
804 i 4L-NA	2500	68	155	1100	448
805 i 5L-NA	2500	84	74	1100	214
806 i 6L-NA	2500	102	235	1100	679
806 i tc 6L-TC	2500	131	340	900	856
8210 i 6L-NA	2000	205	440	1100	1271
8280 i V8-NA	2200	287	600	1100	1733
8281 SRi V8-TCA	2200	424	900	900	2267
8281 Si V8-TC	2000	331	790	900	1990
8361 Si 7L-TC	2400	157	450	900	1133
8361 i 6L-NA	2500	139	322	1100	930

### JOHN DEERE

3164D	2500	52	100	900	252
3179D	2500	58	100	900	252
3179T	2500	79	178	900	448
4219D	2500	70	135	900	340
4239A	2500	117	277	900	698
4239D	2500	80	148	900	373
4239T	2500	109	258	900	650
4276D	2500	82	160	900	403
4276T	2200	98	266	900	670
6076A	2200	240	568	900	1431
6076H	2200	250	647	900	1629
6076T	2200	190	505	900	1272
6329D	2500	104	200	900	504
6359A	2500	176	470	900	1184
6359D	2500	121	228	900	574
6359T	2500	163	370	900	932
6414D	2200	118	228	900	574
6414T	2200	146	360	900	907
6466A	2100	233	579	900	1458
6466D	2200	138	258	900	650
6466T	2200	185	484	900	1219
6619A	2100	301	680	900	1713
8955A	2100	456	1130	900	2846
8955T	2100	356	978	900	2463

### KOHLER

K161	3600	7	14	1150	42
K181	3600	8	16	1150	48
K241	3600	10	20	1150	60
K301	3600	12	24	1150	72
K321	3600	14	26	1150	78
K341	3600	16	30	1150	89
K582	3600	23	48	1150	143
K91	3600	4	7	1150	21
KT17	3600	17	35	1150	104
KT19	3600	19	39	1150	116



Engine Model	RPM	Intake HP	-- Exhaust --	
			Temp. (°F)	Flow (CFM)

KUBOTA					
D1402-B	2800	31	62	900	156
D3200-B	2400	66	123	900	310
D600-B	3600	16	35	900	88
DH850-BW	3000	20	41	900	103
DH850-B	3600	23	49	900	123
S2800-B	2600	58	116	900	292
V1100-B	3000	26	55	900	139
V1702-B	2800	40	77	900	194
V1902-B	2800	42	83	900	209
V4300-B	2400	88	164	900	413
VH1100-B	3600	31	66	900	166
Z400-B	3600	11	23	900	58
Z600-BW	3200	14	29	900	73
ZB400-B	3200	10	21	900	53
ZB600C-1-B	3200	14	29	900	73
ZH600-B	3600	16	33	900	83

LISTER					
HL3	2500	125	900	315	
HL4	2500	167	900	421	
HL6	2500	250	900	630	
HLT6	2100	300	900	756	
HR2	2200	73	900	184	
HR3	2200	110	900	277	
HRW2	2200	31	74	900	186
HRW3	2200	47	110	900	277
HRW4	2200	62	146	900	368
HRW6	2200	93	220	900	554
HRWS6	2000	102	200	900	504
LT1	3600	8	24	900	60
LV1	3600	9	28	900	71
LV2	3600	18	55	900	139
ST1	3000	10	31	900	78
TL2	3000	27	74	900	186
TL3	3000	40	111	900	280
TS2	3000	22	61	900	154
TS3	3000	33	91	900	229

LOMBARDINI					
10LD 400-2	3000	16	34	1000	92
10LD 400-2/B1	3600	18	41	1000	111
11LD 535-3	3000	33	74	1000	200
11LD 625-3	3000	38	84	1000	227
3LD 450	3000	10	20	1000	54
3LD 510	3000	11	22	1000	59
3LD 510/L	2200	8	17	1000	46
4LD 640	3000	14	28	1000	76
4LD 640/L	2200	10	22	1000	59
4LD 705	2600	15	27	1000	73
4LD 820	2600	18	32	1000	87
4LD 820/L	2200	14	27	1000	73
5LD 675-2	3000	29	58	1000	157
5LD 675-3	3000	44	87	1000	235
5LD 825-2	2600	34	63	1000	170
5LD 825-2/L	2200	27	53	1000	143
5LD 825-3	2600	52	94	1000	254
5LD 825-3/L	2200	40	80	1000	216
5LD 825-4	2600	67	125	1000	338
5LD 825-4/L	2200	54	106	1000	287
5LD 930-3	2600	54	105	1000	284
5LD 930-4	2600	72	140	1000	379
6LD 260	3600	5	15	1000	41
6LD 260/C	1800	5	14	1000	38

Engine Model	RPM	Intake HP	-- Exhaust --	
			Temp. (°F)	Flow (CFM)

6LD 325	3600	7	17	1000	46
6LD 325/C	1800	7	17	1000	46
6LD 360	3600	8	19	1000	51
6LD 360 V	3600	8	19	1000	51
6LD 400	3600	8	21	1000	57
7LD 665	3000	15	29	1000	78
7LD 665/F	3000	15	29	1000	78
7LD 740/l	3000	16	32	1000	87
8LD 600-2	3000	26	52	1000	141
8LD 665-2	3000	29	58	1000	157
8LD 665-2/L	2200	22	44	1000	119
8LD 740-2	2600	29	52	1000	141
9LD 561-2	3000	26	48	1000	130
9LD 561-2/L	2200	18	37	1000	100

MACK					
E6	NA	350	NA	750	1950
E7	NA	300	NA	728	1561
	NA	350	NA	742	1679
	NA	400	NA	791	1934
	NA	427	NA	795	2136
	NA	460	NA	814	2315
	NA	310/330	NA	728	1550
	NA	330/355	NA	735	1653
	NA	355/380	NA	736	1767
E9	NA	500	NA	740	3050
EN291	2800	178	900	448	
EN331	2800	206	900	519	
EN402	2800	246	900	620	
EN438	2600	247	900	622	
EN540	2400	280	900	705	
EN707C	2100	306	900	771	
END465	2600	325	900	819	
END475	2400	280	900	705	
END5673C	2100	250	600	900	1511
END5864	2300	270	850	900	2141
END673E	2100	180	400	900	1007
END707	2100	200	410	900	1033
END864BC	2450	540	900	1360	
ENDT475	2400	460	900	1159	
ENDT673	2100	225	600	900	1511
ENDT675	2100	237	625	900	1574
ENDT676	800	900	2015		
ENDT864A	2300	860	900	2166	
ENDT865	2600	325	960	900	2418
ENDT866	2400	275	1050	900	2644
ENDTF673	2300	665	900	1675	
ENDTF673C	2200	625	900	1574	

MERCEDES-BENZ					
OM314	2800	85	170	900	428
OM346	2800	427	900	1075	
OM352	2800	130	260	900	655
OM352A	2800	168	336	900	846
OM355	2000	200	327	900	824
OM360	2500	190	308	900	776
OM401	2500	195	340	900	856
OM402	2500	260	340	900	856
OM403	2500	325	463	900	1166
OM404	2500	430	738	900	1859
OM407	2200	240	480	900	1209
OM407A	2200	280	560	900	1410
OM407h	2200	240	480	900	1209
OM407hA	2200	280	560	900	1410
OM421	2300	216	432	900	1088

Engine Model	RPM	Intake HP	-- Exhaust --	
			Temp. (°F)	Flow (CFM)

OM422	2300	280	560	900	1410
OM422A	2300	330	660	900	1662
OM422LA	2300	375	750	900	1889
OM423	2300	355	710	900	1788
OM423LA	2100	470	940	900	2367
OM424	2300	420	840	900	2116
OM424A	2300	530	1060	900	2670
OM424LA	2300	615	1230	900	3098
OM616	3600	67	134	900	337
OM617	3600	82	164	900	413
OM636	3500	40	95	900	239

MITSUBISHI					
S12A-PT	1800	660	1620	900	4080
S12A-PTA	1800	850	2080	900	5239
S12A-PTK	1800	900	2190	900	5516
S12N-PT	1800	1000	2440	900	6145
S12N-PTA	1800	1130	2750	900	6926
S12N-PTK	1800	1230	3000	900	7556
S12U-PTA	1200	3100	7910	900	19921
S12U-PTK	1200	3300	8400	900	21156
S16N-PT	1800	1320	3210	900	8084
S16N-PTA	1800	1500	3670	900	9243
S16N-PTK	1800	1620	3960	900	9973
S6A-PT	1800	330	810	900	2040
S6A-PTA	1800	425	1020	900	2569
S6A-PTK	1800	450	1100	900	2770
S6B-PT	1800	260	640	900	1612
S6B-PTA	1800	320	780	900	1964
S6B-PTK	1800	360	880	900	2216
S6N-PT	1800	500	1240	900	3123
S6N-PTA	1800	565	1380	900	3476
S6N-PTK	1800	615	1480	900	3727
S6U-PTA	1200	1550	3960	900	9973
S6U-PTK	1200	1650	4200	900	10578
S8N-PT	1800	660	1620	900	4080
S8N-PTA	1800	750	1840	900	4634
S8N-PTK	1800	810	1980	900	4987

MTU OF NORTH AMERICA					
12V-396-TB-83	1845	1560	3919	.....	3338
12V-396-TB-93	1845	1200	4534	.....	3862
12V-396-TC-82	1745	1300	2902	.....	2472
8V-396-TB-83	1845	1050	2436	.....	2075
8V-396-TB-93	1845	1800	2944	.....	2508
8V-396-TC-82	1745	870	1864	.....	1588

NAVISTAR					
4-196	3800	86	162	1150	483
6.9 L	3000	170	330	1000	892
7.3 LT (T444)	2600	190	605	753	1359
7.3 L	3000	175	349	1000	944
9.0 L (DV550)	2800	185	410	1050	1146
C-200	2500	74	109	1150	325
C-221	2600	90	124	1150	370
C-263	2800	109	160	1150	477
C-301	2800	118	183	1150	546
C-345	3000	160	224	1150	668

Engine Model	RPM	HP	Intake CFM	-- Exhaust --	
				Temp. (°F)	Flow (CFM)
<b>NAVISTAR CONTINUED</b>					
C-392	3000	180	255	1150	760
C-549	3200	232	381	1150	1136
C135B	2400	46	70	1150	209
C153	2400	53	80	1150	239
C175	2500	63	95	1150	283
D155	2500	48	95	900	239
D179	2400	59	99	900	249
D188	2400	62	104	900	262
D206	2500	56	119	900	300
D236	2400	65	131	900	330
D239	2500	80	138	900	348
D268	2500	85	165	900	416
D282	2400	95	156	900	393
D310	2300	101	165	900	416
D312	3000	117	216	900	544
D360	3000	136	250	900	630
D370	2200	105	188	900	473
D407	2600	127	245	900	617
D414	3000	157	287	900	723
D466	3000	165	323	900	813
D550B	3000	200	382	900	962
D554	2300	150	294	900	740
D691	1600	150	256	900	645
DT239	2500	110	225	900	567
DT358	2400	130	340	900	856
DT360	2700	190	588	850	1426
DT361	2600	146	341	900	859
DT402	2400	165	380	900	957
DT407	2500	160	368	900	927
DT414	3000	220	449	900	1131
DT420	2600	225	403	900	1015
DT466	2400	195	664	737	1520
DT466	2400	210	650	765	1530
DT466	2400	230	677	855	1710
DT466	2400	250	650	845	1640
DT466	2400	275	650	984	1820
DT573	2600	300	539	900	1357
DT573B	2600	260	525	900	1322
DT817	2100	385	975	900	2456
DT817B	2100	320	975	900	2456
DT817C	2200	420	975	900	2456
DVT800	2600	310	752	900	1894
MV-404	3600	188	315	1150	939
MV-446	3600	235	348	1150	1038
UC60	2500	17	33	1150	98
UR-450	2400	158	234	1150	698
UV-401	2800	165	243	1150	725
V-304	4400	180	298	1150	888
V-345	3800	172	284	1150	847
V-345	3800	168	284	1150	847
V-392	3600	236	306	1150	912
V-537	3200	208	372	1150	1109
VS-478	3400	224	352	1150	1049
VS-549	3200	243	381	1150	1136

### NISSAN

A-12	4800	58	74	900	186
A-15	4800	78	95	900	239
ED-33	3200	83	168	900	423
FD-33T	3200	105	235	900	592
FD-6	2700	131	243	900	612
FD-6T	2700	148	340	900	856
H-20	3100	55	82	900	207
H-30	2600	66	102	900	257

Engine Model	RPM	HP	Intake CFM	-- Exhaust --	
				Temp. (°F)	Flow (CFM)
J-15	2800	32	55	900	139
LD-20	2600	38	80	900	201
LD-28	2600	53	115	900	290
ND-6	2400	130	260	900	655
P-40	2300	80	120	900	302
PD-6	2200	173	360	900	907
PD-6T	2200	227	505	900	1272
PE-6	2200	200	408	900	1028
PE-6T	2200	250	570	900	1436
RD10	2400	330	682	900	1718
RD10T	2400	415	1000	900	2519
RD10TA	2300	485	1200	900	3022
RD8	2400	265	545	900	1373
RD8T	2400	320	763	900	1922
SD-16	3200	36	85	900	214
SD-22	3200	51	110	900	277
SD-25	3200	60	126	900	317
SD-33	3200	79	165	900	416
SD-33T	3200	92	230	900	579

### PERKINS

3.1522	2500	44	95	900	239
4-107	4000	57	99	900	249
4-108	4000	60	100	900	252
4-154	3600	80	128	900	322
4-203	2600	63	122	900	307
4-236	2800	80	153	900	385
4-248	2500	85	144	900	363
4-270	2000	62	125	900	315
4-300	2200	90	152	900	383
4-302	2300	76	161	900	405
4-318	2000	75	147	900	370
4-99	4000	55	92	900	232
4.108	4000	49	102	900	257
4.165	3600	70	135	900	340
4.2032	2250	58	117	900	295
4.236	2800	82	157	900	395
4.248	2500	84	152	900	383
4.318	2000	70	140	900	353
6-305	2600	89	184	900	463
6-354	2800	120	230	900	579
6-372	2500	121	215	900	541
6.247	3600	101	205	900	516
6.3544	2800	200	238	900	599
6.3724	2500	200	227	900	572
D3-152	2500	52	88	900	222
D3.152	2500	49	3	900	8
D4.203	2500	200	3	900	8
T6-354	2400	150	307	900	773
T6-354-3	2500	140	320	900	806
T6.3544	2600	200	370	900	932
TV8.640	2600	685	1725	900	1725
V8-510	2800	185	331	900	834
V8-540	2500	166	312	900	786
V8-605	2500	200	350	900	881
V8.540	2600	200	370	900	932
V8.640	2600	200	411	900	1035

### RENAULT

18TS/GTS	5750	92	230	1150	686
20 TL/GTL	5500	98	200	1150	596
20 TX	5500	112	230	1150	686
20 TX	5000	112	230	1150	686
4 GTL	4000	33	70	1150	209
4L/TL	4250	20	40	1150	119

Engine Model	RPM	HP	Intake CFM	-- Exhaust --	
				Temp. (°F)	Flow (CFM)
9 TD/GTD	4800			900	
FUEGO TURBO D	4250	85	211	900	531
TRAFIC	4750	46	90	1150	268
TRAFIC	5000	46	90	1150	268
TRAFIC PROP	4000	56	140	900	353

### SAME

1052 LP	2500	39	83		71
1053 P	2500	64	124		106
1054 P	2500	85	165		141
1054 PT	2300	90	152		129
1055 P	2500	105	206		175
1056 P	2500	126	248		211
1056 PS	2300	148	228		194
1056 PT	2300	160	228		194
916.3A	3000	61	131		112
916.4A	3000	81	175		149

### TELEDYNE

ACN	3600	6	13		11
AENL	3600	9	20		17
AGND	3200	12	26		22
BKN	3600	7	16		14
EY18-3W	3600	5	10		9
EY21W	3800	17	33		28
EY25W	3600	6	15		13
EY27W	3600	8	16		14
EY44W	3600	10	22		19
NH4D	2800	30	75		64
R08	5000	27	60		51
R11	4200	34	73		62
R14	4200	48	105		89
R17	5000	83	180		153
R22	5500	101	220		187
RD16	4800	54	135		115
RD21	4200	62	155		132
S-12D	3600	12	31		26
S-14D	3600	14	30		26
S-8D	3600	8	18		15
TJD	3600	18	48		41
TM13	3000	33	70		60
TM13	3000	22	45		38
TM20	3000	52	100		85
TM20	3000	44	90		77
TM27	3000	69	125		106
TM27	3000	59	120		102
TMD13	3000	29	72		61
TMD20	3000	44	110		94
TMD27	3000	121	300		256
TRA-12D	3600	12	25		21
V-465D	3000	66	133		113
V460D	3000	65	133		113
VE4	2400	48	110		85
VF4	2400	56	120		94
VG4D	2400	37	75		64
VH4	2800	61	130		94
VH4D	2800	30	65		55
VR4D	2200	37	122		104
W2-1230	3600	25	55		47
W2-1235	3600	30	68		58
W2-880	3600	20	44		37
W4-1770	3000	35	72		61
WD1-340	3000	7	18		15

Engine Model	RPM	HP	-- Exhaust --	
			Intake Temp. (°F)	Flow (CFM)

**TELEDYNE CONTINUED**

WD1-350.....3000.....8.....20.....17
WD1-430.....3000.....10.....24.....20
WD1-450.....3400.....10.....26.....22
WD1-660.....3000.....15.....38.....32
WD1-670.....3000.....16.....40.....34
WD1-750.....3000.....17.....43.....37
WD2-1000.....3000.....21.....52.....44
WD2-860.....3000.....19.....48.....41
WI-145.....4000.....4.....8.....7
WI-145V.....3600.....4.....8.....7
WI-185.....3600.....5.....10.....9
WI-185V.....3600.....5.....10.....9
WI-340.....3600.....9.....20.....17
WI-390.....3600.....11.....22.....19
WI-588.....3600.....16.....34.....29

**VOLKSWAGON**

026.2.....2200.....70.....140.....1150.....417
068.5.....4000.....48.....90.....900.....227
068.A.....4000.....60.....120.....900.....302
075.1.....4000.....75.....145.....900.....365
126A.....2000.....45.....90.....1150.....268

**VOLVO**

D45BPP.....2300.....75.....195.....900.....491
TD100G.....2000.....223.....460.....900.....1159
TD100GPP.....2000.....223.....460.....900.....1159
TD120HP.....2000.....286.....575.....900.....1448
TD121G.....2000.....284.....575.....900.....1448
TD45B.....2200.....90.....235.....900.....592
TD61A.....2500.....154.....330.....900.....831
TD61AP.....2500.....165.....350.....900.....881
TD61AW.....2500.....162.....350.....900.....881
TD71A.....2200.....189.....360.....900.....907
TD71AP.....2200.....192.....360.....900.....907
TD71AW.....2400.....190.....360.....900.....907
TID100KPP.....2000.....249.....515.....900.....1297
TID121KP.....2000.....343.....695.....900.....1750
TID121LP.....1800.....401.....800.....900.....2015
TID71A.....2200.....216.....380.....900.....957
TID71AP.....2200.....209.....400.....900.....1007

Engine Model	RPM	HP	-- Exhaust --	
			Intake Temp. (°F)	Flow (CFM)

**WAUKESHA**

190DLC.....2800.....84.....128.....109
197DLC.....2800.....91.....208.....177
197DLCs.....2800.....131.....320.....273
D317D.....2400.....118.....285.....243
D317DS.....2400.....142.....340.....290
F1197D.....1800.....258.....620.....528
F1197DS.....1800.....400.....960.....818
F1197DSI.....2400.....462.....1100.....937
F1905DS.....1200.....397.....860.....733
F1905DSI.....2200.....514.....1015.....865
F2896D.....1200.....415.....804.....685
F2896DS.....1200.....695.....1032.....879
F2896DSI.....1200.....877.....1305.....1112
F475D.....2400.....182.....440.....375
F475DS.....2400.....216.....520.....443
F674D.....2200.....226.....540.....460
F674DS.....2200.....229.....550.....469
H1077D.....2400.....346.....630.....537
H1077DS.....2400.....522.....1080.....920
H1077DSI.....2400.....557.....1190.....1014
H866DS.....2300.....384.....920.....784
L1616D.....2400.....520.....940.....801
L1616DS.....2400.....785.....1680.....1431
L1616DSI.....2400.....836.....1850.....1576
L5100D.....1200.....830.....1420.....1210
L5100DS.....1200.....1232.....2170.....1849
L5100DSI.....1200.....1375.....2560.....2181
L5790D.....1200.....905.....1710.....1457
L5790DS.....1200.....1235.....2600.....2215
L5790DSI.....1200.....1754.....3080.....2624
LRDCS.....1200.....695.....1032.....879
NKDC.....1200.....297.....566.....482
NKDCS.....1200.....390.....860.....733
P2154D.....2200.....592.....1420.....1210
P2154DS.....2200.....1017.....2450.....2087
P2154DSI.....2200.....1077.....2600.....2215
VLRD.....1200.....905.....1710.....1457
VLRDS.....1200.....1235.....2600.....2215
VRD232.....2200.....68.....160.....136
VRD283.....2200.....76.....180.....153
VRD310.....2400.....106.....255.....217
WAKD.....1800.....258.....530.....451
WAKDS.....1800.....400.....810.....690

Engine Model	RPM	HP	-- Exhaust --	
			Intake Temp. (°F)	Flow (CFM)

**WHITE ENG**

D-2000.....2600.....70.....120.....102
D-2300.....2400.....137.....117
D-2300T.....2400.....211.....180
D-3000.....2800.....110.....193.....164
D-3000T.....2600.....130.....280.....239
D-3300T.....1800.....175.....149
D-3400.....2400.....210.....179
D-3400T.....2400.....333.....284
D-4800.....2400.....260.....221
D-4800T.....2400.....400.....341
D-4800TA.....2400.....400.....341
D-4800TAH.....1800.....431.....367
G-1600.....2400.....102.....87
G-2000.....2800.....84.....120.....102
G-2300.....2400.....130.....111
G-3000.....2800.....130.....154
G-3400.....2400.....210.....179

**YANMAR**

12LAAL-DT.....1800.....1060.....2772.....900.....6981
3T95LE.....2800.....51.....114.....900.....287
4HAL.....1800.....110.....260.....900.....655
4T95LE.....2800.....68.....150.....900.....378
4T95LTE.....2800.....85.....208.....900.....524
6HAL.....1800.....165.....390.....900.....982
6HAL-DT.....1800.....330.....837.....900.....2108
6HAL-HT.....1800.....264.....692.....900.....1743
6HAL-T.....1800.....209.....512.....900.....1289
6LAAL-DT.....1800.....530.....1370.....900.....3450
6T95LE.....2800.....102.....233.....900.....587
6T95LTE.....2800.....128.....314.....900.....791
8LAAL-DT.....1800.....705.....1800.....900.....4533



All air cleaner housings and intake accessories featured in this catalog are listed in this section by part number in alpha/numeric order. If you have a part number (for instance, H000466), but don't know what it is, this section will tell you a brief description and the page number where the item can be found in this catalog.

Some descriptions in this section list the first two letters of the air cleaner series name. For instance, ST includes all STB and STG air cleaners; EB includes all EBA and EBB air cleaners; and so on.

If an air cleaner model directs you to the Air Cleaner Service Parts Section, you will be able to find service parts that are still available for an obsolete air cleaner model.

## Abbreviations

- A/C = Air Cleaner Assembly
- HORZ = Horizontal
- ID = Inner Diameter
- OD = Outer Diameter
- PER = Peripheral Inlet
- RS = Rain Shield
- TUB or TUBE = Tubular Inlet
- VERT = Vertical

Part No.	Page No.	Product Description
115305-00005	203	Sensor, Filter Minder, 5" Limit
115305-00040	203	Sensor, Filter Minder, 40" Limit
115375-00002	203	Sensor, Filter Minder, 2" Limit
135501-00820	197	Indicator, Filter Minder, 20" Limit
135501-00825	197	Indicator, Filter Minder, 25" Limit
135578-08420	202	Indicator and Switch, Filter Minder, 20" Limit
135578-08425	202	Indicator and Switch, Filter Minder, 25" Limit
135587-09225	202	Indicator and Switch, Filter Minder, 25" Limit
136501-00520	197	Indicator, Filter Minder, 20" Limit
136501-00525	197	Indicator, Filter Minder, 25" Limit
136578-07820	202	Indicator and Switch, Filter Minder, 20" Limit
136578-07825	202	Indicator and Switch, Filter Minder, 25" Limit
168501-00220	198	Indicator, Dash, Filter Minder, 20" Limit
168501-00225	198	Indicator, Dash, Filter Minder, 25" Limit
175501-00125	199	Indicator, Filter Minder, 25" Limit
175501-00220	199	Indicator, Filter Minder, 20" Limit
175578-10225	202	Indicator and Switch, Filter Minder, 25" Limit
175587-13020	202	Indicator and Switch, Filter Minder, 20" Limit
195389-00120	201	Switch, Filter Minder, 20" Limit
195389-00125	201	Switch, Filter Minder, 25" Limit
196398-11120	201	Switch, Filter Minder, 20" Limit
196398-11125	201	Switch, Filter Minder, 25" Limit

Part No.	Page No.	Product Description
A042511	219-238	Air Cleaner, FGA
A052526	219-238	Air Cleaner, FWA
A052527	219-238	Air Cleaner, FWA
A060022	219-238	Air Cleaner, FGA
A065007	219-238	Air Cleaner, FWA
A065015	219-238	Air Cleaner, FWA
A080022	219-238	Air Cleaner, FWA
A080031	219-238	Air Cleaner, FWA
A092018	219-238	Air Cleaner, EBA-KPI
A092019	219-238	Air Cleaner, EBA-KPII
A092037	80-81	Air Cleaner, EBA Konepac
A100013	219-238	Air Cleaner, FGA
A100017	219-238	Air Cleaner, FWA
A100019	219-238	Air Cleaner, FWA
A110007	219-238	Air Cleaner, EBA-CYL
A110052	75-76	Air Cleaner, ERA RadialSeal
A112018	80-81	Air Cleaner, EBA Konepac
A112078	80-81	Air Cleaner, EBA Konepac
A120003	219-238	Air Cleaner, FWA
A120036	219-238	Air Cleaner, FWA
A127200	219-238	Air Cleaner, FGA
A130045	219-238	Air Cleaner, EBA-CYL
A130060	219-238	Air Cleaner, EBA-CYL
A130087	219-238	Air Cleaner, EBA-CYL
A130115	75-76	Air Cleaner, ERA RadialSeal
A132001	80-81	Air Cleaner, EBA Konepac
A132004	219-238	Air Cleaner, EBA-KPI
A132020	219-238	Air Cleaner, EBA-KPII
A140002	219-238	Air Cleaner, FWA

Part No.	Page No.	Product Description
A140003	219-238	Air Cleaner, FWA
A140033	219-238	Air Cleaner, FWA
A140036	219-238	Air Cleaner, FWA
A144800	219-238	Air Cleaner, FGA
A144900	219-238	Air Cleaner, FGA
A145200	219-238	Air Cleaner, FGA
A150039	219-238	Air Cleaner, EBA-CYL
A150128	219-238	Air Cleaner, EBA-CYL
A150138	75-76	Air Cleaner, ERA RadialSeal
A150141	75-76	Air Cleaner, ERA RadialSeal
A150174	219-238	Air Cleaner, EBA-CYL
A160001	219-238	Air Cleaner, FWA
A160013	219-238	Air Cleaner, FWA
A160173	219-238	Air Cleaner, EBA-CYL
A161500	219-238	Air Cleaner, FGA
A161600	219-238	Air Cleaner, FGA
B045008	99-100	Air Cleaner, FKB
B055006	99-100	Air Cleaner, FKB
B065045	99-100	Air Cleaner, FKB
B080080	107-108	Air Cleaner, XRB
B085001	23-24	Air Cleaner, ECB DuraLite
B085008	23-24	Air Cleaner, ECB DuraLite
B085011	23-24	Air Cleaner, ECB DuraLite
B085046	23-24	Air Cleaner, ECB DuraLite
B085048	23-24	Air Cleaner, ECB DuraLite
B085056	23-24	Air Cleaner, ECB DuraLite
B100001	219-238	Air Cleaner, FWB
B100002	219-238	Air Cleaner, FWB
B100028	219-238	Air Cleaner, STB



Part No.	Page No.	Product Description
B100127	107-108	Air Cleaner, XRB
B105002	23-24	Air Cleaner, ECB DuraLite
B105006	23-24	Air Cleaner, ECB DuraLite
B105020	23-24	Air Cleaner, ECB DuraLite
B120105	219-238	Air Cleaner, EBB-STYB
B120129	219-238	Air Cleaner, STB
B120271	90-91	Air Cleaner, EBB
B120376	23-24	Air Cleaner, ECB DuraLite
B120439	23-24	Air Cleaner, ECB DuraLite
B120470	107-108	Air Cleaner XRB
B125003	23-24	Air Cleaner, ECB DuraLite
B125005	23-24	Air Cleaner, ECB DuraLite
B125011	23-24	Air Cleaner, ECB DuraLite
B140019	219-238	Air Cleaner, STB
B140044	90-91	Air Cleaner, EBB
B140149	219-238	Air Cleaner, EBB-STYB
B140150	219-238	Air Cleaner, EBB-STYB
B160049	90-91	Air Cleaner, EBB
B160071	175-176	Air Cleaner, STB
C045001	23-24	Air Cleaner, ECC DuraLite
C045002	23-24	Air Cleaner, ECC DuraLite
C055002	23-24	Air Cleaner, ECC DuraLite
C055003	23-24	Air Cleaner, ECC DuraLite
C065001	23-24	Air Cleaner, ECC DuraLite
C065002	23-24	Air Cleaner, ECC DuraLite
C065003	23-24	Air Cleaner, ECC DuraLite
C065015	23-24	Air Cleaner, ECC DuraLite
C085001	23-24	Air Cleaner, ECC DuraLite
C085002	23-24	Air Cleaner, ECC DuraLite
C085003	23-24	Air Cleaner, ECC DuraLite
C085004	23-24	Air Cleaner, ECC DuraLite
C085005	23-24	Air Cleaner, ECC DuraLite
C085006	23-24	Air Cleaner, ECC DuraLite
C085041	23-24	Air Cleaner, ECC DuraLite
C085043	23-24	Air Cleaner, ECC DuraLite
C105003	23-24	Air Cleaner, ECC DuraLite
C105004	23-24	Air Cleaner, ECC DuraLite
C105017	23-24	Air Cleaner, ECC DuraLite
C105028	23-24	Air Cleaner, ECC DuraLite
C125004	23-24	Air Cleaner, ECC DuraLite
C125017	23-24	Air Cleaner, ECC DuraLite
D045003	23-24	Air Cleaner, ECD DuraLite
D045004	23-24	Air Cleaner, ECD DuraLite
D055004	23-24	Air Cleaner, ECD DuraLite
D065003	23-24	Air Cleaner, ECD DuraLite
D065008	23-24	Air Cleaner, ECD DuraLite
D080020	34-36	Air Cleaner, PSD, PowerCore®
D080026	34-36	Air Cleaner, PSD, PowerCore®
D080056	34-36	Air Cleaner, PSD, PowerCore®
D090055	34-36	Air Cleaner, PSD, PowerCore®
D090073	34-36	Air Cleaner, PSD, PowerCore®
D090101	34-36	Air Cleaner, PSD, PowerCore®
D090108	48-50	Air Cleaner, PCD, PowerCore®
D090109	48-50	Air Cleaner, PCD, PowerCore®

Part No.	Page No.	Product Description
D090114	48-50	Air Cleaner, PCD, PowerCore®
D090115	48-50	Air Cleaner, PCD, PowerCore®
D090120	34-36	Air Cleaner, PSD, PowerCore®
D090121	34-36	Air Cleaner, PSD, PowerCore®
D100029	34-36	Air Cleaner, PSD, PowerCore®
D100030	34-36	Air Cleaner, PSD, PowerCore®
D100031	34-36	Air Cleaner, PSD, PowerCore®
D100032	34-36	Air Cleaner, PSD, PowerCore®
D100068	34-36	Air Cleaner, PSD, PowerCore®
D100072	34-36	Air Cleaner, PSD, PowerCore®
D100142	48-50	Air Cleaner, PCD, PowerCore®
D100143	48-50	Air Cleaner, PCD, PowerCore®
D100145	48-50	Air Cleaner, PCD, PowerCore®
D100146	48-50	Air Cleaner, PCD, PowerCore®
D120035	34-36	Air Cleaner, PSD, PowerCore®
D120036	34-36	Air Cleaner, PSD, PowerCore®
D120037	34-36	Air Cleaner, PSD, PowerCore®
D120038	34-36	Air Cleaner, PSD, PowerCore®
D140078	219-238	Air Cleaner, PSD, PowerCore®
D140079	219-238	Air Cleaner, PSD, PowerCore®
D140110	34-36	Air Cleaner, PSD, PowerCore®
D140111	34-36	Air Cleaner, PSD, PowerCore®
DBA5002	219-238	Filter, primary - Donaldson Blue®
DBA5007	219-238	Filter, primary - Donaldson Blue®
DBA5008	219-238	Filter, primary - Donaldson Blue®
DBA5015	91	Filter, primary - Donaldson Blue®
DBA5016	219-238	Filter, primary - Donaldson Blue®
DBA5024	81	Filter, primary - Donaldson Blue®
DBA5025	81	Filter, primary - Donaldson Blue®
DBA5026	81	Filter, primary - Donaldson Blue®
DBA5027	86-87	Filter, primary, no cover - Donaldson Blue®
DBA5028	91	Filter, primary - Donaldson Blue®
DBA5029	86-87	Filter primary, no cover - Donaldson Blue®
DBA5034	219-238	Filter, primary - Donaldson Blue®
DBA5043	147	Filter, primary - Donaldson Blue®
DBA5044	165	Filter, primary - Donaldson Blue
DBA5046	219-238	Filter, primary - Donaldson Blue®
DBA5047	86-87	Filter, primary, attached cover - Donaldson Blue®
DBA5049	147	Filter, primary - Donaldson Blue®
DBA5053	86-87	Filter, primary, attached cover - Donaldson Blue®
DBA5054	219-238	Filter, primary - Donaldson Blue®
DBA5059	219-238	Filter, primary - Donaldson Blue®
DBA5067	71	Filter, primary - Donaldson Blue®
DBA5069	71	Filter, primary - Donaldson Blue®
DBA5099	91	Filter, primary - Donaldson Blue®
DBA5105	133-135	Filter, primary - Donaldson Blue®
DBA5109	71	Filter, primary - Donaldson Blue®
DBA5116	133-135	Filter, primary - Donaldson Blue®
DBA5126	219-238	Filter, primary - Donaldson Blue®
DBA5127	219-238	Filter, primary - Donaldson Blue®
DBA5128	219-238	Filter, primary - Donaldson Blue®

Part No.	Page No.	Product Description
DBA5134	219-238	Filter, primary - Donaldson Blue®
DBA5136	219-238	Filter, primary - Donaldson Blue®
DBA5148	76	Filter, primary - Donaldson Blue®
DBA5149	76	Filter, primary - Donaldson Blue®
DBA5150	76	Filter, primary - Donaldson Blue®
DBA5151	76	Filter, primary - Donaldson Blue®
DBA5156	133-135	Filter, primary - Donaldson Blue®
DBA5204	219-238	Filter, primary - Donaldson Blue®
DBA5207	15	Filter, primary - Donaldson Blue®
DBA5220	133-135	Filter, primary - Donaldson Blue®
DBA5221	133-135	Filter, primary - Donaldson Blue®
DBA5222	133-135	Filter, primary - Donaldson Blue®
DBA5223	133-135	Filter, primary - Donaldson Blue®
DBA5224	133-135	Filter, primary - Donaldson Blue®
DBA5225	121	Filter, primary - Donaldson Blue®
DBA5226	121	Filter, primary - Donaldson Blue®
DBA5227	121	Filter, primary - Donaldson Blue®
DBA5228	121	Filter, primary - Donaldson Blue®
DBA5230	133-135	Filter, primary - Donaldson Blue®
DBA5231	133-135	Filter, primary - Donaldson Blue®
DBA5233	219-238	Filter, primary - Donaldson Blue®
DBA5234	219-238	Filter, primary - Donaldson Blue®
DBA5290	19	Filter, primary - Donaldson Blue®
DBA5294	19	Filter, primary - Donaldson Blue®
DBA5291	19	Filter, primary - Donaldson Blue®
DBA5292	19	Filter, primary - Donaldson Blue®
DBA5293	19	Filter, primary - Donaldson Blue®
DBA5306	19	Filter, primary - Donaldson Blue®
DBA5307	19	Filter, primary - Donaldson Blue®
DBA7038	219-238	Filter, primary - Donaldson Blue®
DBA7039	163-165	Filter, primary - Donaldson Blue®
DBA7040	219-238	Filter, primary - Donaldson Blue®
DBA7041	164-165	Filter, primary - Donaldson Blue®
DBA7042	164-165	Filter, primary - Donaldson Blue®
DBA7152	154-156	Filter, primary - Donaldson Blue®
DBA7153	154-156	Filter, primary - Donaldson Blue®
G042503	219-238	Air Cleaner, FWG
G042529	219-238	Air Cleaner, FWG
G042544	117-120	Air Cleaner, FPG RadialSeal
G042545	117-120	Air Cleaner, FPG RadialSeal
G042547	219-238	Air Cleaner, FPG
G042549	219-238	Air Cleaner, FPG
G052510	219-238	Air Cleaner, FWG
G052512	219-238	Air Cleaner, FWG
G052558	219-238	Air Cleaner, FHG-STYA
G052559	219-238	Air Cleaner, FHG-STYA
G052560	219-238	Air Cleaner, FHG-STYA
G052561	219-238	Air Cleaner, FHG-STYA
G052617	219-238	Air Cleaner, FHG-STYA
G052685	131-135	Air Cleaner, FRG RadialSeal
G052686	131-135	Air Cleaner, FRG RadialSeal
G052741	55-56	Air Cleaner, PowerPleat™ 05
G052742	55-56	Air Cleaner, PowerPleat™ 05
G052828	55-56	Air Cleaner, PowerPleat™ 05

Donaldson Blue® = High Efficiency, Extended Service

Part No.	Page No.	Product Description
G052829	55-56	Air Cleaner, PowerPleat™ 05
G057511	117-120	Air Cleaner, FPG RadialSeal
G057512	117-120	Air Cleaner, FPG RadialSeal
G057513	117-120	Air Cleaner, FPG RadialSeal
G057514	117-120	Air Cleaner, FPG RadialSeal
G057516	219-238	Air Cleaner, FPG
G057517	219-238	Air Cleaner, FPG
G060003	219-238	Air Cleaner, SDG-PER
G065008	219-238	Air Cleaner, FWG
G065012	219-238	Air Cleaner, FWG
G065104	219-238	Air Cleaner, FHG-STYA
G065113	219-238	Air Cleaner, FHG-STYA
G065212	219-238	Air Cleaner, FHG-STYA
G065256	219-238	Air Cleaner, FHG-STYA
G065261	219-238	Air Cleaner, FHG-STYB
G065266	219-238	Air Cleaner, FWG
G065359	219-238	Air Cleaner, FHG-STYB
G065360	219-238	Air Cleaner, FHG-STYB
G065411	117-120	Air Cleaner, FPG RadialSeal
G065424	117-120	Air Cleaner, FPG RadialSeal
G065426	219-238	Air Cleaner, FPG
G065427	219-238	Air Cleaner, FPG
G065432	117-120	Air Cleaner, FPG RadialSeal
G065433	117-120	Air Cleaner, FPG RadialSeal
G065541	131-135	Air Cleaner, FRG RadialSeal
G065551	131-135	Air Cleaner, FRG RadialSeal
G070017	117-120	Air Cleaner, FPG RadialSeal
G070018	117-120	Air Cleaner, FPG RadialSeal
G070019	117-120	Air Cleaner, FPG RadialSeal
G070020	117-120	Air Cleaner, FPG RadialSeal
G080009	219-238	Air Cleaner, SBG-PER
G080010	219-238	Air Cleaner, SBG-TUB
G080023	219-238	Air Cleaner, FWG
G080026	219-238	Air Cleaner, FWG
G080147	219-238	Air Cleaner, FHG-STYB
G080195	219-238	Air Cleaner, FHG-STYA
G080200	219-238	Air Cleaner, FHG-STYA
G080372	219-238	Air Cleaner, FHG-STYB
G080490	219-238	Air Cleaner, FHG-STYB
G080491	219-238	Air Cleaner, FHG-STYB
G080582	131-135	Air Cleaner, FRG RadialSeal
G080585	131-135	Air Cleaner, FRG RadialSeal
G082525	117-120	Air Cleaner, FPG RadialSeal
G082526	117-120	Air Cleaner, FPG RadialSeal
G082527	117-120	Air Cleaner, FPG RadialSeal
G082528	117-120	Air Cleaner, FPG RadialSeal
G090022	219-238	Air Cleaner, FHG-STYA
G090024	219-238	Air Cleaner, FHG-STYA
G090182	219-238	Air Cleaner, FHG-STYB
G090183	219-238	Air Cleaner, FHG-STYB
G090219	117-120	Air Cleaner, FPG RadialSeal
G090225	117-120	Air Cleaner, FPG RadialSeal
G090245	131-135	Air Cleaner, FRG RadialSeal
G090250	131-135	Air Cleaner, FRG RadialSeal

Part No.	Page No.	Product Description
G092001	85-87	Air Cleaner, ECG Konepac
G092004	219-238	Air Cleaner, ECG-KPII
G092401	85-87	Air Cleaner, ECG Konepac
G092501	219-238	Air Cleaner, ECG-KPI
G100003	219-238	Air Cleaner, FWG
G100004	219-238	Air Cleaner, FWG
G100028	219-238	Air Cleaner, FHG-STYA
G100029	219-238	Air Cleaner, FHG-STYA
G100035	219-238	Air Cleaner, FHG-STYA
G100036	219-238	Air Cleaner, FHG-STYA
G100160	219-238	Air Cleaner, SBG-PER
G100161	219-238	Air Cleaner, SBG-TUB
G100297	131-135	Air Cleaner, FRG RadialSeal
G100317	117-120	Air Cleaner, FPG RadialSeal
G100319	117-120	Air Cleaner, FPG RadialSeal
G100395	131-135	Air Cleaner, FRG RadialSeal
G100398	131-135	Air Cleaner, FRG RadialSeal
G110103	219-238	Air Cleaner, FTG
G110119	70-71	Air Cleaner, EPG 11" RadialSeal
G110120	70-71	Air Cleaner, EPG 11" RadialSeal
G110206	131-135	Air Cleaner, FRG RadialSeal
G110214	131-135	Air Cleaner, FRG RadialSeal
G110468	62	Air Cleaner, PowerPleat™ 11
G110469	62	Air Cleaner, PowerPleat™ 11
G110474	62	Air Cleaner, PowerPleat™ 11
G110475	62	Air Cleaner, PowerPleat™ 11
G112000	219-238	Air Cleaner, ECG-KPII
G112001	85-87	Air Cleaner, ECG Konepac
G112401	219-238	Air Cleaner, ECG-KPI
G112404	85-87	Air Cleaner, ECG Konepac
G112417	85-87	Air Cleaner, ECG Konepac
G112501	85-87	Air Cleaner, ECG Konepac
G112504	85-87	Air Cleaner, ECG Konepac
G120012	219-238	Air Cleaner, FHG-STYA
G120014	219-238	Air Cleaner, FHG-STYA
G120036	219-238	Air Cleaner, FHG-STYA
G120037	219-238	Air Cleaner, FHG-STYA
G120059	219-238	Air Cleaner, FWG
G120063	219-238	Air Cleaner, FWG
G120075	219-238	Air Cleaner, STG-PER
G120250	219-238	Air Cleaner, SBG-PER
G120251	219-238	Air Cleaner, SBG-TUB
G120332	163-165	Air Cleaner, STG Donaclone Tubular
G120415	131-135	Air Cleaner, FRG RadialSeal
G120417	131-135	Air Cleaner, FRG RadialSeal
G130043	219-238	Air Cleaner, FTG
G130079	70-71	Air Cleaner, EPG 13" RadialSeal
G130089	70-71	Air Cleaner, EPG 13" RadialSeal
G130097	131-135	Air Cleaner, FRG RadialSeal
G130107	131-135	Air Cleaner, FRG RadialSeal
G130372	61-62	Air Cleaner, PowerPleat™ 13
G130373	61-62	Air Cleaner, PowerPleat™ 13
G130374	61-62	Air Cleaner, PowerPleat™ 13
G130375	61-62	Air Cleaner, PowerPleat™ 13

Part No.	Page No.	Product Description
G132000	85-87	Air Cleaner, ECG Konepac
G140022	219-238	Air Cleaner, FHG-STYA
G140023	219-238	Air Cleaner, FHG-STYA
G140054	219-238	Air Cleaner, FHG-STYA
G140055	219-238	Air Cleaner, FHG-STYA
G140076	163-165	Air Cleaner, STG Donaclone Peripheral
G140083	219-238	Air Cleaner, FWG
G140195	146-147	Air Cleaner, FVG Cycloflow
G140260	219-238	Air Cleaner, SBG-PER
G140261	219-238	Air Cleaner, SBG-TUB
G140270	219-238	Air Cleaner, SBG-PER
G140523	131-135	Air Cleaner, FRG RadialSeal
G140526	131-135	Air Cleaner, FRG RadialSeal
G150039	219-238	Air Cleaner, FTG
G150048	70-71	Air Cleaner, EPG 15" RadialSeal
G150049	70-71	Air Cleaner, EPG 15" RadialSeal
G150092	131-135	Air Cleaner, FRG RadialSeal
G160035	219-238	Air Cleaner, SBG-TUB
G160048	219-238	Air Cleaner, FHG-STYA
G160049	219-238	Air Cleaner, FHG-STYA
G160057	219-238	Air Cleaner, FHG-STYA
G160077	163-165	Air Cleaner, STG Donaclone Peripheral
G160078	219-238	Air Cleaner, FHG-STYA
G160104	219-238	Air Cleaner, FWG
G160107	219-238	Air Cleaner, FWG
G160158	219-238	Air Cleaner, STG-TUB
G160254	219-238	Air Cleaner, FHG-STYA
G160331	219-238	Air Cleaner, SBG-TUB
G160340	219-238	Air Cleaner, SBG-PER
G160359	219-238	Air Cleaner, SBG-PER
G160376	146-147	Air Cleaner, FVG Cycloflow
G160443	219-238	Air Cleaner, STG-PER
G160445	163-165	Air Cleaner, STG Donaclone Tubular
G160587	146-147	Air Cleaner, FVG Cycloflow
G160679	131-135	Air Cleaner, FRG RadialSeal
G161006	163-165	Air Cleaner, STG Donaclone Peripheral
G161020	163-165	Air Cleaner, STG Donaclone Tubular
G180031	131-135	Air Cleaner, FRG RadialSeal
G200008	219-238	Air Cleaner, SRG Donaclone, Vertical
G200013	219-238	Air Cleaner, SRG Donaclone, Vertical
G200016	219-238	Air Cleaner, SRG
G200086	154-156	Air Cleaner, SSG Donaclone, RadialSeal
G200087	154-156	Air Cleaner, SSG Donaclone, RadialSeal
G200088	154-156	Air Cleaner, SSG Donaclone, RadialSeal
G210007	140-141	Air Cleaner, FTG Cycloflow
G210010	140-141	Air Cleaner, FTG Cycloflow
G290000	219-238	Air Cleaner, SRG Donaclone, Vertical
G290001	219-238	Air Cleaner, SRG
G290010	219-238	Air Cleaner, SRG
G290012	219-238	Air Cleaner, SRG Donaclone, Vertical
G290023	219-238	Air Cleaner, SRG Donaclone, Vertical
G290052	154-156	Air Cleaner, SSG Donaclone, RadialSeal
G290053	154-156	Air Cleaner, SSG Donaclone, RadialSeal
G290055	154-156	Air Cleaner, SSG Donaclone, RadialSeal

Part No.	Page No.	Product Description
G290057	154-156	Air Cleaner, SSG Donaclone, RadialSeal
H000165	193	Inlet Hood, metal
H000170	193	Inlet Hood, metal
H000275	193	Inlet Hood, metal
H000276	193	Inlet Hood, metal
H000339	193	Inlet Hood, metal
H000349	194	Mounting Band
H000350	194	Mounting Band
H000351	194	Mounting Band
H000466	193	Inlet Hood, plastic
H000467	193	Inlet Hood, plastic
H000468	193	Inlet Hood, plastic
H000469	193	Inlet Hood, plastic
H000470	193	Inlet Hood, plastic
H000471	193	Inlet Hood, plastic
H000472	193	Inlet Hood, plastic
H000473	193	Inlet Hood, plastic
H000483	218	Air Stack Extension
H000484	218	Air Stack Extension
H000604	193	Inlet Hood, plastic
H000605	193	Inlet Hood, ST 12" Tube A/C
H000606	193	Inlet Hood, plastic
H000607	193	Inlet Hood, plastic
H000672	176	Pre-Cleaner Hood Assembly-STB
H000722	215	Ejector Check Valve
H000820	189	Pre-Cleaner, Full-View
H000821	189	Pre-Cleaner, Full-View
H000823	189	Pre-Cleaner, Full-View
H000858	189	Pre-Cleaner, Full-View
H000875	191	In-Line, Horizontal Separator
H000878	191	In-Line, Vertical Separator
H000886	191	In-Line, Vertical Separator
H001009	176	Pre-Cleaner Body Assembly-STB
H001023	215	Ejector Check Valve
H001053	193	Inlet Hood, plastic
H001063	193	Inlet Hood, plastic
H001200	216	Air Ram, Low Profile
H001212	190	Donaspin P/C & Exhaust Ejector, 3" ID
H001215	190	Donaspin P/C & Exhaust Ejector, 4.50" ID
H001220	191	In-Line Separator, Vertical, 8"
H001249	189	Pre-Cleaner, Full-View
H001250	189	Pre-Cleaner, Full-View
H001251	189	Pre-Cleaner, Full-View
H001308	190	DonaSpin P/C & Exhaust Ejector, 5" ID
H001375	190	DonaSpin P/C & Exhaust Ejector, 6" ID
H001377	193	Inlet Hood, plastic, 2" OD
H001378	193	Inlet Hood, plastic, 3" OD
H001379	193	Inlet Hood, plastic, 3.5" OD
H001474	191	In-Line Separator, Horizontal, 4"
H001654	216	Air Ram, Louvered
H001660	216	Air Ram, Louvered
H001661	216	Air Ram, Louvered
H001742	193	Inlet Hood, Bright SSTL, 7" OD
H001756	193	Inlet Hood, Bright SSTL Low Profile, 6" ID

Part No.	Page No.	Product Description
H001773	193	Inlet Hood, EB A132020 A/C
H001823	189	Pre-Cleaner, Full-View
H001906	191	In-Line Separator, Horizontal
H001946	193	Inlet Hood, Bright Stainless, 8" OD
H001947	193	Inlet Hood, Bright Stainless, 7" OD
H001948	193	Inlet Hood, Bright Stainless, 6" OD
H002023	119	Mounting Band
H002040	189	Pre-Cleaner, Full-View
H002042	189	Pre-Cleaner, Full-View
H002043	189	Pre-Cleaner, Full-View
H002044	189	Pre-Cleaner, Full-View
H002045	189	Pre-Cleaner, Full-View
H002068	193	Inlet Hood, plastic, 1.75"
H002070	119	Mounting Band, metal
H002223	189	Pre-Cleaner, Full-View
H002224	189	Pre-Cleaner, Full-View
H002394	185	Pre-Cleaner, TopSpin™
H002425	185	Pre-Cleaner, TopSpin™
H002426	185	Pre-Cleaner, TopSpin™
H002427	185	Pre-Cleaner, TopSpin™
H002431	185	Pre-Cleaner, TopSpin™
H002432	185	Pre-Cleaner, TopSpin™
H002433	185	Pre-Cleaner, TopSpin™
H002434	185	Pre-Cleaner, TopSpin™
H002435	185	Pre-Cleaner, TopSpin™
H002436	185	Pre-Cleaner, TopSpin™
H002437	185	Pre-Cleaner, TopSpin™
H002438	185	Pre-Cleaner, TopSpin™
H002439	185	Pre-Cleaner, TopSpin™
H002612	37, 215	Exhaust Ejector
H002613	37, 215	Exhaust Ejector
H002614	37, 215	Exhaust Ejector
H002615	37, 215	Exhaust Ejector
H002616	37, 215	Exhaust Ejector
H002617	37, 215	Exhaust Ejector
H002618	37, 215	Exhaust Ejector
H002619	37, 215	Exhaust Ejector
H002700	181-182	Pre-Cleaner, Strata™ Cap
H002704	181-182	Pre-Cleaner, Strata™ Cap
H002762	37, 215	Exhaust Ejector
H002763	37, 215	Exhaust Ejector
H002764	37, 215	Exhaust Ejector
H002765	37, 215	Exhaust Ejector
H002766	37, 215	Exhaust Ejector
H002767	37, 215	Exhaust Ejector
H002768	37, 215	Exhaust Ejector
H002769	37, 215	Exhaust Ejector
H002850	187	Pre-Cleaner, TopSpin™ HD
H002851	187	Pre-Cleaner, TopSpin™ HD
H002852	187	Pre-Cleaner, TopSpin™ HD
H002853	187	Pre-Cleaner, TopSpin™ HD
H002854	187	Pre-Cleaner, TopSpin™ HD
H002855	187	Pre-Cleaner, TopSpin™ HD
H002856	187	Pre-Cleaner, TopSpin™ HD

Part No.	Page No.	Product Description
H002857	187	Pre-Cleaner, TopSpin™ HD
H008441	119	Mounting Band, 8mm Threaded Holes
H008442	119	Mounting Band, metal
H008443	119	Mounting Band, metal
H008444	119	Mounting Band, metal
H770037	194	Mounting Band, metal
H770068	194	Mounting Band, metal
H770082	193	Inlet Hood
P002348	194	Mounting Band, 5.25" ID A/C
P002351	194	Mounting Band, 6" ID A/C
P003245	194	Mounting Band, 7.75" ID A/C
P004073	194	Mounting Band, metal
P004076	194	Mounting Band, 10.19" ID A/C
P004079	194	Mounting Band, metal
P004307	194	Mounting Band, 8" ID A/C
P004906	194	Mounting Band, 7" ID A/C
P007189	194	Mounting Band, 4" ID A/C
P007191	194	Mounting Band, 6.5" ID A/C, ST 10" PC
P013722	194	Mounting Band, metal
P016330	189	Bowl Assembly, PB 3", 3.75", 4" & 4.5" OD, P/C
P016548	189	Cover Assembly, PB 3", 3.75", 4", 4.5" OD, P/C
P016845	194	Mounting Band
P016972	164	Gasket Kit for Cover OF ST 14" A/C
P017281	154-156	Cover chain
P017283	154-156	Chain connector
P017365	165	Cover Gasket SB, ST 12" A/C
P017367	164	Cover Gasket SB, ST 16" A/C
P017617	164	Latch, Over Center
P020115	189	Bowl Assembly, PB 1.38"-2" OD, P/C
P020116	189	Cover Assembly, PB P/C, 1.38"-2" OD
P020227	189	Bowl Assembly, PB 2"-3" OD, P/C
P020344	189	Bowl Assembly, PB 4", 4.5", 5.0" OD, P/C
P020345	189	Cover Assembly, PB P/C 4", 4.5", 5.0" OD
P020648	189	Cover Assembly, PB P/C, 2"-3" OD
P100089	204	Restriction Tap for Safety Filter Fitting
P100780	164	Body Clamp Assembly
P100794	164	Dust Cup for STG Air Cleaners
P100808	154-156	Clamp Assembly, FH, FW, SB, SR, SS A/C
P100860	164	Dust Cup, STG
P101290	207	Rubber Hump Reducer, 3.5"/3" ID
P101291	207	Rubber Hump Reducer, 4"/3" ID
P101292	207	Rubber Hump Reducer, 4"/3.5" ID
P101293	207	Rubber Hump Reducer, 5"/4" ID
P101294	207	Rubber Hump Reducer, 6"/5.5" ID
P101759	164	Inlet Shroud, ST 16" Peripheral A/C
P101891	207	Rubber Hump Reducer, 5.5"/4" ID
P102820	207	Rubber Hump Reducer 3"/2.5" ID
P102870	164	Inlet Shroud, ST 14" Peripheral A/C
P102948	208	Rubber Reducer, 2"/1.75" ID
P103198	211	Vacuator™ Valve 30 Durometer, 3" Dia.
P103516	207	Rubber Hump Reducer, 5.5"/5" ID
P103530	163-165	Dust Cup, Horz w/VacValve, SB/ST 16" RS/Tube A/C
P104087	208	Rubber Reducer, 2"/1.5" ID

Part No.	Page No.	Product Description
P104088	208	Rubber Reducer, 2.25"/2" ID
P104089	208	Rubber Reducer, 2.5"/2" ID
P104090	208	Rubber Reducer, 2.5"/2.25" ID
P104691	189	Cover Assembly, PB P/C 6"-7" OD
P104973	164	Dust Cup w/Vac Valve, STG
P105220	211	Vacuator™ Valve, 60 Durometer
P105529	206	Rubber 90° Elbow, 2" ID
P105530	206	Rubber 90° Elbow, 2.25" ID
P105531	206	Rubber 90° Elbow, 2.5" ID
P105532	206	Rubber 90° Elbow, 3" ID
P105533	206	Rubber 90° Elbow, 4" ID
P105534	206	Rubber 90° Elbow, 5.5" ID
P105535	206	Rubber 90° Elbow, 6" ID
P105536	206	Rubber 90° Elbow, 7" ID
P105541	207	Rubber 45° Elbow, 2" ID
P105542	207	Rubber 45° Elbow, 2.25" ID
P105543	207	Rubber 45° Elbow, 2.5" ID
P105544	207	Rubber 45° Elbow, 3" ID
P105545	207	Rubber 45° Elbow, 4" ID
P105546	207	Rubber 45° Elbow, 5.5" ID
P105547	207	Rubber 45° Elbow, 6" ID
P105548	207	Rubber 45° Elbow, 7" ID
P105608	208	Rubber Straight Hump, 3" ID
P105609	208	Rubber Straight Hump, 4" ID
P105610	208	Rubber Straight Hump, 5" ID
P105611	208	Rubber Straight Hump, 5.5" ID
P105612	208	Rubber Straight Hump, 6" ID
P105613	208	Rubber Straight Hump, 7" ID
P105622	204	Remote Mnt, 90° Elb Rest Tap. Fitting
P106329	133-135	Air Cleaner Baffle Assembly, FRG
P106593	211	Vacuator™ Valve 60 Durometer
P106637	133-135	Air Cleaner Baffle Assembly
P106771	133-135	Air Cleaner Baffle Assembly
P106952	133-135	Dust Cup/Cover
P107375	163-165	Quick Release Dust Cup, SB, SR, ST A/C
P107377	163-165	Quick Release Dust Cup, SB, ST 16" A/C
P107844	206	Rubber 90° Elbow, 5" ID
P109021	207	Rubber 45° Elbow, 5" ID
P109062	163-165	Wing Nut
P109107	146-147	Pin
P109153	163-165	Cover Assembly, ST 16" A/C
P109296	133-135	Vacuator Dust Cup
P109297	133-135	Vacuator Dust Cup
P109331	207	Rubber 45° Elbow, 3.5" ID
P110875	163-165	Air Cleaner Body Assembly
P111414	208	Rubber Straight Hump, 10" ID
P112605	206	Rubber 90° Elbow, 8" ID
P112606	207	Rubber 45° Elbow, 8" ID
P112607	207	Rubber Hump Reducer, 10"/8" ID
P112608	208	Rubber Straight Hump, 8" ID
P112609	207	Rubber Hump Reducer, 8"/7" ID
P112610	207	Rubber Hump Reducer, 7"/6" ID
P112611	207	Rubber Hump Reducer, 6"/5" ID
P112789	219-238	Gasket, Quick Release Dust Cup

Part No.	Page No.	Product Description
P112803	211	Vacuator™ Valve 40 Durometer
P113733	206	Rubber 90° Elbow, 4.5" ID
P114313	207	Rubber 45° Elbow, 10" ID
P114314	206	Rubber 90° Elbow, 10" ID
P114315	207	Rubber Hump Reducer, 8"/6" ID
P114316	207	Rubber 45° Elbow, 4.5" ID
P114317	208	Rubber Straight Hump, 4.5" ID
P114318	206	Rubber 90° Elbow, 3.5" ID
P114319	208	Rubber Straight Hump, 3.5" ID
P114931	163-165	Filter, safety
P115023	164	Lower Body Assembly, ST, SB 16" RS A/C
P115070	219-238	Filter, safety
P115096	154-156	Gasket, Body for SSG, SRG AC
P115098	154-156	Gasket, Body for SSG, SRG AC
P115110	154-156	SRG, SSG AC lower body assembly
P115200	195	Clamp, Hose-type Lined
P115201	195	Clamp, Hose-type Lined
P115202	195	Clamp, Hose-type Lined
P115203	195	Clamp, Hose-type Lined
P115204	195	Clamp, Hose-Type Lined High Torque
P115205	195	Clamp, Hose-Type Lined High Torque
P115206	195	Clamp, Hose-Type Lined High Torque
P115207	195	Clamp, Hose-Type Lined High Torque
P115208	195	Clamp, Hose-Type Lined High Torque
P115209	195	Clamp, Hose-Type Lined High Torque
P116175	146-147	Wing Nut for FV A/C
P116446	146-147	Filter, safety
P117724	206	Rubber 90° Elbow Reducer, 5.5"/6" ID
P117781	219-238	Filter, safety
P117785	154-156	Lower Body Assembly, SSG, SRG A/C
P117791	154-156	Gasket, SR, SSG A/C
P118552	154-156	SSG AC lower body assembly
P119325	76	Nut, Plastic for E Series A/C
P119370	164	Filter, safety
P119371	164	Filter, safety
P119463	76	Bolt
P119874	156	Intake/Rain Shield for SS, SR 29" A/C
P119875	156	Intake/Rain Shield for SS, SR 29" A/C
P119876	155	Intake/Rain Shield for SS, SR 20" A/C
P119877	156	Intake/Rain Shield for SS, SR 29" A/C
P120279	133-135	Cover
P120604	86-87	Gasket, Cover
P121067	133-135	Clamp Assembly, FH, FR 12" A/C
P121482	206	Rubber 90° Elbow Reducer, 4"/5" ID
P122067	204	Restriction Tap Filter Fitting
P123462	206	Rubber 90° Elbow Reducer, 3"/3.5" ID
P124860	146-147	Filter, safety
P124866	146-147	Filter, safety
P124867	146-147	Filter, primary
P126530	207	Rubber Hump Reducer, 7"/5.5" ID
P127009	219-238	Clamp, pre-cleaner body
P128408	163-165	Filter, safety
P128990	206	Rubber 90° Elbow Reducer, 5.5"/7" ID

Part No.	Page No.	Product Description
P129396	81	Filter, primary, treated
P129469	76	Retaining Ring
P129472	81	Filter, primary, treated
P129660	207	Rubber Hump Reducer, 8"/5.5" ID
P133338	207	Rubber 45° Elbow Reducer, 5.5"/6" ID
P133339	207	Rubber 45° Elbow Reducer, 6"/7" ID
P134534	204	Water Manometer Kit
P136494	207	Rubber Hump Reducer, 7"/5" ID
P140822	81	Filter, primary
P141228	81	Filter, primary
P142100	86-87	Filter, primary, no cover
P143422	195	Clamp, Lined Hose-Type
P143895	206	Rubber 90° Elbow Reducer, 5"/6" ID
P148043	86-87	Filter, primary, treated
P148044	86-87	Filter, primary, no cover, treated
P148337	195	Clamp, T-bolt, 2" ID
P148338	195	Clamp, T-bolt, 2.25" ID
P148339	195	Clamp, T-bolt, 2.5" ID
P148340	195	Clamp, T-bolt, 2.75" ID
P148341	195	Clamp, T-bolt, 3" ID
P148342	195	Clamp, T-bolt, 3.5" ID
P148343	195	Clamp, T-bolt, 4" ID
P148344	195	Clamp, T-bolt, 4.5" ID
P148345	195	Clamp, T-bolt, 5" ID
P148346	195	Clamp, T-bolt, 5.5" ID
P148347	195	Clamp, T-bolt, 6" ID
P148348	195	Clamp, T-bolt, 7" ID
P148349	195	Clamp, T-bolt, 8" ID
P148350	195	Clamp, T-bolt, 10" ID
P149099	211	Vacuator™ Valve, 1" EBA, EBB A/C
P150692	86-87	Filter, primary, no cover
P150693	86-87	Filter, primary, attached cover
P150694	86-87	Filter primary
P150695	86-87	Filter primary
P150862	86-87	Access Cover, ECG Konepac 11" A/C
P151097	81	Filter, primary
P153551	86-87	Filter primary, attached cover
P154575	86-87	Filter primary, no cover, treated
P154927	26-27	Air Cleaner, ECO®-II
P155211	76	Gasket, Cover
P155264	76	Gasket, Cover
P158089	154-156	SSG AC, dust cup
P158324	189	Bowl Assembly, PB 7" OD, P/C
P158914	211	Vacuator™ Valve
P159820	206	Rubber 90° Elbow Reducer, 7"/5" ID
P181015	91	Filter, primary - SM
P181028	91	Filter, primary - SM
P181038	219-238	Filter, primary - SM
P181039	163-165, 176	Filter, primary - SM
P181040	219-238	Filter, primary - SM
P181041	163-165	Filter, primary - SM
P181042	163-165	Filter, primary - SM

SM=Scheduled Maintenance



Part No.	Page No.	Product Description
P181043	146-147	Filter, primary - SM
P181044	163-165	Filter, primary - SM
P181049	146-147	Filter, primary - SM
P181099	91	Filter, primary - SM
P182015	91	Filter, primary
P182028	91	Filter, primary
P182038	219-238	Filter, primary
P182039	176	Filter, primary - ES
P182040	219-238	Filter, primary
P182041	163-165	Filter, primary
P182042	163-165	Filter, primary
P182043	146-147	Filter, primary
P182044	163-165	Filter, primary
P182049	146-147	Filter, primary
P182099	91	Filter, primary
P206849	218	Aluminum Intake Tubing
P206850	218	Aluminum Intake Tubing
P206851	218	Aluminum Intake Tubing
P207367	218	Aluminum Intake Tubing
P207368	218	Aluminum Intake Tubing
P207369	218	Aluminum Intake Tubing
P224684	218	Aluminum Intake Tubing
P224691	218	Aluminum Intake Tubing
P520882	207	Rubber Hump Reducer, 3.5"/2.75" ID
P520883	207	Rubber Hump Reducer, 3"/2.75" ID
P520884	207	Rubber Hump Reducer, 4"/2.75" ID
P521639	204	Restriction Tap Sleeve, 5"
P521641	204	Restriction Tap Sleeve, 6"
P522133	133-135	Cover, FRG
P522439	194	Mounting Band Bright, 13" ID
P522958	211	Vacuator™ Valve, 2"
P523096	71	Cover, EPG
P524552	194	Mounting Band, Bright Stainless, EB 15" AC
P524837	26-27	Air Cleaner, ECO®-II
P524838	26-27	Air Cleaner, ECO®-II
P525956	211	Vacuator™ Valve, 1"
P526676	133-135	Cover Gasket, FRG
P527435	71	Thumb Screw
P527484	71	Filter, primary - SM
P527586	26-27	Air Cleaner, ECO®-CM
P527680	71	Filter, safety
P527682	71	Filter, primary - SM
P527683	71	Filter, safety
P528722	26-27	Air Cleaner, ECO®-II
P529151	71	Cover, EPG
P532503	133-135	Filter, primary
P532504	133-135	Filter, safety
P532919	195	Clamp, Lined Hose-Type
P532920	195	Clamp, Lined Hose-Type
P532921	195	Clamp, Lined Hose-Type
P532922	195	Clamp, Lined Hose-Type
P532923	195	Clamp, Lined Hose-Type
P532924	195	Clamp, Lined Hose-Type
P532925	195	Clamp, Constant Torque Hose-Type

Part No.	Page No.	Product Description
P532926	195	Clamp, Constant Torque Hose-Type
P532927	195	Clamp, Constant Torque Hose-Type
P532928	195	Clamp, Constant Torque Hose-Type
P532929	195	Clamp, Constant Torque Hose-Type
P532943	209	Silicone 4-ply Bellows
P532944	209	Silicone 4-ply Bellows
P532945	209	Silicone 4-ply Bellows
P532948	209	Silicone Charged Air Connector
P532949	209	Silicone Charged Air Connector
P532950	209	Silicone Charged Air Connector
P532951	209	Silicone Charged Air Connector
P532952	209	Silicone Charged Air Connector
P532953	209	Silicone Charged Air Connector
P532954	209	Silicone Charged Air Connector
P532956	209	Silicone Charged Air Connector
P532957	209	Silicone Charged Air Connector
P532958	209	Silicone Charged Air Connector
P532959	209	Silicone Charged Air Connector
P532960	209	Silicone Hump Hose Connector
P532961	209	Silicone Hump Hose Connector
P532962	209	Silicone Hump Hose Connector
P532966	133-135	Filter, primary
P533685	121	Cover Assembly, FPG
P533761	121	Cover Assembly, FPG
P533781	133-135	Filter, safety
P533890	71	Filter, safety
P533916	71	Service Cover, EPG
P533930	71	Filter, primary
P534048	121	Cover Assembly, FPG
P535396	121	Filter, safety
P535559	76	Gasket, Cover
P535571	209	Silicone 4-ply Bellows
P535572	209	Silicone 4-ply Bellows
P535573	209	Silicone 4-ply Bellows
P536163	206	Rubber 90° Elbow Reducer, 3"/4" ID
P536202	121	Cover Assembly
P536439	133-135	Latch
P536457	133-135	Filter, primary
P536492	133-135	Filter, safety
P536493	86-87	Gasket, Cover
P537308	133-135	Cover Gasket
P537447	26-27	Air Cleaner, ECOLITE®
P537448	26-27	Air Cleaner, ECOLITE®
P537449	26-27	Air Cleaner, ECOLITE®
P537450	26-27	Air Cleaner, ECO®-CM
P537451	26-27	Air Cleaner, ECO®
P537452	26-27	Air Cleaner, ECO®
P537453	26-27	Air Cleaner, ECO®
P537454	26-27	Air Cleaner, ECO®
P537455	26-27	Air Cleaner, ECO®-SM
P537456	26-27	Air Cleaner, ECO®-SM
P537468	206	Rubber 90° Elbow Reducer, 5"/6" ID
P537699	133-135	Gasket Cover
P537791	86-87	Filter primary attached black cover

Part No.	Page No.	Product Description
P537877	133-135	Filter, safety
P538200	133-135	Cover Assembly
P538259	133-135	Cover Assembly
P538452	133-135	Service Cover
P538928	121	Cover Latch
P539422	121	Cover Assembly
P540256	207	Rubber Hump Reducer, 4.5"/4" ID
P542475	76	Cover
P544238	76	Cover
P544243	76	Filter, primary
P544301	76	Filter, primary
P544741	76	Filter, primary
P544744	76	Cover
P544827	76	Cover
P544950	76	Filter, primary
P547694	208	Elbow, 90 Deg, Reducer, Rubber, Cobra Adapter
P549271	133-135	Filter, primary
P549277	133-135	Filter, safety
P549523	133-135	Filter, primary
P549530	133-135	Filter, safety
P600043	133-135	Filter, primary
P600047	133-135	Filter, safety
P600321	133-135	Cover
P600325	208	Elbow, 90 Deg, Reducer, Rubber, Cobra Adapter
P600326	208	Elbow, 90 Deg, Reducer, Rubber, Cobra Adapter
P600327	208	Elbow, 90 Deg, Reducer, Rubber, Cobra Adapter
P600328	208	Elbow, 90 Deg, Reducer, Rubber, Cobra Adapter
P600657	133-135	Cover
P600975	42	Filter, safety
P601280	133-135	Filter, primary
P601286	133-135	Filter, safety
P601437	133-135	Filter, primary
P601476	133-135	Filter, safety
P601560	42	Filter, safety
P601735	42	Cover
P601767	133-135	Filter, primary
P601774	133-135	Filter, safety
P601790	133-135	Filter, primary
P602211	133-135	Baffle Assembly
P602427	100	Filter, safety
P602985	42	Cover
P603504	154-156	Body gasket strips (two, short)
P603505	154-156	Lower body assembly
P603716	154-156	Cover
P603729	100	Filter, safety
P604045	207	Rubber Hump Reducer, 5"/4.5" ID
P604457	100	Filter, primary
P605731	108	Cover
P606121	42	Filter, safety
P606497	100	Cover

SM=Scheduled Maintenance

Part No.	Page No.	Product Description
P606503	21	Filter, primary
P607373	26-27	Air Cleaner, ECO®
P607557	42	Filter, safety
P608116	108	Filter, primary (metal liner)
P608117	108	Cover
P608171	42	Cover
P608180	42	Cover
P608305	154-156	Filter, safety RadialSeal
P608306	154-156	Filter, primary RadialSeal
P608391	108	Filter, safety
P608533	42	Filter, primary
P608592	100	Cover
P608599	100	Filter, safety
P608665	42	Filter, primary
P608666	42	Filter, primary
P608667	42	Filter, primary
P608675	42	Filter, primary
P608676	42	Filter, primary
P608676	42	Filter, primary
P608677	42	Filter Primary
P608766	17	Filter Primary
P609218	100	Filter Primary
P609219	100	Cover
P609221	100	Filter Primary
P609508	154-156	Lower body assembly
P609239	21	Filter, safety
P609518	154-156	Filter, safety RadialSeal
P609519	154-156	Filter, primary RadialSeal
P609942	108	Cover
P610776	154-156	Rain shroud, right side
P610777	154-156	Rain shroud, left side
P611189	108	Filter, safety
P611190	108	Filter, primary (metal liner)
P611539	108	Filter, primary (metal liner)
P611540	108	Filter, safety
P613334	21	Filter, primary
P613335	21	Filter, safety
P613336	21	Filter, primary
P613337	21	Filter, safety
P613679	26-27	Air Cleaner, ECO®
P615493	42	Filter, Safety
P615530	42	Cover
P616641	21	Filter, primary
P617276	37	Scavenge Adapter, 90 Deg
P617631	42	Filter, Primary
P617632	211	Vacuator™ Valve
P617643	21	Filter, primary
P617644	21	Filter, safety
P617645	21	Filter, safety
P617646	21	Filter, primary
P619481	42	Cover, Watertight
P619482	42	Cover, Watertight
P621983	42	Filter, primary
P621984	42	Filter, safety
P622745	42	U-clip (9 clips)

Part No.	Page No.	Product Description
P622945	219-238	Latch
P623026	42	Cover, with watertight seal
P623192	42	Gasket
P625983	63	O-ring
P626094	63	Cover
P626096	63	Filter, primary
P626104	63	Filter, safety
P627756	63	Cover
P627758	63	O-ring
P627763	63	Filter, primary
P628203	63	Filter, safety
P628323	21	Filter, primary
P628324	21	Filter, primary
P628325	21	Filter, primary
P628326	21	Filter, primary
P628327	21	Filter, primary
P628328	21	Filter, primary
P628170	57	Filter, safety
P628329	21	Filter, primary
P628390	57	Filter, primary
P628588	57	Cover
P628802	63	Filter, safety
P628805	63	Filter, primary
P628862	63	Filter, safety
P628866	63	Filter, primary
P629463	21	Filter, safety
P629464	21	Filter, safety
P629465	21	Filter, safety
P629466	21	Filter, safety
P629467	21	Filter, safety
P629468	21	Filter, safety
P629469	21	Filter, safety
P629526	42	Latch
P629543	13	Filter, primary
P629991	195	Clamp, T-bolt, 8.25" ID
P633483	19	Filter, safety
P633484	19	Filter, safety
P633871	205	LED Display
P633872	205	LED Display
P633873	205	LED Display
P633874	205	Wire Harness Adapter
P633875	205	Wire Harness Adapter
P633876	205	EPDM Hose, 3'
P633877	205	EPDM Hose, 20'
P633878	205	EPDM Hose, 10'
P633879	205	Remote Mount Bracket
P633880	204	Fitting, 1/8-27 NPT x 3/8-24 UNF with Filter and Orifice
P633881	204	Fitting, 1/8-27 NPT Male to Hose Barb with Filter
P635903	17	Filter, primary
P635904	17	Filter, primary
P635979	17	Filter, safety
P635980	17	Filter, safety

Part No.	Page No.	Product Description
P638061	19	Filter, primary
P638062	19	Filter, primary
P776008	211	Vacuator™ Valve
P776033	42	Latch
P777151	119	Mounting Band, plastic, FPG 04
P777366	42	Latch, Air Cleaner
P777639	133-135	Filter, safety
P777730	119	Mounting Band, plastic
P777731	119	Mounting Band, plastic
P777732	119	Mounting Band, polymer
P777868	133-135	Filter, primary
P777869	133-135	Filter, safety
P777920	133-135	Cover
P778810	119	Mounting Band, polymer
P778972	15	Filter, primary
P778979	15	Filter, primary
P778984	15	Filter, primary
P778989	15	Filter, primary
P778994	15	Filter, primary
P780012	15	Filter, safety
P780018	15	Filter, safety
P780024	15	Filter, safety
P780030	15	Filter, safety
P780036	15	Filter, safety
P780522	121	Filter, primary
P780523	121	Filter, safety
P780532	119	Mounting Band, FPG Alexin
P780594	119	Mounting Band, FPG Alexin
P781039	133-135	Filter, primary
P781098	133-135	Filter, primary
P781102	133-135	Filter, safety
P782104	15	Filter, primary
P782105	15	Filter, primary
P782106	15	Filter, primary
P782107	15	Filter, safety
P782108	15	Filter, safety
P782109	15	Filter, safety
P782328	15	Filter, primary
P782880	15	Filter, primary
P782881	15	Filter, primary
P782936	15	Filter, primary
P782937	15	Filter, safety
P783185	133-135	Cover
P783746	37	Scavenge Adapter, Straight
P783747	37	Scavenge Adapter, Straight
P783748	37	Scavenge Adapter, Straight
P784198	21	Filter, primary
P784456	21	Filter, primary
P784457	21	Filter, primary
P784525	21	Filter, primary
P785352	21	Filter, primary
P786421	21	Filter, primary
P789377	21	Filter, primary

Part No.	Page No.	Product Description
P784019	37	Scavenge Adapter, 90 Deg
P784279	42	Cover
P784298	42	Cover
P784517	42	U-clip (4 clips)
P785651	42	Cover
P785965	17	Filter, safety
P786337	38	Check Valve
P786340	38	Check Valve
P786343	38	Check Valve
P786989	42	Cover
P821575	121	Filter, primary
P822686	121	Filter, primary
P822768	121	Filter, primary
P822769	121	Filter, safety
P822858	121	Filter, safety
P827653	121	Filter, primary
P828889	121	Filter, primary
P829332	121	Filter, safety
P829333	121	Filter, safety
S000011	218	Breather, 1/4" NPT
S000067	218	Breather, 1.50" ID
S000072	218	Breather, 1/2" NPT
S000080	218	Breather, 3/4" NPT
S000099	218	Breather, 2" NPT
S000183	218	Breather, 1" NPT
X001744	218	Air Stack Extension
X001746	218	Air Stack Extension
X001747	218	Air Stack Extension
X001966	192	Inlet Hood, metal, 2.5" OD
X001988	192	Inlet Hood, metal, 3.75" OD
X002014	192	Inlet Hood, metal, 3" OD
X002015	192	Inlet Hood, metal, 4" OD
X002017	192	Inlet Hood, metal, 1.75" OD
X002018	192	Inlet Hood, metal, 2" OD
X002019	192	Inlet Hood, metal, 2.25" OD
X002101	198	Restriction Gauge Kit, Informer, 30" Limit
X002102	198	Restriction Gauge Kit, Informer, 25" Limit
X002103	198	Restriction Gauge Kit, Informer, 20" Limit
X002215	200	Restriction Indicator, 15" Limit
X002220	200	Restriction Indicator, 20" Limit
X002225	200	Restriction Indicator, 25" Limit
X002230	200	Restriction Indicator, 30" Limit
X002250	200	Restriction Indicator, ServiSignal, 15" Limit
X002251	200	Restriction Indicator, ServiSignal, 20" Limit
X002252	200	Restriction Indicator, ServiSignal, 25" Limit
X002254	200	Restriction Indicator, ServiSignal, 30" Limit
X002275	198	Restriction Gauge, Informer, 30" Limit
X002277	198	Restriction Gauge, Informer, 25" Limit
X002278	198	Restriction Gauge, Informer, 20" Limit
X002315	200	Restriction Indicator Kit, 15" Limit
X002320	200	Restriction Indicator Kit, 20" Limit
X002325	200	Restriction Indicator Kit, 25" Limit
X002330	200	Restriction Indicator Kit, 30" Limit
X002350	200	Restriction Indicator Kit, ServiSignal, 15"

Part No.	Page No.	Product Description
		Limit
X002351	200	Restriction Indicator Kit, ServiSignal, 20" Limit
X002352	200	Restriction Indicator Kit, ServiSignal, 25" Limit
X002354	200	Restriction Indicator Kit, ServiSignal, 30" Limit
X002700	198	Restriction Gauge Kit, 60" H <sub>2</sub> O
X002730	198	Restriction Gauge Kit, 30" H <sub>2</sub> O
X003538	164-165	Gasket Kit, ST 14" Tube/Peripheral
X003539	164-165	Gasket Kit, ST 16" Tube/Peripheral
X003691	217	Moisture Eliminator, Vertical, 7" Dia.
X004814	203	Indicator, Safety Signal, 7/16"-20 UNF
X004815	203	Indicator, Safety Signal, 7/16"-20 UNF
X004816	203	Indicator, Safety Signal, 1/2"-13 UNF
X005555	164-165	Latch Repair Kit
X005822	217	In-Line Moisture Skimmer, 6" Dia.
X005900	217	In-Line Moisture Skimmer, 7" Dia.
X005901	217	In-Line Moisture Skimmer, 7" Dia.
X006452	71	Fastener Kit
X006561	212-213	Dust Dumpa
X006562	212-213	Dust Dumpa with Dust Cup
X007276	199	Mini-Informer Kit, 25" H <sub>2</sub> O
X007335	199	Mini-Informer, Restriction Indicator, 25" H <sub>2</sub> O
X009230	169	SRG/SSG Conversion Kit
X009231	169	SRG/SSG Conversion Kit
X009291	86-87	Latch Replacement Kit
X009701	169	SRG/SSG Conversion Kit
X009702	169	SRG/SSG Conversion Kit
X011861	19	Filter Kit, primary - Donaldson Blue®
X011872	19	Filter Kit, safety
X770037	201	Restriction Electrical Indicator, 15" Limit
X770050	201	Restriction Electrical Indicator, 20" Limit
X770062	201	Restriction Electrical Indicator, 25" Limit
X770075	201	Restriction Electrical Indicator, 20" Limit

Part No.	Page No.	Product Description
----------	----------	---------------------

# Hydraulic & Transmission Filtration for Mobile Equipment

Donaldson offers a complete line of hydraulic and transmission filtration solutions that will keep your equipment operating at peak performance.

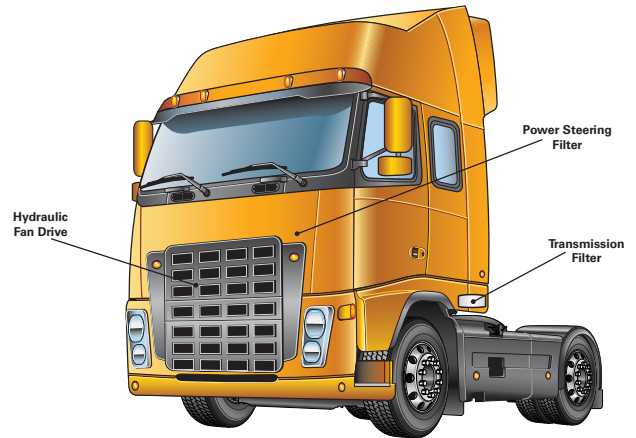
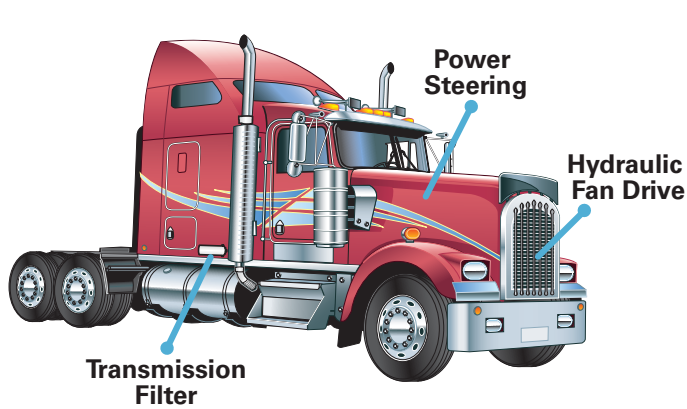
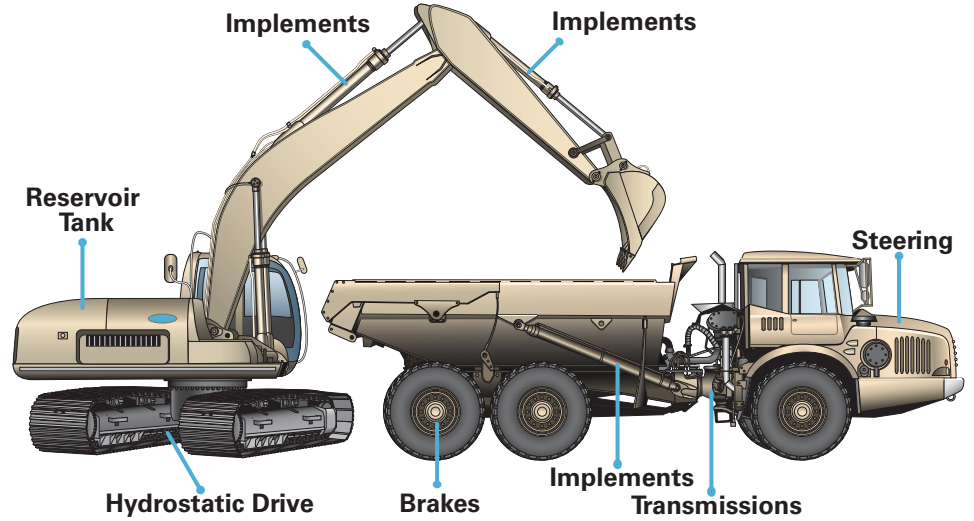

Single-pass Bulk Fuel Filtration System

## Bulk Fuel & Lubricant Filtration

Donaldson offers a range of custom and standard filtration products and services specifically targeted to resolve fuel and bulk oil filtration problems, including:

- On-site surveys
- Facility upgrade options
- Condition monitoring
- Contamination control training/audit
- Installation support, commissioning and fluid management systems
- Achieve target ISO cleanliness levels in a single pass to meet OEM specifications.
- Support from a local Donaldson distributor for replacement filters and spare parts.



## Air Cleaner Selection Steps — see pages 10, 11 inside for complete details.

1. Determine the combustion air requirements of the engine
2. Determine the dust condition for the engine/machine and typical operating environment
3. Select an air cleaner series
4. Choose a specific air cleaner family or series
5. Choose intake accessories

## Engine Displacement Formula

### 4-Stroke (Cycle) Engine Formula

English Units

$$\text{Airflow (CFM)} = (\text{Engine Size (CID)} \times \text{RPM}) \times \text{VE} / 3456$$

Metric Units

$$\text{Airflow (m}^3\text{/min)} = (\text{Engine Size (Liters)} \times \text{RPM}) \times \text{VE} / 2000$$

VE = Volumetric Efficiency — 4-Stroke\*

0.90 for naturally aspirated gas engine

0.90 for naturally aspirated diesel engine

1.60 for turbo charged diesel engine

1.85 for turbo charged after cooled diesel engine

### 2-Stroke (Cycle) Engine Formula

English Units

$$\text{Airflow (CFM)} = (\text{Engine Size (CID)} \times \text{RPM}) \times \text{VE} / 1728$$

Metric Units

$$\text{Airflow (m}^3\text{/min)} = (\text{Engine Size (Liters)} \times \text{RPM}) \times \text{VE} / 1000$$

VE = Volumetric Efficiency — 2-Stroke\*

0.90 for naturally aspirated diesel engine

1.40 for scavenge blower diesel engine

1.90 for turbo charged diesel engine

## Engine Horsepower Formula

English Units

$$\text{Airflow (CFM)} = \text{HP (SAE)} \times \text{SA}$$

SA = (Specific Airflow) per Horsepower

4-stroke naturally aspirated diesel engine — 2.0

4-stroke turbo charged diesel engine — 2.3

4-stroke turbo charged after cooled diesel engine — 2.3

2-stroke naturally aspirated diesel engine — 2.0

2-stroke scavenge blower diesel engine — 3.3

2-stroke turbo charged diesel engine — 3.6

Metric Units

$$\text{Airflow (m}^3\text{/min)} = \text{HP (SAE)} \times \text{SA}$$

SA = (Specific Airflow) per Horsepower

4-stroke naturally aspirated diesel engine — 0.057

4-stroke turbo charged diesel engine — 0.065

4-stroke turbo charged after cooled diesel engine — 0.065

2-stroke naturally aspirated diesel engine — 0.057

2-stroke scavenge blower diesel engine — 0.093

2-stroke turbo charged diesel engine — 0.102

# How to Read Air Cleaner Performance Curves

## Performance Curve Explanation & Conversions

**B055006**

*Air Cleaner Model Number*

*More than one model may be on a chart. Notations will be added for models with safety or for scavenge systems.*

*Restriction (inches of H<sub>2</sub>O) at Tap.*

*Tap is the restriction indicator tap located on the air cleaner outlet.*

*Convert inches of H<sub>2</sub>O to . . .*  
*inches of Hg — Multiply by 0.076*  
*mm of Hg — Multiply by 1.8682*  
*Kg/m<sup>2</sup> — Multiply by 25.3985*  
*millibars — Multiply by 2.4907*

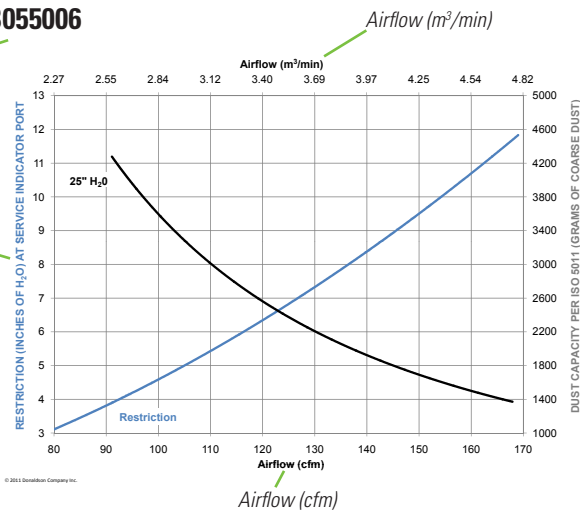

*Dust Capacity per ISO 5011 (grams of Coarse Dust)*

*Coarse Dust = 1g/m<sup>3</sup> dust concentration*

*Airflow conversion calculations*

*1 Cubic Foot per Minute (cfm) = 0.0283 Cubic Meters per Minute (m<sup>3</sup>/min)*

*1 Cubic Meters per Minute (m<sup>3</sup>/min) = 35.315 Cubic Feet per Minute (cfm)*

## To determine the Restriction of an air cleaner . . .

- 1) Find the desired airflow in either cfm or m<sup>3</sup>/min on the horizontal axis. (Red Arrows)  
 cfm = cubic feet per minute (cfm)  
 m<sup>3</sup>/min = cubic meters per minute
- 2) Find the clean air cleaner restriction level (in inches of H<sub>2</sub>O) on the vertical left hand axis that intersects with the airflow level on the blue restriction curve. (Green Arrow)

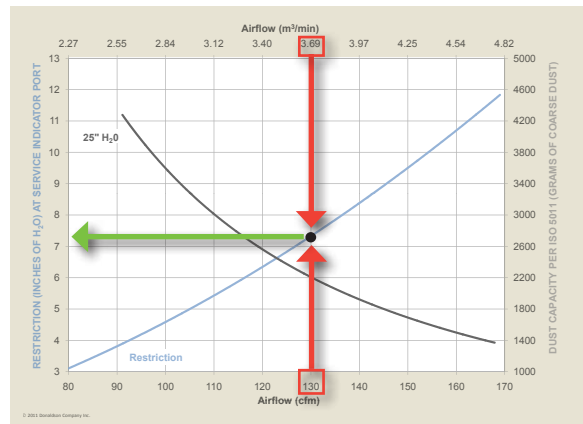

## To determine the Dust Capacity of an air cleaner

. . .

- 1) Find the desired airflow in either cfm or m<sup>3</sup>/min on the horizontal axis. (Red arrows)  
 cfm = cubic feet per minute (cfm)  
 m<sup>3</sup>/min = cubic meters per minute
- 2) Follow the point on the H<sub>2</sub>O black curve to the right hand axis in the chart. The axis intersect point is the "Dust Capacity" in grams at the stated H<sub>2</sub>O restriction. (Orange Arrow)

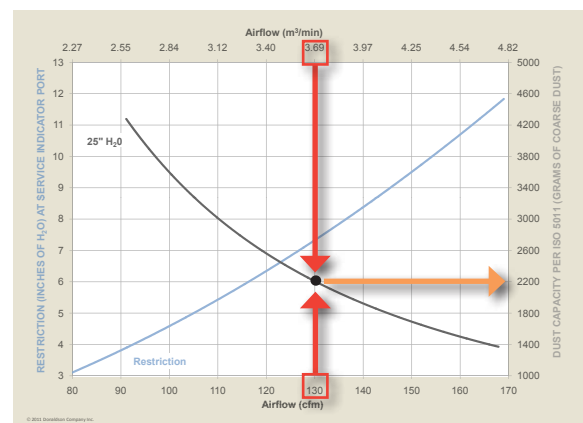

# Global Presence with a Local Touch

At Donaldson, we've built a strong, flexible and responsive distribution network to serve our customers around the world.

**Localized Manufacturing** – It starts with 30+ manufacturing locations around the world – producing most filters in the regions where they're used.

**Primary Distribution Centers** – Filters then move to our regional warehouses and distribution center hubs – meaning the filters you need are never far away.

**Logistics** – We work with a network of transportation and logistics companies, consolidators and cross-docking facilities to deliver products to distribution partners quickly and efficiently.

**Distribution Partners** – We've built one of the largest, strongest and most responsive distributor networks in the filter industry – meaning you can find the filters and support you need, nearly anywhere in the world.



**AMERICAS, EUROPE,  
SOUTH AFRICA AND ASIA PACIFIC  
CROSS REFERENCE**



[catalog.donaldson.com](http://catalog.donaldson.com)

**AUSTRALIA  
CROSS REFERENCE**



[donaldsontoolbox.com.au](http://donaldsontoolbox.com.au)



**Donaldson Company, Inc.**  
Minneapolis, MN USA

[www.buydonaldson.com](http://www.buydonaldson.com)  
[www.donaldson.com](http://www.donaldson.com)

**North America** 800-374-1374  
**Mexico, Latin America &  
Caribbean** 52-449-910-6150  
**Brazil** 55-11-2119-1604  
**Europe** 32-16-38-3811

**South Africa** 27-11-997-6000  
**South East Asia** 65-6311-7373  
**Greater China** 852-2405-8388  
**Japan** 81-42-540-4112  
**Korea** 82-2-517-3333  
**Australia** 61-02-4350-2033  
**India** 91-124-2290060

**Catalog No. F110027 ENG (5/20)**

© 2020 Donaldson Company, Inc. All rights reserved. Donaldson Company, Inc. reserves the right to change or discontinue any model or specification at any time and without notice. Printed in the U.S.A.